



# GRIFFITHS EQUIPMENT

— AUTOMOTIVE & MARINE ACCESSORIES —



EDITION 62

## WHO WE ARE

Griffiths Equipment Ltd is proud to have over 60 years experience with an exciting and innovative range of automotive products.

## QUALITY ACCREDITATION

We are committed to the supply of the world's best and most innovative automotive products. The prestigious ISO9001 certification is proof of our commitment to a continuous improvement program.



## OUR COMMITMENT

Griffiths Equipment Ltd is committed to being a leading supplier of quality automotive products and services which consistently satisfies the needs and expectations of our customers. Through our reliability, competitive prices, integrity and friendliness our company strives for excellence in both our business practice and work ethic. We grow our business through the continual introduction of innovative products and services. To achieve these objectives, we will empower our people, invest in their development and live by our catchphrase "Keeping our customers delighted".



- 2022** Developed and released Jelly Jets air freshener range.  
Launched new range of Rain-X brushware.  
Type S and Jelly Jets websites go live. New 2022 catalogue released.
- 2021** Dirty Steve vehicle and marine products released.  
Released the new Hot Wheels air freshener range.  
Appointed New Zealand distributor for KT Cables and KT Solar products.  
Type S app controlled LED lighting range launched.
- 2020** Appointed New Zealand distributor for Lynx automotive air freshener.  
Worldwide Covid-19 pandemic struck.
- 2019** Moved to new distribution centre in Bell Ave, Mt Wellington - 84,000 sq ft.  
Now stocking the Clarion audio range.
- 2018** ISO9001:2015 accreditation.  
Appointed New Zealand distributor for MAP remotes.
- 2017** Striker innovative hardware and automotive accessories launched.
- 2016** Acquired by GUD Holdings Limited. Exclusive distributor for Kicker car audio.
- 2015** Appointed New Zealand distributor for J-B Weld.
- 2014** Appointed New Zealand distributor for Jelly Belly automotive air freshener.
- 2013** Now stocking the entire Aerpro audio range.  
Our sales representatives use tablets as their main selling tool.  
Appointed New Zealand distributor for K-Seal.
- 2012** Upgraded website to include fully integrated webstore.  
Appointed New Zealand distributor for Blue Magic USA.
- 2011** Appointed New Zealand distributor for TDJ Australia.  
Appointed New Zealand distributor for ProQuip Australia.  
Commenced scanning all outwards orders. ISO9001:2008 accreditation.
- 2010** Wildcat car mat ranged launched.
- 2009** Yada Bluetooth hands-free kits launched.
- 2008** T-Max 4x4 range of winches and accessories launched.
- 2007** Type S and Black Out window tint ranges launched.
- 2006** Appointed All Blacks licensee for automotive accessories.
- 2004** Appointed Disney licensee for automotive category for New Zealand.  
Acquired the Saas brand.
- 2003** Appointed NZ distributor for Victor steering wheels from Italy.  
Appointed NZ distributor for Simoni Racing from Italy.
- 2002** Appointed Americas Cup 2003 automotive licensee.  
Appointed Team Kiwi Racing automotive licensee.
- 2001** Type S range of automotive accessories launched. Carplan range launched.
- 2000** Signalmaster/Antech Technologies aerial company acquired.  
Hotwire range of audio accessories launched.

- 1999** Appointed Americas Cup 2000 automotive licensee.  
No. 1 Warner Bros licensee in New Zealand.  
Alpena window tint launched – immediately to No. 1 in NZ.
- 1997** Appointed Warner Bros Looney Tune automotive licensee.  
Launched website.
- 1996** ISO 9002 accreditation.
- 1994** Exclusive distributor for 3M abrasion film and pinstriping.
- 1993** Joint venture with Narva New Zealand Ltd.
- 1992** Cheviot brand of alloy wheels acquired.
- 1991** Moved to expanded premises at 22-24 Olive Road, Penrose – 24,000 sq ft.  
Exclusive distributor for Club steering lock – television launch.
- 1990** Wildcat White Steel Wheels launched.
- 1988** Exclusive distributor for Auto Fashions, Australia.
- 1986** Cardboard sunshades launched, the beginning of NZ's largest sunshade program.
- 1985** Wildcat steering wheels launched.
- 1984** Commenced assembly of Wildcat chrome wheels.
- 1983** Moved to own premises at 7 Fairfax Avenue, Penrose – 8,000 sq ft.  
First computer system.
- 1982** Exclusive distributor for Aunger Plastics Pty Ltd. First fax machine.
- 1981** Wildcat spoilers launched.
- 1979** Exclusive distributor for Speco Thomas, first of many Australian companies.
- 1978** First Telex machine.
- 1977** Acquired by Peter Griffiths.  
Wildcat alloy wheels launched.
- 1973** Launched one of the first ranges of alloy wheels in the world manufactured by a subsidiary company.
- 1971** Opened the first tuning shop for motoring addicts and was involved with many race and rally cars.
- 1970** Wildcat brand included manifolds, headers, mufflers, floorshifts and air cleaners.
- 1969** Moved to own premises in Albert St, Auckland – 2,500 sq ft.
- 1960** Griffiths Equipment Ltd commenced business as a performance subsidiary of Griffiths Motors Ltd. The Wildcat brand originated in 1960. It started when Rootes Group first fitted their outstanding 1500cc OHV engine into the Hillman. This saloon car proved a winner on the circuits and quickly created a demand for increased performance. Griffiths Equipment started producing twin carb manifolds for this engine and introduced a floorshift gear change conversion to replace the existing column shift. This was extensively used by both family and sporting motorists.



## LICENSED PRODUCTS

Page .....6-7



## AUDIO

Page ..... 8-101



## INTERIOR ACCESSORIES

Page ..... 102-123



## WORKSHOP CONSUMABLES

Page ..... 124-147



## CAR CARE

Page ..... 148-163



## INTERIOR COVERINGS

Page ..... 164-179

## EXTERIOR ACCESSORIES

Page ..... 180-239



## VEHICLE SAFETY

Page ..... 240-249



## ELECTRICAL

Page ..... 250-285



## EV CHARGERS & ACCESSORIES

Page ..... 286-295



## SOLAR PANELS & CONTROLLERS

Page ..... 296-349



## MARINE

Page ..... 350-373



**ALL BLACKS**



**52 ABRJ015** OCEAN BREEZE AIR FRESHENER  
**11 ABSS419** FRONT FOLDING SUNSHADE  
**55 ABSC170** FRONT PAIR CAR SEAT COVERS  
**14 ABFM850** BLACK CARPET MATS SET OF 4  
**14 ABRM019** FRONT RUBBER CAR FLOOR MATS  
**49 ABSW550** STEERING WHEEL COVER



**49 ABBP190** SEAT BELT PAD  
**45 ABNP217** NUMBER PLATE FRAME  
**18 ZSTLWBAB** SEE-THRU DECAL  
**18 ZBDSAB** BUMPER DECALS  
**18 ZMLBVAB** MEGA DECAL BLACK  
**18 ZMLWVAB** MEGA DECAL WHITE

**R.M. Williams THE RUGBY OUTFITTER**



**11 WSRM17LH** FRONT FOLDING SUNSHADE  
**55 CVRMW16BLK30** CANVAS FRONT SEAT COVERS BLACK SIZE 30  
**55 CVRMW16GRY30** CANVAS FRONT SEAT COVERS GREY SIZE 30  
**55 JCRMW16BLK30** JACQUARD FRONT SEAT COVERS BLACK SIZE 30  
**55 JCRMW16BLK60** JACQUARD FRONT SEAT COVERS BLACK SIZE 60  
**55 MHRMW16BLK06** MESH BACK SEAT COVER BLACK SIZE 06



**55 MHRMW16BLK30** MESH FRONT SEAT COVERS BLACK SIZE 30  
**55 VLRMW16BLK06** VELOUR REAR SEAT COVERS BLACK SIZE 06  
**55 VLRMW16BLK30** VELOUR FRONT SEAT COVERS BLACK SIZE 30  
**14 CMRMCBLK4** BLACK CARPET MATS SET OF 4  
**14 CMRMWBLKFR** FRONT RUBBER CAR FLOOR MATS  
**49 SWRMWBLK** BLACK LEATHER STEERING WHEEL COVER WHITE TRIM



**18 STRMWBLK** LONGHORN DECAL BLACK  
**18 STRMWBNE** LONGHORN DECAL BONE  
**18 STRMWPNK** LONGHORN DECAL PINK  
**18 STRMWRED** LONGHORN DECAL RED  
**18 STRMWSLV** LONGHORN DECAL SILVER  
**18 STRMWWHT** LONGHORN DECAL WHITE

**CAT**



**11 WSCATCHP** FRONT FOLDING SUNSHADE  
**55 CVCATBLK30** CANVAS FRONT SEAT COVER PAIR BLACK SIZE 30  
**55 PCCATGRY30** POLYESTER CANVAS FRONT SEAT COVER PAIR BLACK SIZE 30  
**14 CMCATBLKFR** FRONT RUBBER CAR FLOOR MATS  
**49 SWCATBLK** BLACK LEATHER STEERING WHEEL COVER

**HOT WHEELS AIR FRESHENERS**



**52 AF532320F** REDLINE REAR VIEW MIRROR MOUNT  
**52 AF532321F** BURNOUT REAR VIEW MIRROR MOUNT  
**52 AF532322F** TREASURE HUNT REAR VIEW MIRROR MOUNT  
**52 AF532323F** BEACH BOMB REAR VIEW MIRROR MOUNT  
**52 AF532324F** RODGER DODGER REAR VIEW MIRROR MOUNT  
**52 AF532325F** SILVER BULLET REAR VIEW MIRROR MOUNT



**52 AF532326F** REDLINE VENT MOUNT  
**52 AF532327F** BURNOUT VENT MOUNT  
**52 AF532328F** TREASURE HUNT VENT MOUNT  
**52 AF532329F** BEACH BOMB VENT MOUNT  
**52 AF532330F** RODGER DODGER VENT MOUNT

**ALL BLACKS**

Air Freshener .....111  
 Sunshade .....121  
 Seat Covers .....168  
 Carpet Car Mats .....175  
 Rubber Car Mats .....177  
 Steering Wheel Cover .....184  
 Decals .....222  
 Number Plate Frame .....229

**R.M. WILLIAMS**

Sunshade .....121  
 Seat Covers .....169  
 Carpet Car Mats .....175  
 Rubber Car Mats .....177  
 Steering Wheel Cover .....184  
 Decals .....222

**CATERPILLAR**

Sunshade .....121  
 Seat Covers .....168  
 Rubber Car Mats .....177  
 Steering Wheel Cover .....184

**HOT WHEELS**

Air Freshener .....109



## AUDIO

- Kicker Subwoofers ..... 10
- Kicker Subwoofer Grilles ..... 11
- Kicker Subwoofer Enclosures ..... 12
- Kicker QS Speakers ..... 14
- Kicker Component Speakers ..... 15
- Kicker KS Speakers ..... 16
- Kicker CS Speakers ..... 18
- Kicker Marine Speakers ..... 20
- Kicker Marine Enclosures ..... 20
- Kicker Amplifiers ..... 22
- Kicker Accessories ..... 23
- Kicker Marine Amplifiers ..... 24
- Kicker Media Receivers & Controllers ..... 25
- Kicker Outdoor Speakers ..... 25
- Clarion Headunits ..... 26
- Clarion Headphones ..... 26
- Clarion Screens ..... 26
- Clarion Speakers ..... 27
- Clarion Amplifiers ..... 27
- Hertz Media Receivers ..... 28
- Hertz Subwoofers ..... 28
- Hertz Speakers ..... 29
- Hertz Amplifiers ..... 31
- Audison Subwoofers ..... 32
- Audison Speakers ..... 35
- Audison Amplifiers ..... 40
- Facias and Pockets ..... 43
- Sound Proofing ..... 56
- FM Transmitters & Accessories ..... 58
- Aerials ..... 60
- Headunit Aerial Adaptors ..... 68
- Band Expanders ..... 69
- CB UHF Aerials ..... 75
- CB UHF Brackets ..... 75
- CB UHF Aerial Leads ..... 77
- Harnesses ..... 78
- Patch Leads ..... 86
- USB Leads ..... 90
- Steering Wheel Control Interface ..... 90
- Speaker Lead Adaptors ..... 91
- Reverse Camera Retention Harnesses ..... 92
- Speaker Spacers ..... 94
- Subwoofer Boxes ..... 95
- Speaker Boxes ..... 95
- Speaker Grilles ..... 95
- Audio Accessories ..... 96
- Speaker Cables ..... 99
- Wiring Kits ..... 99
- RCA Leads ..... 100
- Home Audio ..... 101



**KICKER  
15IN 1000W L7 SOLO BARIC  
SUBWOOFER 4-OHM**

The KICKER Solo-Baric L7S boasts massive power handling and more cone area than any circular sub. You move more air, so you get more bass. The heavy-duty motor structure includes a large-diameter spider for less flex, longer life and superior accuracy.

- Dual Four-Ohm Voice Coils
- Injection-Molded Polypropylene Cone
- Patented Corner Ribs Minimize Distortion
- SoloKon 360-Degree Back Bracing
- Ribbed Santoprene Surround With Blue Surround Stitching
- UniPlate Back Plate And Pole Piece, Plus Perimeter Venting For Excellent Thermal Management
- Large Ceramic Magnet
- Cast Aluminum Basket
- Satin-Nickel Plated, Spring-Loaded Speaker Terminals.

PRODUCT CODE  
**80 44L7S154**



**KICKER  
12IN 600W SUBWOOFER  
WITH DUAL 2-OHM VOICE COILS**

It's simple - more cone means more air moves. KICKER's L7R Square Sub technology gives you up to 20% more cone area than a round sub. The L7R's powerful motor delivers big bass, while utilizing next-level thermal management for optimal performance.

- The L7R 12-Inch Subwoofer works best with 600 watts of recommended power in a sealed or ported enclosure.
- The engineers at KICKER HQ designed the L7R to give you more bass than a circular sub, without a larger enclosure.

PRODUCT CODE  
**80 45L7R122**

**KICKER  
15IN 900W RMS SUBWOOFER  
WITH DUAL 2-OHM VOICE COILS**

KICKER's L7R Square Sub technology gives you up to 20% more cone area than a round sub. The L7R's powerful motor delivers big bass, while utilizing next-level thermal management for optimal performance. The full 360-degree back bracing keeps the entire cone strong and stable for smooth, distortion-free bass.

- Dual 2-Ohm voice coil.
- Patented ribbed corners.
- 360-degree back bracing.
- Nickel plated speaker terminals.
- UniPlate back plate and pole piece.
- Bumped back plate.
- Large ceramic magnet.

PRODUCT CODE  
**80 45L7R152**



**KICKER  
10IN 800W COMPRT 2-OHM  
ULTRA THIN SUBWOOFER**

The only thing thin about the CompRT Subwoofer is the mounting depth. Whether it's on the road, sand or trail, these tough subs work perfectly in nearly anything with a motor. The CompRT 10-Inch Subwoofer is an all-weather thin subwoofer.

- All-weather thin subwoofer
- Custom SoloKon technology
- 10in subwoofer
- 2 Ohm

PRODUCT CODE  
**80 43CWRT102**

**KICKER  
12IN 1000W COMPRT 2-OHM  
ULTRA THIN SUBWOOFER**

The only thing thin about the CompRT® Subwoofer is the mounting depth. Whether it's on the road, sand or trail, these tough subs work perfectly in nearly anything with a motor. Your car's back dash. The bags on your bike. Behind your ATVs seats.

- The CompRT 12-Inch Subwoofer is an all-weather thin mount subwoofer with a 2 Ohm dual voice coil design for superior wiring flexibility.
- The CompRT is designed for the sound quality audiophiles want, with the weatherproof performance powersports enthusiasts need. Only KICKER is truly able to deliver the best of both worlds.
- The CompRT 12-Inch Subwoofer works best with a sealed or ported enclosure and 500 watts of recommended power.

PRODUCT CODE  
**80 43CWRT122**



**KICKER  
10IN 400W SUBWOOFER  
WITH DUAL VOICE COILS**

Now even more efficient and sporting a slick, blacked-out look, the CompR sub is the very model of power and reliability. The CompR 10-Inch Subwoofer is a dual voice coil design, making it easy to get the most out of your amp.

- Works best with 400 watts of recommended power
- Peak: 800W, RMS: 400W

PRODUCT CODE  
**80 48CWR102 2 OHM**  
**80 48CWR104 4 OHM**

**KICKER  
12IN 500W SUBWOOFER  
WITH DUAL VOICE COILS**

- Works best with 500 watts of recommended power
- Peak: 1000W, RMS: 500W.

PRODUCT CODE  
**80 48CWR122 2 OHM**  
**80 48CWR124 4 OHM**

**KICKER  
15IN 800W SUBWOOFER  
WITH DUAL 2-OHM VOICE COILS**

The CompR sub is the very model of power and reliability.

- With a double stacked magnet, the CompR provides powerful bass and a thunderous low-end response for the thump you crave when the volume knob needs a workout.
- Our signature, red double stitching makes an outstanding bond between the improved Santoprene surround and polypropylene woofer cone.
- Every CompR includes two sets of brass voice-coil terminals, spring-loaded and covered in a lustrous satin nickel finish.

PRODUCT CODE  
**80 48CWR152**



**KICKER  
10IN 400W SUBWOOFER  
WITH DUAL 2-OHM VOICE COILS**

The only thing thin about the CompRT Subwoofer is the mounting depth. Whether its on the road, sand or trail, these tough subs work perfectly in nearly anything with a motor. The CompRT 10-Inch Subwoofer is an all-weather thin subwoofer with a pair of 2-Ohm voice coils.

- All-weather thin subwoofer
- Custom SoloKon technology
- 10in subwoofer
- 2 Ohm

PRODUCT CODE  
**80 48CWRT102**

**KICKER  
12IN 500W SUBWOOFER  
WITH DUAL 2-OHM VOICE COILS**

The only thing thin about the CompRT Subwoofer is the mounting depth. Whether its on the road, sand or trail, these tough subs work perfectly in nearly anything with a motor. The CompRT 10-Inch Subwoofer is an all-weather thin subwoofer with a pair of 2 Ohm voice coils.

- The CompRT 12-Inch Subwoofer is an all-weather thin mount subwoofer with a 2 Ohm dual voice coil design for superior wiring flexibility.
- The CompRT is designed for the sound quality audiophiles want, with the weatherproof performance powersports enthusiasts need. Only KICKER is truly able to deliver the best of both worlds.
- The CompRT 12-Inch Subwoofer works best with a sealed or ported enclosure and 500 watts of recommended power.

PRODUCT CODE  
**80 48CWRT122**



**KICKER  
10IN 500W 4-OHM  
MARINE SUBWOOFER**

The KICKER KM 10-inch Marine Subwoofer makes waves of its own in a sealed or ported enclosure. Made to take the power and the weather, this sub is custom made to bang in your boat. Packed with features and made specifically for marine use.

- 4-Ohm Voice Coil
- Injection-Molded Polypropylene Cone
- Co-molded Santoprene Surround
- UniPlate back plate and pole piece
- Thick tinsel leads
- Large ceramic magnet
- Rear gasketing included
- Polymer basket resists corrosion
- Stainless mounting hardware included

PRODUCT CODE  
**80 45KM102 2 OHM**  
**80 45KM104 4 OHM**



**KICKER  
KMG10 10IN (25CM) GRILLE  
FOR KM10 & KMF10 SUB**

Perfect for KM or KMF 10-inch or 12-inch Subwoofer, these LED-equipped grilles are molded from thick ABS plastic. Perfect for fresh and salt water, these waterproof grilles provide years of protection for your bass, while thick silicone-coated LEDs give your boat an added flair!

- Designed to fit 10in Kicker KM10 and KMF10 subwoofers.
- Single grille with built-in LED lights.
- Control lighting with the optional KMLC remote.

PRODUCT CODE  
**80 45KMG10C CHARCOAL**  
**80 45KMG10W WHITE**

**KICKER SUBWOOFERS**  
Kicker's subwoofers are synonymous with high-quality audio performance. With a history stretching back to 1973, their car subwoofers consistently provide maximum performance and bass to millions of vehicles.



**KICKER  
9IN 500W L7 QB8 SQUARE  
SUBWOOFER ENCLOSURE**

The L7 square subwoofer is chocked full of innovation, delivering extraordinary volume and detail in a tiny enclosure, barely 9in long. A custom made Reflex Subwoofer adds deeper, smoother bass without needing a larger box.

- The L7 square subwoofer is chocked full of innovation, delivering extraordinary volume and detail in a tiny enclosure, barely 9in long
- Armor clad box made of a quarter inch thick solid aluminum
- 2 Ohm Impedance, RMS: 500W

PRODUCT CODE  
**80 43L7QB82**



**KICKER  
SEALED THIN ENCLOSURE WITH  
2-OHM SQUARE SUBWOOFER**

Barely seven inches deep, the KICKER TL7T 10-Inch or 12-Inch Subwoofer Enclosure is perfect for big bass under or behind your seats. Covered in stylish black carpeting and built with thick MDF construction, these sturdy enclosures take some serious power, yet easily fit under your seat.

- Genuine KICKER L7T subwoofer included
- Angled Design for excellent fit
- Heavy internal bracing
- Single 2-Ohm terminal
- Easy to install and wire
- Thick black carpeting
- Rounded corners
- Embroidered KICKER logo
- Thick MDF construction

PRODUCT CODE  
**80 46TL7T102 10 INCH 500W**  
**80 46TL7T122 12 INCH 600W**



**KICKER  
8IN 600W SUBWOOFER  
TUBE ENCLOSURE**

Awesome bass-makers that pound! Ultra-deep and surprisingly loud, TB subs mount in your trunk or behind your truck's seat with equal ease. You get the bump you want without losing the space you need.

- Thick ABS tube construction
- Flexible horizontal or vertical mounting system
- Spring-Loaded speaker terminals
- CompR Woofer and Reflex Sub
- Ceramic magnet
- Advanced heat management system
- Signature double red stitching
- Grilles included

PRODUCT CODE  
**80 46CWTB82 2 OHM**  
**80 46CWTB84 4 OHM**



**KICKER  
12IN DUAL L7R 2-OHM  
SUBWOOFER ENCLOSURE**

The massive power handling of the dual L7R sub box only gets better with square subs! Get up to 20% more volume compared to a round driver, so you move more air and get more bass without the expense of a custom box.

- Genuine L7R subwoofer included
- Front-Facing port design for loudest possible bass
- Angled back for excellent fit
- Heavy internal bracing makes is last for years
- Single 2-Ohm terminal for quick installation
- Easy to install and wire
- Thick black carpeting to handle bumps and scrapes
- Aesthetically pleasing rounded corners
- Thick MDF construction

PRODUCT CODE  
**80 45DL7R122**



**KICKER  
12IN PORTED ENCLOSURE  
WITH MATCHING AMP & WIRING KIT**

Enjoy a great bass upgrade with this 12in sub in ported enclosure with matching amp and wiring kit. Connects to any aftermarket head units and most factory head units.

- 12-inch sub - 150 watts RMS 300 watts peak
- Amp - 125 watts RMS 250 watts peak

PRODUCT CODE  
**80 44KKP212**



**KICKER  
12IN 500W SUBWOOFER  
PORTED ENCLOSURE**

Blacked-out cone, powerful, reliable and LOUD! The CompR 12-Inch Subwoofer Enclosure is the easiest way to get legendary bass in your ride.

- Forced Air Cooling to help our subs run 25% cooler than before.
- Thick black carpeting gives the enclosure a sleek, refined look. The front-facing tuned port raises the bar for acoustic efficiency, creating incredible bass levels with minimal amplifier power.
- The CompR 12-Inch Subwoofer Enclosure works best with 500 watts of recommended power.

PRODUCT CODE  
**80 48VCWR122**



**KICKER  
6.75IN 150W  
SUBWOOFER ENCLOSURE**

CompRT subwoofer and a second passive sub behind the seat of a truck or in any vehicle that's low on space. The rugged sealed box was designed specifically for the subwoofer.

- CompRT 6-3/4in subwoofer.
- 3/4in MDF construction with carpet.
- 2-ohm total impedance.
- Power handling: 150 watts RMS (300 watts peak power).
- Frequency response: 35-500 Hz.
- Sensitivity: 82.6 dB.

PRODUCT CODE  
**80 48TCWRT672**



**KICKER  
8IN 300W 2-OHM  
DOWNWARD FIRING SUBWOOFER**

The CompRT Down-Firing Subwoofer Enclosure comes loaded with a passive reFLEX subwoofer and KICKER CompRT sub, then carpeted and loaded with a single 2 Ohm terminal. Covered in stylish black carpeting and built with thick MDF.

- CompRT Down-Firing 8-inch Subwoofer
- Get the bass you want. Keep the cargo space you need.
- The TRTP 12-inch Subwoofer Enclosure works best with 300 watts of recommended power.
- Loaded with a single 2 Ohm terminal.

PRODUCT CODE  
**80 48TRTP82**

**KICKER  
8IN 300W SUBWOOFER ENCLOSURE**

- Surprisingly strong, smooth bass in a box under 7 inches deep.
- Reflex Subwoofer and RT Sub.
- Works best with 300 watts of recommended power.
- 2 Ohm Impedance, peak: 600W, RMS: 300W.

PRODUCT CODE  
**80 48TCWRT82**

**KICKER  
10IN 400W SUBWOOFER ENCLOSURE**

- 10in CompRT subwoofer and passive radiator.
- 3/4in MDF construction with carpet.
- 2-ohm total impedance.
- Power handling: 125-400 watts RMS (800 watts peak power).
- Frequency response: 25-500 Hz.

PRODUCT CODE  
**80 48TCWRT102**

**KICKER  
12IN 500W SUBWOOFER ENCLOSURE**

- 12in CompRT Series Subwoofers.
- Injection-molded polypropylene cone.
- Santoprene surround.
- SoloKon technology.

PRODUCT CODE  
**80 48TCWRT122**



**KICKER  
8IN 150W COMPACT HIDEAWAY  
POWERED SUBWOOFER ENCLOSURE**

At just over 3in tall, the Hideaway will fit under many seats and in storage areas where you don't usually find powered subs. The powerful, built-in 150-watt RMS amplifier delivers strong bass that'll add depth and punch to any type of music.

- Remote bass control.
- High and low-level inputs for integration with nearly any factory or aftermarket head unit.

PRODUCT CODE  
**80 11HS8**



**KICKER  
10IN 180W COMPACT HIDEAWAY  
POWERED SUBWOOFER ENCLOSURE**

A compact powered 10-inch subwoofer that delivers surprising low frequency impact in a tough, all-aluminum frame, providing signature KICKER bass in a small enclosure.

- Accepting input signals ranging from 0.25 volt to 40 volts (400 watts at 4 Ohm) and fully compatible with newer vehicles using start/stop systems.
- Remote control allows you to change the amount of bass without changing the radio volume, for the perfect mixture of bass in your music at any volume.
- A mere 2mm taller than its little brother the HS8, the HS10 delivers more power.
- Quick-connect Molex® plug and harness includes power, signal and remote turn-on. It also features high- and low-level inputs for integration with nearly any factory or aftermarket head unit.

PRODUCT CODE  
**80 46HS10**



**KICKER QS SPEAKERS**

QS Component and Point Source speakers are more than just the best sounding drivers KICKER have ever made. They're a technical marvel. Using their signature Tri-Tech™ cone on the separates and Kevlar-impregnated Polypropylene on the coaxials, Teton® dome tweeters and metallized polypropylene capacitors, QS speakers deliver the sparkling highs and hyper-accurate midrange you need to feel like you're front row center!



**KICKER**  
**6.75IN 200W COMPONENT SPEAKER PAIR**

QS 6-3/4 Inch Separates are a matched component system, built for pure sonic reproduction. The QS Series crossovers allow you to use a single amplifier channel or use bi-amplification for even more flexibility and control. These QS separates work best with 100 watts of recommended power.

- QS speakers deliver the sparkling highs and hyper-accurate midrange you need to feel like you're front row center!
- The stunning midrange drivers, tonally precise tweeters and a superior crossover network come together to form an audiophile-quality component set perfect for demanding listeners.

PRODUCT CODE  
**80 41QSS674**



**KICKER**  
**6.75IN 200W 2-WAY COAXIAL CAR SPEAKER PAIR**

A Kevlar-impregnated polypropylene woofer cone steps up strength and clarity in the midrange and lower frequencies, while the Teton dome tweeter delivers all the high-frequency detail.

- 2-way 6-3/4 inch car speakers
- Kevlar-impregnated polypropylene woofer cone
- External crossover network with bi-amping capability and three-level tweeter attenuation
- Handles up to 100 watts RMS (200 watts peak power)
- Frequency range: 40-20,000 Hz
- Sensitivity: 86 dB
- Impedance: 4 ohms
- Grilles included

PRODUCT CODE  
**80 44QSC674**



**KICKER**  
**6.5IN 250W COMPONENT SPEAKER SYSTEM**

KICKER KS-Series Speakers let you play at concert-like volume, yet maintain the smoothness and subtlety to please even the most selective ear. Internally dampened polypropylene cones and durable rubber surrounds assist the woofers in creating precise midrange and bass, while high-quality silk-dome tweeters deliver natural, detailed highs.

- The KSS 6-1/2 Inch Separates are a matched component system, built for awesome sound
- High power handling with extended dynamic range
- Silk dome tweeters for a smooth sound
- Polypropylene woofer and tough rubber surrounds

PRODUCT CODE  
**80 47KSS6504**



**KICKER**  
**6X8IN 225W COMPONENT SPEAKER SYSTEM**

CS-Series 6x8 inch Component Speakers are the perfect factory upgrade when you have a separate woofer and tweeter. CS-Series components include separate titanium tweeters and two-way crossovers with tweeter level control to let you customize your sound for the best sonic quality.

- Fits nearly every car made
- 12dB crossovers with a smaller footprint for easier installation
- Three-position tweeter switch for dialing in your highs
- EVC (Extended Voice Coil) technology help deliver remarkable bass response
- Titanium tweeter construction and neodymium magnets to reveal subtle details
- UV-treated poly-foam surround assists with precise linear excursion
- Phase plugs in the woofer cones eliminate any distortion
- Steel mesh grilles protect your drivers
- Three tweeter mounting options including flush, angled and surface pods

PRODUCT CODE  
**80 46CSS684**



**KICKER**  
**6.5IN 300W COMPONENT SPEAKER SYSTEM**

Designed for easy installation in nearly any vehicle, CS-Series components include separate titanium tweeters and two-way crossovers with tweeter level control to let you customize your sound for the best sonic quality. The result is precise control with stunning musical realism.

- Fits nearly every car made
- 12dB crossovers with a smaller footprint for easier installation
- Three-position tweeter switch for dialing in your highs
- EVC (Extended Voice Coil) technology help deliver remarkable bass response
- Titanium tweeter construction and neodymium magnets to reveal subtle details
- UV-treated poly-foam surround assists with precise linear excursion
- Phase plugs in the woofer cones eliminate any distortion
- Steel mesh grilles protect your drivers
- Three tweeter mounting options including flush, angled and surface pods

PRODUCT CODE  
**80 46CSS654**

**KICKER**  
**6.75IN 300W COMPONENT SPEAKER SYSTEM**

The CS-Series 6-3/4 inch Component Speakers are built for awesome sound that plays as long as the ride takes you. The optimized footprint means great sound with hassle-free installation, no matter where you mount it!

- Fits nearly every car made
- 12dB crossovers with a smaller footprint for easier installation
- Three-position tweeter switch for dialing in your highs
- EVC (Extended Voice Coil) technology help deliver remarkable bass response
- Titanium tweeter construction and neodymium magnets to reveal subtle details
- UV-treated poly-foam surround assists with precise linear excursion
- Phase plugs in the woofer cones eliminate any distortion
- Steel mesh grilles protect your drivers
- Three tweeter mounting options including flush, angled and surface pods

PRODUCT CODE  
**80 46CSS674**

**KICKER KS SPEAKERS**

KICKER KS-Series Speakers let you play at concert-like volume, yet maintain the smoothness and subtlety to please even the most selective ear. The high-performance woofers utilize internally dampened polypropylene cones and tough rubber surrounds for outstanding midrange detail and pounding bass! All KS-Series woofers feature an ultra-slim mounting depth to easily fit in most factory speaker locations.



**KICKER**  
**11N (25MM ) 4-OHM TWEETER WITH SWIVEL MOUNT**

KS-Series one-inch Tweeters uses a silk dome to reproduce your music with incredible smoothness and accuracy. Comes complete with flush, angled and surface-pod mounting options and an in-line 12dB crossover. If you crave more volume and realism – you found the perfect option!

- Silk-dome tweeters for a smooth, natural sound
- Four tweeter mounting options (hardware included)
- Extended frequency response for ultimate listening
- Lightweight neodymium magnets provide efficient highs
- In-line 12dB crossover included.
- Poly-switch protection
- Grilles included

PRODUCT CODE  
**80 46KST2504**



**KICKER**  
**3.5IN 100W 2-WAY COAXIAL SPEAKERS PAIR**

- Upgrade your audio to new levels of accuracy with extended frequency response and the smoothest highs
- Play music at concert-like volume while maintaining smooth subtle sound with these (2) 3.5-inch coaxial speakers
- Work best with 15 to 50 watts of recommended (RMS) power
- Internally dampened polypropylene cones and durable rubber sounds deliver precise midrange and mid-bass tones while high-quality silk tweeter produce natural, detailed highs
- Fits in almost any vehicle with low profile design and thin mounting depth that easily fits behind factory grilles (grills not included)
- Sensitivity: 88 dB; Frequency range: 80-20,000 Hz; Top-mount depth: 1.62 inches; Impedance: 4 ohms; Silk dome tweeter: 0.5 inches

PRODUCT CODE  
**80 47KSC3504**

**KICKER**  
**4IN 150W 2-WAY COAXIAL SPEAKERS PAIR**

- Accurate sound, extended bass and smooth highs
- High power handling with extended dynamic range
- Silk dome tweeters for a smooth sound
- Polypropylene woofer and tough rubber surrounds
- 2-Way, Peak: 150W, RMS: 75W

PRODUCT CODE  
**80 47KSC404**



**KICKER**  
**5.25IN 150W 2-WAY COAXIAL SPEAKERS PAIR**

- High Power Handling
- Extended Dynamic Range
- Silk Dome Tweeters For A Smooth Sound
- Polypropylene Woofer And Tough Rubber Surrounds
- Thin-Mount Design Easily Fits Behind Factory Grilles
- Grilles Included

PRODUCT CODE  
**80 47KSC504**

**KICKER**  
**6.5IN 200W 2-WAY COAXIAL SPEAKERS PAIR**

- High Power Handling
- Extended Dynamic Range
- Silk Dome Tweeters For A Smooth Sound
- Polypropylene Woofer And Tough Rubber Surrounds
- Thin-Mount Design Easily Fits Behind Factory Grilles
- Grilles Included

PRODUCT CODE  
**80 47KSC6504**



**KICKER**  
**4X6IN 150W 2-WAY COAXIAL SPEAKERS PAIR**

- High Power Handling
- Extended Dynamic Range
- Silk Dome Tweeters For A Smooth Sound
- Polypropylene Woofer And Tough Rubber Surrounds
- Thin-Mount Design Easily Fits Behind Factory Grilles

PRODUCT CODE  
**80 47KSC4604**



**KICKER**  
**6 X 8IN 150W 2-WAY COAXIAL SPEAKERS PAIR**

- High Power Handling
- Extended Dynamic Range
- Silk Dome Tweeters For A Smooth Sound
- Polypropylene Woofer And Tough Rubber Surrounds
- Thin-Mount Design Easily Fits Behind Factory Grilles

PRODUCT CODE  
**80 47KSC6804**

**KICKER**  
**6X9IN 300W 2-WAY COAXIAL SPEAKERS PAIR**

- Accurate sound, extended bass and smooth highs
- High power handling with extended dynamic range
- Silk dome tweeters for a smooth sound
- Polypropylene woofer and tough rubber surrounds
- 2-Way, Peak: 300W, RMS: 150W

PRODUCT CODE  
**80 47KSC6904**

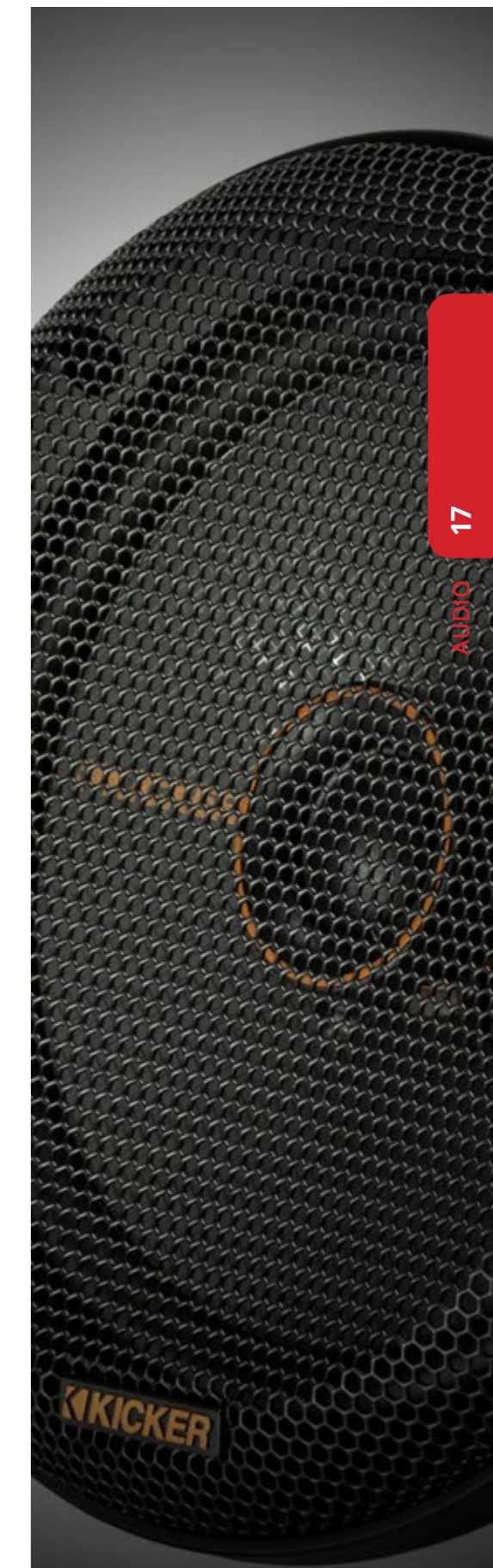

**KICKER CS SPEAKERS**

The CS-Series delivers remarkable performance and ultra-clean bass, utilizing a heavy-duty motor/magnet structure with EVC™ (Extended Voice Coil) for even deeper lows. Polypropylene cones and ribbed, UV-treated surrounds work together for excellent reliability and precise acoustic control.



**KICKER  
4IN 150W 2-WAY  
COAXIAL SPEAKERS PAIR**

The 4-Inch 2-way coaxial car speakers are great factory replacement speakers, providing rich, clear, and powerful sound. They work great on factory radio power or amplified power, and feature high quality build materials.

- The CS Series deliver remarkable performance and ultra-clean bass not found in stock speakers
- These speakers are an excellent factory upgrade
- Rigid polypropylene cone for excellent audio quality

PRODUCT CODE  
**80 46CSC44**



**KICKER  
6.5IN 300W 2-WAY  
COAXIAL SPEAKERS PAIR**

The 6.5-Inch 2-way coaxial car speakers are great factory replacement speakers, providing rich, clear, and powerful sound. They work great on factory radio power or amplified power, and feature high quality build materials.

- The CS Series deliver remarkable performance and ultra-clean bass not found in stock speakers
- These speakers are an excellent factory upgrade
- Rigid polypropylene cone for excellent audio quality

PRODUCT CODE  
**80 46CSC654**



**KICKER  
6 X 8IN 225W 2-WAY  
COAXIAL SPEAKERS PAIR**

CS-Series Coaxials deliver remarkable performance and ultra-clean bass with a heavy-duty motor/magnet structure not found in stock speakers. CS-Series 6x8-inch Coaxial Speakers are the perfect way to upgrade your factory system.

- Fits nearly every car made
- Zero-protrusion tweeters to fit nearly any factory depth
- Woofer EVC (Extended Voice Coil) tech assists with precise linear excursion
- UV-treated poly-foam surround resists heat or direct sunlight
- Large woofer magnet in a heavy-duty motor for ultra-clean bass
- PEI-tweeter construction provides superb clarity
- Neodymium tweeter magnets allow for increased volume in high frequencies

PRODUCT CODE  
**80 46CSC684**



**KICKER  
6 X 9IN 450W 3-WAY  
COAXIAL SPEAKERS PAIR**

The rugged 6x9-inch, 3-way speaker is especially cool. With a massive 300-watt peak power rating, this triaxial driver gives you extraordinary volume, while the integrated 2-inch midrange driver and dedicated tweeter give you crisp, accurate details for the realism you crave.

- Fits nearly every car made
- Zero-protrusion tweeters to fit nearly any factory depth
- Woofer EVC (Extended Voice Coil) tech assists with precise linear excursion
- UV-treated poly-foam surround resists heat or direct sunlight
- Large woofer magnet in a heavy-duty motor for ultra-clean bass
- Integrated 2-inch (50mm) midrange drivers gives detailed attention to mid frequencies
- PEI-tweeter construction provides superb clarity
- Neodymium tweeter magnets allow for increased volume in high frequencies
- Steel mesh grilles included for speaker protection

PRODUCT CODE  
**80 46CSC6934**



**KICKER  
5.25IN 225W 2-WAY  
COAXIAL SPEAKERS PAIR**

Kicker's low-protrusion tweeter, driven by a neodymium magnet, delivers your music's highs with control and clarity. Kicker's 5-1/4in 2-way speaker serves up stellar sound using a polypropylene woofer for the lower frequencies and a PEI balanced dome tweeter for the highs.

- Polypropylene woofer cone with polyester foam surround
- 1/2in polyetherimide (PEI) balanced dome tweeter
- Frequency response: 45-20,000 Hz
- Sensitivity: 90 dB
- Grilles included

PRODUCT CODE  
**80 46CSC54**



**KICKER  
4X6IN 150W 2-WAY COAXIAL  
CAR SPEAKER PAIR**

The CS Series delivers remarkable performance and ultra-clean bass, utilizing a heavy-duty motor/magnet structure featuring Extended Voice Coil technology not found in stock speakers. They use polypropylene cones with tough, ribbed, UV-treated surrounds for precise linear excursion and reliability.

- Fits nearly every car made
- Zero-protrusion tweeters to fit nearly any factory depth
- Woofer EVC (Extended Voice Coil) tech assists with precise linear excursion
- UV-treated poly-foam surround resists heat or direct sunlight
- Large woofer magnet in a heavy-duty motor for ultra-clean bass
- PEI-tweeter construction provides superb clarity
- Neodymium tweeter magnets allow for increased volume in high frequencies

PRODUCT CODE  
**80 46CSC464**

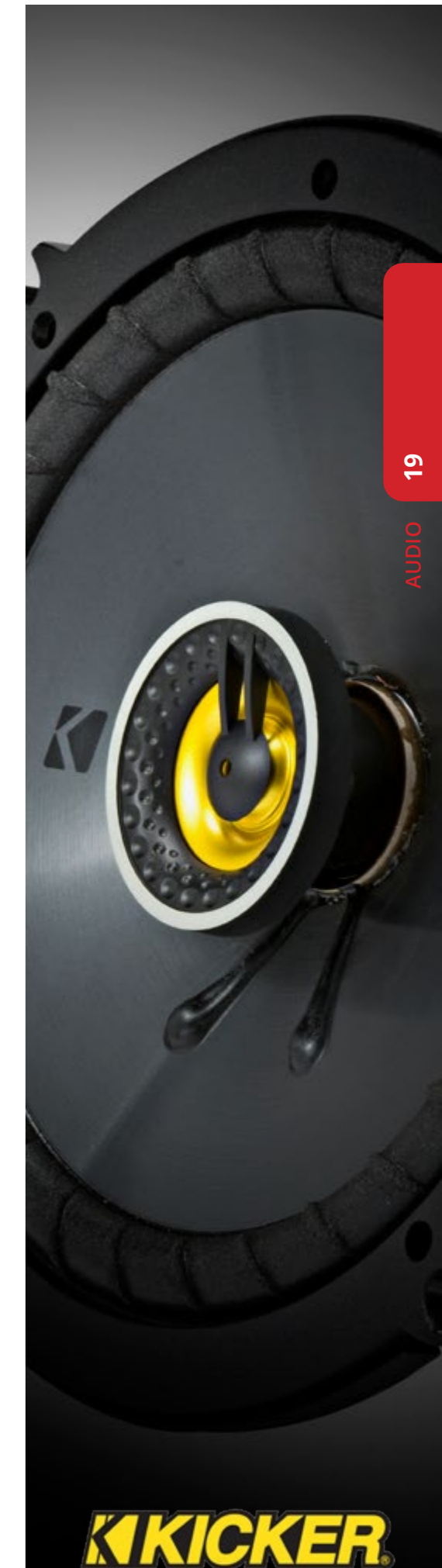

**KICKER MARINE SPEAKERS**

KICKER went the extra mile to make these coaxials 100% marine-grade. Built from the ground up to be the best possible speaker for your boat, they added UV treatments to injection-molded cones and Santoprene® surrounds. They made splash-and-spray-resistant sealed motors, cones and locking/sealed terminal covers. Even the grilles have a built-in drainage port to prevent standing water. It's all engineered to maintain top-shelf performance for years to come.



**KICKER 6.75IN HIGH EFFICIENCY MARINE COMPONENT SPEAKER SYSTEM**

The KMS67 Tower System is a horn-loaded, compression-driver (HLCD), high-efficiency component system providing maximum sound quality and especially at a distance. The system is weather-proof with sealed cones, motor assemblies and UV-treated components.

- The system is weather-proof with sealed cones
- Peak: 400W, RMS: 200W

PRODUCT CODE  
**80 41KMS674C**



**KICKER 6.75IN 300W MARINE TOWER LONG THROW SPEAKER SYSTEM**

The KMT67 Tower System is a full-range, high-quality two-way speaker system with dual weather-proof, injection-molded enclosures.

- Enclosures designed for either below- or above-the-bar mounting
- The system is weather-proof with sealed cones, motor assemblies and UV-treated components
- Dual midrange drivers (per enclosure) provide twice the cone area for big sound
- Billet-aluminum brackets and clamp inserts adjust to seven common sizes, matching most every wake tower or roll-bar diameter

PRODUCT CODE  
**80 41KMT674**

**KICKER LED LIGHTING REMOTE WITH RECEIVER MODULE**

Make your KICKER subs and speakers light up.

- 19 lighting modes and 20 colours to choose from
- Fade, brightness, speed/strobe and colour options

PRODUCT CODE  
**80 41KMLC**



**KICKER 6.5IN 195W COAXIAL MARINE SPEAKER PAIR**

Our speakers are made to thrive in the water. UV treatments on injection-molded cones, Santoprene surrounds, baskets and grilles all help maintain top-shelf performance. KM speakers will endure almost any weather conditions with splash-and-spray-resistant sealed motors, cones and locking/sealed terminal covers.

- 4-Ohm voice coil
- 3/4-Inch titanium tweeter
- UV-treated polypropylene woofer with santoprene surround
- UV-resistant polymer basket
- Locking/sealed terminal cover
- Sealed motor structure
- 316l stainless mounting hardware included
- Charcoal and white grilles included

PRODUCT CODE  
**80 45KM654**



**KICKER 6.5IN 195W COAXIAL LED MARINE SPEAKER PAIR**

These speakers are made to thrive in the water. UV treatments on injection-molded cones, Santoprene surrounds, baskets and grilles all help maintain top-shelf performance. KM speakers will endure almost any weather conditions with splash-and-spray-resistant sealed motors, cones and locking/sealed terminal covers.

- Spectacular full-range audio quality for your boat
- Multi-colour LED's can be changed to fit your mood
- Included with easy-to-match charcoal or white grilles
- Control LED colours with optional KMLC remote
- Peak: 195W, RMS: 65W

PRODUCT CODE  
**80 45KM654L**



**KICKER 6.5IN WHITE 150W COAXIAL MARINE SPEAKER PAIR**

These powerful 6-1/2in speakers are tough enough for marine duty, but easy on your ears. The durable poly woofers and 1/2in balanced dome tweeters cut through wind, waves, and engine roar to deliver great sound without annoying harshness.

- 2-way 6-1/2in marine speakers (pair)
- UV-treated polypropylene woofer with Santoprene rubber surround
- 1/2in PEI film dome tweeter with neodymium magnet
- White grilles
- Sealed motor structure and locking terminal covers
- Frequency response: 35-21,000 Hz
- Sensitivity: 90 dB

PRODUCT CODE  
**80 41KM604W**



**KICKER 6.5IN DUAL WEATHER PROOF EMPTY TOWER SPEAKER ENCLOSURES 2PK**

Mount 6-1/2-inch KICKER speakers for external listening in marine and powersport applications with weather-proof KM-Series Tower-Speaker Empty Enclosures.

- Designed with a nine-degree axis rotation in either direction, allowing the speaker cans to be aimed in the most desirable location to deliver maximum sound quality
- Includes polyfill, mounting hardware, aluminum tower-pipe clamps (2-5/8-inch)
- Three sizes of mounting adapters for the most popular pipe diameters (2-1/4, 2-3/8, 2-1/2)
- KICKER also offers the KMTAP Tower Enclosure Adapter Pack (sold separately) for fitting to several other pipe sizes

PRODUCT CODE  
**80 12KMTED**



**KICKER 6.5IN BLACK WEATHER PROOF EMPTY TOWER SPEAKER ENCLOSURE 2PK**

Mounting powerful 6-1/2-inch KICKER speakers for external listening in marine and powersport applications just got easier with KICKER's durable and weather-proof KM-Series Tower-Speaker Empty Enclosures.

- Two enclosures per carton
- Tough ABS, weather-proof empty enclosures with slotted mounting holes for different bolt patterns
- Nine-degree axis rotation in either direction for aiming maximum sound quality
- Fits Mounting Tube Sizes
- Satin nickel plated brass binding posts (screw to tighten style)

PRODUCT CODE  
**80 12KMTES**



**KICKER ADAPTER PACK FOR KMTES & KMTED TOWER ENCLOSURES**

The KMTAP Marine Enclosure Adapter Pack allows KICKER marine towers and empty enclosures to fit even more pipe sizes, assuring that we have the size you need! KMTAP is compatible with KMTES, KMTED and KMTES8 Speaker Enclosures.

- Black marine grade plastic
- Kit has the following adapter sizes: (4) 1 5/8in, (4) 1 3/4in, (4) 1 7/8in, (4) 2in

PRODUCT CODE  
**80 12KMTAP**



**KICKER  
4X50W 4-CHANNEL AUTO EQ  
PROCESSOR CAR AMPLIFIER**

Measuring less than eight inches long and only two inches high, KEY amps fit nearly anywhere. Mount them behind your radio, under the seat, or in your trunk with ease. KEY amplifiers are fully compatible with nearly every stock and aftermarket radio on the road today.

- The KEY200.4 is one of the first amps fully compatible with newer vehicles using start-stop systems
- In addition to an unbelievable sound quality, the KEY200.4 delivers 200 watts of pumpin' power to your factory speakers. At KICKER, we know power and clarity always go hand-in-hand
- If the temperature reaches the threshold, the KEY200.4's dynamic power-management algorithms kick into gear
- 200 Watts Of Power (50x4)
- Auto EQ microphone with selector switch included
- Auto speaker size detection

PRODUCT CODE  
**80 47KEY2004**



**KICKER  
500W COMPACT MONO AUTO EQ  
SUBWOOFER AMPLIFIER**

Measuring less than eight inches long and only two inches high, KEY amps fit nearly anywhere. Mount them behind your radio, under the seat, or in your trunk with ease. KEY amplifiers are fully compatible with nearly every stock and aftermarket radio on the road today.

- The KEY500.1 is a smart subwoofer amplifier and audio processor in one, featuring an AI-driven DSP (digital signal processing).
- The KEY automatically analyzes the audio being fed into the amplifier.
- Craft your sound with ease! The KEY500.1 comes with 24dB sub-sonic and low-pass crossovers, bass boost and gain controls.
- Measuring about eight inches long and less than two inches high, the KEY500.1 fits nearly anywhere. Mount it behind your glove box, under the seat, or in your trunk with ease.
- The amplifier also features FIT 2+ (Fail-safe Integration Technology 2 PLUS) which provides nearly universal compatibility with stock or aftermarket radios.
- The KEY amplifier will work with almost every car on the road today, whether you have a factory or aftermarket audio system.
- KEY500.1 will actually work with all KICKER subwoofers up to 12 inches.
- Another industry first, the KEY500.1 is uniquely suited to accept factory input signals as high as 40 volts (400 watts).

PRODUCT CODE  
**80 47KEY5001**



**KICKER  
1200W MONO  
SUBWOOFER AMPLIFIER**

Using a Class-D power plant, the CXA1200.1 features a variable bass boost with KickEQ, giving you as much as a 6dB of extra bump with a simple turn of the optional CXARC Remote Bass Controller.

- Efficient Class-D amplifier
- Three-second turn-on/off delay to eliminate unwanted interference
- Variable 12dB crossovers provides control to dial in perfect sound
- KickEQ 6dB variable bass boost for those additional low frequencies
- 24dB subsonic filter for protection from potentially damaging frequencies
- FIT+ (Fail-safe Integration Technology-PLUS) means it works with nearly every radio
- Accepts up to 40-volt input signal
- Small footprint for easier installation
- Compatible with CXARC Remote Bass Control

PRODUCT CODE  
**80 46CXA12001**

**KICKER  
1800W MONO  
SUBWOOFER AMPLIFIER**

CX-Series Amps reach massive power levels thanks to an optimized circuit layout and the highest-grade internal components. The CXA1800.1 Mono Amplifier is built for big bass in a sleek, yet affordable package giving you as much as a 6dB of extra bump.

- This CX-Series Amplifier delivers as much as 1,800 watts into one bass channel
- A powerful 12dB crossover and 24dB subsonic filter is included, letting you quickly tune your system to perfection
- Use the full range outputs to expand your system with other bass amps, or add a full range amp to complete your system
- Efficient Class-D amplifier
- Vertical mounting hardware included for another unique look
- Variable 12dB crossovers provides control to dial in perfect sound

PRODUCT CODE  
**80 46CXA18001**



**KICKER  
4X90W 4-CHANNEL  
FULL RANGE CAR AMPLIFIER**

Using Class A/B power, this amp features a variable bass boost with KickEQ, giving you as much as a 6dB of extra bump. CX-Series Amplifiers accept up to 40 volts (400 watts) of speaker-level input signal.

- Class A/B full-range channels
- Three-second turn-on/off delay to eliminate unwanted interference
- Variable 12dB crossovers provides control to dial in perfect sound
- KickEQ 6dB variable bass boost for those additional low frequencies
- FIT+ (Fail-safe Integration Technology-PLUS) means it works with nearly every radio
- Accepts up to 40-volt input signal
- Small footprint for easier installation
- Vertical mounting hardware included for another unique look
- Compatible with CXARC Remote Bass Control

PRODUCT CODE  
**80 46CXA3604**



**KICKER  
400W MONO SUBWOOFER AMPLIFIER**

CX-Series amps reach massive power levels thanks to an optimized circuit layout and the highest-grade internal components. Highly efficient heat sinks keep the amp cool with a sophisticated look. CX-Series Mono Amps are now one-ohm stable, giving you even more power and wiring options for your system!

- CX-Series Amplifiers are the perfect combination of big power, bigger flexibility and true reliability
- A variable 12dB crossover, KickEQ 6dB variable bass boost and a 24dB subsonic filter on mono amps gives you the control to craft the sound you love
- Mono KICKER CX Amplifiers are now stable down to one Ohm, giving you the freedom to put even more subs in your system
- CX-Series amps include vertical and horizontal mounting hardware, so you can show off your install style
- KICKER's CX-Series amplifier technology provides clean, powerful music in nearly any vehicle on the road today, without changing your radio or adding a line-out converter
- Three-second turn-on/off delay to eliminate unwanted interference
- Variable 12dB crossovers provides control to dial in perfect sound.
- 24dB subsonic filter for protection from potentially damaging frequencies

PRODUCT CODE  
**80 46CXA4001**

**KICKER  
800W MONO SUBWOOFER AMPLIFIER**

The CXA800.1 Mono Amplifier is built for affordable power and performance, thanks to optimized circuit layout and high-grade internal components.

- Built for big bass in a sleek, yet affordable amp
- KickEQ™ bass boost gives up to 6dB of extra bump
- Variable active crossover for system balancing
- Compact footprint expands mounting possibilities
- Delivers as much as 800 watts into one channel

PRODUCT CODE  
**80 46CXA8001**



**KICKER  
4 GAUGE 2-CHANNEL AMPLIFIER  
INSTALLATION WIRING KIT**

KICKER amp power kits feature top-quality Hyper-Flex power, ground and turn-on cables. A heavy-duty AFS fuse holder, fuse, terminals and zip ties come in the kit as well. This Four Gauge Amp Kit comes complete with Full Spec wire, hardware and fusing.

- Kit includes: 17ft 4 awg blue power wire, 4ft 4 awg gray ground wire, Self tapping bolt and washer, FHS fuse holder with 100 amp fuse L=3.06in, W=1.33in, H=1.32in.
- Kit Includes: 17ft 16 gauge remote wire, 6x 6in zip ties, 4 awg firewall grommet and 1x 18-22 awg butt connector.

PRODUCT CODE  
**80 46PK4**



**KICKER  
DASH MOUNT WIRED  
REMOTE BASS CONTROLLER**

CX-Series mono amps offer an optional remote level control to adjust your bass right from the dash. Dial it up the way you want to hear it. Customize your bass, right from your front seat.

- Cable Length - 19.75 feet.
- Bass Remote Controller.
- Compatible with the KEY500.1 and any CX, DX or PX KICKER amplifier.
- Surface Mount installation.
- Screws included.

PRODUCT CODE  
**80 46CXARC**

**KICKER AMPLIFIERS**

Kicker amplifiers provide amazing power, control, and flexibility, accompanied by a sleek design.



**KICKER  
600W MONO MARINE AMPLIFIER**

Use this flexible KM marine subwoofer amplifier to power your bass with ease. Experience the perfect way to get bass on your boat! Use the remote level control to adjust the bass right from the dash and connect the full-range RCA outputs to expand your system!

- Class-D Power Supply
- Mono Amplifier
- Conformal-Coated Circuit Board
- Remote Level Control Included
- Variable 12dB Crossover
- KickEQ Variable 12dB Bass Boost
- 24dB Subsonic Filter
- 316L Stainless-Steel Hardware Included

PRODUCT CODE  
**80 45KMA6001**

**KICKER  
800W MONO MARINE AMPLIFIER**

Purpose-built for your boat, every KM amp comes complete with marine-grade speaker terminals, stainless-steel screws, conformal-coated circuit boards and ABYC/NMMA-compliant power connections. Dialing in your sound is easy with KM amps - the amplifiers are also equipped with the KickEQ™ variable 12dB bass boost!

- Purpose-built for your boat, every KM amp comes complete with marine-grade speaker terminals, stainless-steel screws, conformal-coated circuit boards and ABYC/NMMA-compliant power connections.
- Dialing in your sound is easy with KMA amps. Variable 12dB crossovers are built in, plus a 24dB subsonic filter is also included on the KMA800.1 mono amplifier, and Amp 3 of the KMA600.6.
- This six-channel, 600-watt amp provides an easy way to get the perfect volume levels on (or off) the deck, in the water, or inside the cabin.

PRODUCT CODE  
**80 48KMA8001**



**KICKER  
4X90W 4-CHANNEL FULL RANGE  
MARINE AMPLIFIER**

Purpose-built for your boat, every KM amp comes complete with marine-grade speaker terminals, stainless-steel screws, conformal-coated circuit boards and ABYC/NMMA-compliant power connections. Dialing in your sound is easy with KM amps - the amplifiers are also equipped with the KickEQ™ variable 12dB bass boost!

- Purpose-built for your boat, every KM amp comes complete with marine-grade speaker terminals, stainless-steel screws, conformal-coated circuit boards and ABYC/NMMA-compliant power connections.
- Dialing in your sound is easy with KMA amps. Variable 12dB crossovers are built in, plus a 24dB subsonic filter is also included on the KMA800.1 mono amplifier, and Amp 3 of the KMA600.6.
- This six-channel, 600-watt amp provides an easy way to get the perfect volume levels on (or off) the deck, in the water, or inside the cabin.

PRODUCT CODE  
**80 48KMA3604**

**KICKER  
6X100W 6 CHANNEL FULL RANGE  
MARINE AMPLIFIER**

Purpose-built for your boat, every KM amp comes complete with marine-grade speaker terminals, stainless-steel screws, conformal-coated circuit boards and ABYC/NMMA-compliant power connections. Dialing in your sound is easy with KM amps - the amplifiers are also equipped with the KickEQ™ variable 12dB bass boost!

- Purpose-built for your boat, every KM amp comes complete with marine-grade speaker terminals, stainless-steel screws, conformal-coated circuit boards and ABYC/NMMA-compliant power connections.
- Dialing in your sound is easy with KMA amps. Variable 12dB crossovers are built in, plus a 24dB subsonic filter is also included on the KMA800.1 mono amplifier, and Amp 3 of the KMA600.6.
- This six-channel, 600-watt amp provides an easy way to get the perfect volume levels on (or off) the deck, in the water, or inside the cabin.

PRODUCT CODE  
**80 48KMA6006**



**KICKER  
300W RMS 4-CHANNEL  
MARINE AMPLIFIER**

Use this flexible four-channel KM marine amplifier to power your system with ease and pump up the sound like only KICKER can! Using a Class-D power plant, this amp features a variable bass boost with KickEQ, giving you as much as 12dB of extra bump.

- Class-D Power Supply
- Four-Channel Amplifier With Bridging Capability
- Conformal-Coated Circuit Board
- Variable 12dB Crossover
- KickEQ Variable 12dB Bass Boost
- ABYC/NMMA-Compliant Power Connections
- 316L Stainless-Steel Hardware Included

PRODUCT CODE  
**80 45KMA3004**



**KICKER  
450W RMS 6 CHANNEL  
MARINE AMPLIFIER**

Use this flexible KM six-Channel Marine Amplifier to power your system with ease and pump up the sound like only KICKER can! With this KM Six-Channel Amp, your boat is a floating concert!

- Class-D Power Supply
- Six-Channel Amplifier With Bridging Capability
- Three-Zone Control
- Full-Range Volume Controller Included
- Conformal-Coated Circuit Board
- Variable 12dB Crossover
- 24dB Subsonic Filter (Amp 3 Only)
- KickEQ Variable 12dB Bass Boost
- 316L Stainless-Steel Hardware Included

PRODUCT CODE  
**80 45KMA4506**



**KICKER  
MARINE COMPACT  
DIGITAL MEDIA RECEIVER**

Equipped with an easily readable screen, rotary encoder and over 200 watts of total peak power into four channels, the KMC3 comes equipped with plenty of power. Add even more bump to your boat by adding amplifiers to the included RCA outputs.

- Fits in gauge opening.
- Uses USB, RCA, AM/FM and Bluetooth audio sources.
- USB audio playback or charging.
- RCA outputs.
- IP67 certification.
- Bluetooth Range: 30 feet.

PRODUCT CODE  
**80 46KMC3**



**KICKER  
3IN 100W ENCLOSED  
MOUNTABLE SPEAKER POD PAIR**

Enhance the tunes on vehicles with handlebars but no fairing with PSM3 Mini-Enclosed Speakers. The PSM Mini 40 Enclosed Speakers are built for excellent sound on your ATV or motorcycle handlebars. These weatherproof speakers come in durable chromed enclosures, complete with handlebar mounting hardware.

- Built for excellent sound on your ATV or motorcycle handlebars.
- Weatherproof speakers in durable chromed enclosures.
- Complete with handlebar mounting hardware.
- Peak: 100W, RMS: 50W.

PRODUCT CODE  
**80 47PSM34**



**KICKER  
MARINE DUAL ZONE  
DIGITAL MEDIA RECEIVER**

The KMC4 features four channels and up to 200 watts of built-in power. It comes equipped with an AM/FM/weather-band tuner, charging USB connection and four sets of RCA outputs for easy expansion. The KMC4 is ready for any music you want to play.

- Charging USB w/Thumb-Drive Playback
- Bluetooth Connectivity
- Full-Colour LCD Display
- 3" Hole Cutout
- KRC12 Remote Compatible
- AM/FM and Weather-Band Tuner
- Up to 10 Favorites for each source: AM and FM
- Front and Rear RCA Outputs, Plus Subwoofer and Zone 2
- AUX RCA Input

PRODUCT CODE  
**80 46KMC4**



**KICKER  
2X50W FULL RANGE STEREO  
AMPLIFIED CONTROLLER WITH  
BLUETOOTH**

The PXiBT100.2 Stereo Amplified Controller With Bluetooth is the only solution you need for sound in your ride. No radio necessary. Whether it's a motorcycle, side-by-sides, ATV or even a classic car, this weatherproof amp delivers the power you need, on or off the road.

- Stereo amplified controller with Bluetooth is the only solution you need for sound in your ride
- No radio necessary
- Illuminated display to change track, volume & source
- Delivers as much as 100 total watts into two channels

PRODUCT CODE  
**80 42PXIBT1002**



**KICKER  
MARINE PREMIUM  
DIGITAL MEDIA RECEIVER**

Tons more fun for your cruise! KICKER's premier KMC5 Media Center features six channels of built-in power, delivering up to 240 watts to your speakers! Equipped with an AM/FM/satellite/weather-band tuner, charging USB connection and four sets of RCA outputs for easy expansion.

- Charging USB w/Thumb-Drive Playback
- Bluetooth Connectivity
- Full-Colour LCD Display
- SiriusXM ready
- 3" Hole Cutout
- Dedicated Zone 2 speaker outputs
- NMEA Port
- Video RCA Input with Remote trigger wire
- AM/FM and Weather-band Tuner

PRODUCT CODE  
**80 46KMC5**



**KICKER  
6.5IN 2-WAY INDOOR/OUTDOOR  
SPEAKER PAIR**

The KB6 is a full-range, high-efficiency speaker system truly suitable for indoor and outdoor use. Providing an 8-Ohm load and ready to be driven by your home stereo receiver or a car-audio amplifier, you can easily run a single pair or more with minimal effort.

- Play the KB6 on your backyard deck, under the eaves, inside the shop, or near the pool for great sound, rain or shine.
- Use the universal bracket to mount the KB6 on your boat, off-road vehicle or RV.

PRODUCT CODE  
**80 46KB6B BLACK**  
**80 46KB6G GREY**



**CLARION SINGLE DIN CD MP3 RECEIVER WITH USB & AUX INCAR**

The CZ207AU single din audio receiver has a sleek and sharp edgy design. It is packed full of features including: AM/FM tuner, CD/MP3/WMA playback and USB/SD/AUX inputs. The sound quality is superb with a built in 45w x 4 amplifier and beat EQ sound customisation.

- CD/MP3/WMA playback.
- Single line high visibility LCD.
- Front USB for audio playback.
- SD card slot for MP3/WMA music playback.
- Front 3.5mm AUX input with sensitivity adjustment.
- Wireless infrared remote control included.
- OEM steering wheel remote ready.
- Subwoofer level control.

PRODUCT CODE  
**81 CZ207AU**



**CLARION SINGLE DIN CD MP3 RECEIVER WITH BLUETOOTH & USB**

The CZ307AU single din audio receiver has a sleek and sharp edgy design. It is packed full of features including built in Bluetooth for hands-free calls and wireless audio streaming, AM/FM tuner, CD/MP3/WMA playback, USB/SD/AUX inputs, the CZ307AU has it all.

- CD/MP3/WMA playback.
- Single line high visibility LCD.
- Front USB for audio playback.
- SD card slot for MP3/WMA music playback.
- Front 3.5mm AUX input with sensitivity adjustment.
- Wireless infrared remote control included.
- OEM steering wheel remote ready.

PRODUCT CODE  
**81 CZ307AU**



**CLARION SINGLE DIN USB AUX-IN SD MP3 AUTO RECEIVER WITH WMA BLUETOOTH**

The FZ307AU single din mechless audio receiver has a sleek and sharp edgy design. It is packed full of features including built in Bluetooth for hands-free calls and wireless audio streaming, AM/FM tuner, MP3/WMA playback, USB/SD/AUX inputs, the FZ307AU has it all.

- Short-body, mechless design.
- Built-in Bluetooth for hands-free communication and wireless audio streaming.
- Single line high visibility LCD.
- Easy to operate, rotary volume control.
- Front USB for audio playback.
- Front 3.5mm AUX input with sensitivity adjustment.
- OEM steering wheel remote ready.

PRODUCT CODE  
**81 FZ307AU**



**CLARION 6.75IN HD TOUCH SCREEN WITH APPLE CARPLAY/ANDROID AUTO**

The FX688A has a connected, intuitive display audio for visual and sound presence. Enjoy a variety of media with displayed audio, including USB and AUX connections, not to mention Bluetooth audio streaming.

- Apple CarPlay compatibility
- Also compatible with Android Auto
- Smart Device Link (SDL) is the industry standard for open source in-vehicle connectivity. SDL broadens the choices for customers in how they connect and control their smartphones while on the move
- Miracast Connecting your smartphone to FX688A wirelessly and link the phone display and video to a larger display without a direct wired connection
- Rear USB for even more connectivity
- AUX Input for various external sources
- Rear vision camera support for safety and security
- 13 band Parametric equaliser

PRODUCT CODE  
**81 FX688A**



**CLARION INFRARED HEADPHONES COMPATIBLE WITH CLARION VT1020A**

The IR700 premium wireless headphones are designed to be used with the Clarion Roof Top Monitor and other monitors that use infrared audio. The headphones are designed to isolate system audio from road and cabin noise, resulting in high quality audio and longer battery life.

- Infrared wireless headphones.
- Noise-isolating construction.
- Single channel operation.
- Long battery life.
- Batteries included.

PRODUCT CODE  
**81 IR700**



**CLARION 10.1IN HD ROOFTOP MONITOR WITH MOTORIZED SCREEN**

The VT1020A 10.1in high definition roof top monitor is sleek and low profile that mounts discreetly to the vehicles roof. The motorised screen will automatically lower and raise with a tap of a button on the remote control.

- 10.1in high definition display.
- Active Matrix System provides edge to edge clear, crisp images.
- High-efficiency LED backlight technology produces consistent brightness across the display for superb viewing experience in HD.
- Motorised display monitor, open and close with a touch of a button on the remote.
- Dual HDMI, single USB and single composite video inputs.
- Wireless infrared remote control included.

PRODUCT CODE  
**81 VT1020A**



**CLARION 6IN & 6.5IN 300W 2-WAY COAXIAL SPEAKERS**

The SE1625R 6-6.5in 300W 2-way coaxial speakers are part of the SE Series range of speakers from Clarion. Clarion's SE Series enables you to enjoy powerful, dynamic sound with stable performance over a broad range from highs to lows, all in coaxial and multi-axial speakers design.

- 6-6.5" (160mm) size, suitable for 6" and 6.5" installations.
- 2-way coaxial speakers.
- 300 watts maximum power handling.
- Powerful strontium magnet for dynamic bass response.
- 41mm mounting depth.
- Grilles included.

PRODUCT CODE  
**81 SE1625R**



**CLARION 6X9IN 400W 3-WAY COAXIAL SPEAKER PAIR**

The SE6934R 6x9in 400W 3-way multi-axial speakers are part of the SE Series range of speakers that enables you to enjoy powerful, dynamic sound with stable performance over a broad range from highs to lows, all in coaxial and multi-axial speakers design.

- 400 watts maximum power handling.
- 150 x 230 mm MIPP cone woofer.
- Powerful strontium magnet for dynamic bass response.
- Grille included.

PRODUCT CODE  
**81 SE6934R**



**CLARION 6IN & 6.5IN 400W 2-WAY COMPONENT SPEAKER SYSTEM**

The SH1624S 6-6 1/2in 400W 2-way component speakers are part of the SH Series range of speakers that produce dynamic performance over a broader frequency range, from thundering lows to sizzling highs.

- 400 watts maximum power handling.
- 160mm cone woofer.
- 20mm pure soft dome tweeter with neodymium magnet.
- Phase plug.
- 2-way mounting tweeter (flush or surface mounting).
- Powerful strontium magnet for dynamic bass response.
- Grille and mesh included.

PRODUCT CODE  
**81 SH1624S**



**CLARION 6IN & 6.5IN 370W 3-WAY MULTI-AXIAL SPEAKER PAIR**

The SH1634R 6-6 1/2in 370W 3-way multi-axial speakers are part of the SH Series range of speakers that produce dynamic performance over a broader frequency range, from thundering lows to sizzling highs.

- 370 watts maximum power handling.
- 160mm MIPP cone woofer.
- 20mm pure soft dome midrange with neodymium magnet.
- 8mm pure soft dome tweeter.
- Powerful strontium magnet for dynamic bass response.
- Grille and mesh included.

PRODUCT CODE  
**81 SH1634R**



**CLARION 1 CHANNEL 400W MICRO SIZE MONO AMPLIFIER**

The XC2110 is a micro sized amplifier that is so compact it can be mounted virtually anywhere, even behind most dashboards. This 1 channel amp delivers 300W RMS to a subwoofer. The amplifier is built to produce high sound quality and withstand the toughest environments.

- 400 Watts of maximum power output.
- 1 channel.
- 200 Watts \_ 1 continuous @ 4-Ohms and 300 Watts \_ 1 continuous @ 2-Ohms.
- Corrosion resistant nickel plated RCA, power, and speaker connections.
- RCA and high level speaker inputs.

PRODUCT CODE  
**81 XC2110**



**CLARION 4-CHANNEL 400W MICRO SIZE AMPLIFIER**

The XC2410 is a micro sized amplifier that is so compact it can be mounted virtually anywhere, even behind most dashboards. This 4 channel amp delivers 50W RMS per channel to the front and rear speakers.

- 400 Watts of maximum power output.
- Up to 4 channels.
- 50 Watts \_ 4 continuous @ 4-Ohms, 75 Watts \_ 4 continuous @ 2-Ohms & 150 Watts \_ 2 continuous @ 4-ohms bridged.
- Corrosion resistant nickel plated RCA, power, and speaker connections.
- RCA and high level speaker inputs.
- Double sided conformal coated PCB assembly.

PRODUCT CODE  
**81 XC2410**

AUDIO 26

AUDIO 27



**HERTZ  
MARINE DIGITAL MEDIA RECEIVER**

HMR10, is ideal for boat enthusiasts who want great sound on board with a reduced gauge installation. With two pairs of high quality stereo outputs, a screen readable at all times and a generous marine-grade control panel, it will be a breeze to control your favorite playlist.

- Hertz Pure Marine Certified Product stamp featuring the IP66 protection grade, ASTM-D4329 standards for UV resistance and ASTM-B117 for salt fog operation.
- PLL True Marine Radio with multi-format reception FM/AM/WB and automatic memory storage.
- Wide range of media playbacks including Bluetooth streaming and control, USB playback and analogue AUX IN.
- Equaliser featuring 3 presets (CLASSIC/ POP/ ROCK).
- Loudness control.
- Fits in gauge opening.

PRODUCT CODE  
**83 HMR10**



**HERTZ  
3IN MARINE DISPLAY  
DIGITAL MEDIA RECEIVER**

HMR20 Marine Digital Media Receiver features IP66 protection, designed to withstand the most extreme marine conditions. The Large full colour TDT IPS display remains visible both day and night and the variable colour buttons allow the radio to match the lights in the boat console.

- The large full colour TFT IPS display remains visible even during daytime navigation and the big buttons make it easy operating while cruising.
- Multicolour button light for a perfect match with boat console lights.
- Customise the sound with 4 EQ preset created by Hertz audio engineers.
- Voltage indicator to check-up battery status.
- AM/FM with RDS (where available).

PRODUCT CODE  
**83 HMR20**



**HERTZ  
SINGLE 12IN SEALED SUB BOX**

The DBX 30.3 car audio subwoofer box is designed to enhance the audio system performance in the low range frequencies, optimizing the spaces and ensuring a quick, not too invasive installation.

- Very high efficiency subwoofer system with superior power handling.
- Very thick MDF cabinet construction, strong and inert.
- Angled rear wall, increases damping of resonances and provides easy fitment.
- High current plated terminal.

PRODUCT CODE  
**83 DBX303**



**HERTZ  
8IN SUBWOOFER 600W PEAK**

The Ultra Flat profile reaches 85mm height for the ESF20.5 subwoofer, 94mm height for the ESF25.5 subwoofer and 106mm for the ESF25.5 subwoofer ensuring high mechanical quality as well as efficient thermal capability, to the benefit of bursting dynamics and startling power handling.

- The energy ES F20.5 car audio subwoofers is the ideal solution for those who look for a subwoofer of compact size, yet providing powerful and engaging sound.
- Ultra Flat design, for maximum installation flexibility.
- Massive motor assembly, for perfect control under high power, high excursion conditions.
- Water-repellent pressed paper cone.
- Copper voice coil, wound on aluminium former, for startling thermal and mechanical capacity.

PRODUCT CODE  
**83 ESF205**



**HERTZ  
CENTO 6.5IN 285W 2-WAY  
SPEAKER SYSTEM WITH GRILLE SET**

Cento CK165 two-way speaker system includes the new C26 tweeter featuring a 26mm (1in) Tetolon dome and 20mm (0.8in) voice coil for a detailed and natural reproduction of medium-high frequencies.

- 165 mm (6.5in) semi-pressed paper cone SPP-M (Semi Pressed PaperMica) enhanced with Mica powder for an excellent balance between lightness and damping.
- High-density flux ferrite magnet combined with low-carbon polar plates for reduced distortion at high power levels.
- 25 mm (1in) voice coil featuring an aluminum former to guarantee high excursion and power handling.
- Compact and transparent three-spoke basket acoustically combined with a rubber magnet cover for total damping of spurious vibrations.
- Optional elegant grille made with high-resistance ABS plastic structure with a metallic finish combined with a protective metal mesh.

PRODUCT CODE  
**83 CK165**



**HERTZ  
CENTO 4IN 120W 2-WAY  
COAXIAL SYSTEM**

The Cento two-way coaxials CX100 features the new 24mm Tetolon dome tweeter that delivers a more musical and detailed sound compared to the more traditional plastic materials.

- Soft Tetolon fiber 24mm dome tweeter cooled with ferrofluid, for extended and natural high frequencies.
- Rotary High Frequency Contour tweeter angled and directable to the listener for a perfect frequency response in any installation scenario.
- Tweeter faceplate geometry optimised with FEM simulations, to provide an extremely linear frequency response in off-axis installations.
- 4.25mm woofer voice coil featuring an aluminum former to guarantee high excursion and power handling.
- 100mm semi-pressed paper cone SPP-M (Semi Pressed Paper-Mica) enhanced with Mica powder for an excellent balance between lightness and damping.
- High-density flux ferrite magnet combined with low-carbon polar plates for reduced distortion at high power levels.
- Compact and transparent three-spoke basket acoustically combined with a rubber magnet cover for total damping of spurious vibrations.
- Optional elegant grille made with high-resistance ABS plastic structure with a metallic finish combined with a protective metal mesh.

PRODUCT CODE  
**83 CX100**



**HERTZ  
CENTO 2-WAY COAXIAL SYSTEM  
210W 6.5IN**

The Cento two-way coaxials CX165 features the new 24mm Tetolon dome tweeter that delivers a more musical and detailed sound compared to ones made from traditional plastic materials.

- Soft Tetolon fiber 24mm dome tweeter cooled with ferrofluid, for extended and natural high frequencies.
- Rotary High Frequency Contour tweeter angled and directable to the listener for a perfect frequency response in any installation scenario.
- Tweeter faceplate geometry optimised with FEM simulations (Finite Element Modeling), to provide an extremely linear frequency response in off-axis installations.
- 25mm woofer voice coil featuring an aluminum former to guarantee high excursion and power handling.
- 165mm semi-pressed paper cone SPP-M (Semi Pressed Paper-Mica) enhanced with Mica powder for an excellent balance between lightness and damping.
- High-density flux ferrite magnet combined with low-carbon polar plates for reduced distortion at high power levels.
- Compact and transparent three-spoke basket acoustically combined with a rubber magnet cover for total damping of spurious vibrations.
- Optional elegant grille made with high-resistance ABS plastic structure with a metallic finish combined with a protective metal mesh.

PRODUCT CODE  
**83 CX165**



**HERTZ  
10IN SUBWOOFER 600W PEAK**

The DS 25.3 car audio subwoofers offer high efficiency and exceptional power handling. Equipped with a polypropylene membrane and butyl rubber surround, they provide high excursion with minimal distortion. An efficient cooling system ensures optimal heat dissipation, increasing their reliability.

- Polypropylene membrane stiffened with mineral powder.
- High excursion butyl rubber surround.
- Deep ribbing on the surface of the cone increase rigidity.
- Very high efficiency, with superior power handling.

PRODUCT CODE  
**83 DS253**



**HERTZ  
12IN SUBWOOFER 1000W PEAK**

The DS 30.3 car audio subwoofers offer high efficiency and exceptional power handling. Equipped with a polypropylene membrane and butyl rubber surround, they provide high excursion with minimal distortion. An efficient cooling system ensures optimal heat dissipation, increasing their reliability.

- Polypropylene membrane stiffened with mineral powder.
- High excursion butyl rubber surround.
- Deep ribbing on the surface of the cone increase rigidity.
- Very high efficiency, with superior power handling.

PRODUCT CODE  
**83 DS303**





**HERTZ  
4IN 2-WAY COAXIAL SPEAKERS**

The DCX 100.3 car audio coaxials is designed with maniacal care to provide a linear frequency response and ensure high reliability. A Neodymium magnet, PEI dome tweeter, built-in crossover, TPU surround and a pressed-paper cone provide the optimum ratio between installation friendliness and sound. High sensitivity level allows the speakers to be powered off any source unit including oem headunit.

- Perfect sound upgrade for vehicles with factory 4in speakers.
- 60W peak power (30W continuous) produces powerful sound in any vehicle.
- High sensitivity level allows the speakers to be powered off any source unit including oem headunit, aftermarket.

PRODUCT CODE  
**83 DCX1003**

**HERTZ  
5IN 2-WAY COAXIAL SPEAKERS 80W**

- Perfect sound upgrade for vehicles with factory 5in speakers.
- 80W peak power (40W continuous) produces powerful sound in any vehicle

PRODUCT CODE  
**83 DCX1303**



**HERTZ  
SET 6X9IN 3-WAY SPEAKERS + GRILLES**

The DCX 690.3 car audio coaxials uses an oversized magnetic group, TPU (Thermoplastic polyurethane) surround, a 60 mm diameter midrange and a PEI dome tweeter. The result is linearity, wide dispersion and extra-ordinary efficiency not found in traditional coax components.

- Perfect sound upgrade for vehicles with factory 6.5 x 9in speakers.
- 180W peak power (90W continuous) produces powerful sound in any vehicle.

PRODUCT CODE  
**83 DCX6903**



**HERTZ  
DIECI 6IN 120W 2-WAY  
COAXIAL SPEAKER PAIR**

The Dieci coaxes were designed with maniacal care to provide a linear frequency response and ensure high reliability. A Neodymium magnet, PEI dome tweeter, built-in crossover, TPU surround and a pressed-paper cone provide the optimum ratio between installation friendliness and sound.

- Large motor assembly for mobile voice coil control.
- Pure copper voice coil, wound on conex former, for maximum lightness.
- Water-repellent treated paper cone.
- TPU surround, for wide excursion and resonance damping.
- Neodymium tweeter with PEI dome, for compactness and energy at high frequencies.
- DIN size basket protected by abrasion-proof dust paint.
- Tin-plated, high current terminals.
- Silver-plated lead wires for maximum reliability and conductivity.
- Butyl rubber protective cover, against crashes and abrasions.

PRODUCT CODE  
**83 DCX160.3**



**HERTZ  
6X4IN 2-WAY COAXIAL SPEAKERS  
80W 40WRMS**

- Two way coaxial design low profile tweeter mount.
- Large motor assembly for mobile voice coil control.
- Pure copper voice coil, wound on conex former, for maximum lightness.
- Water-repellent treated paper cone.
- TPU surround, for wide excursion and resonance damping.
- Neodymium tweeter with PEI dome, for compactness and energy at high frequencies.
- Tin-plated, high current terminals.
- Low carbon content plates for maximum magnetic permeability and high heat dissipation.

PRODUCT CODE  
**83 DCX4603**



**HERTZ  
DIECI 6IN 160W 2-WAY  
SPEAKER SYSTEM SET**

Includes an adapter ring designed for installation in GM and Honda models with OEM speakers and a cable with built-in crossover for the DT 24.3 tweeter, designed to save space in a OEM upgrade scenario.

- 24 mm PEI dome-cone tweeter has a high efficiency annular acoustic lens and a high energy neodymium magnet.
- Woofer has a large motor assembly for mobile voice coil control, pure copper voice coil, wound on conex former, for maximum lightness, tin-plated, high current terminals and Silver-plated lead wires for maximum reliability and conductivity.

PRODUCT CODE  
**83 DSK160.3**



**HERTZ  
6.5IN 100W 2-WAY BLACK  
COAXIAL MARINE SPEAKER PAIR**

HEX65MC marine coaxial, also available in white grille, will give you years of pure fun while cruising, being over engineered and tested for Marine applications. The compact 6.5-inch speaker, with a depth of only 2.36 inches delivers a detailed and dynamic sound, making every outing memorable.

- Hertz Pure Marine Certified Product stamp featuring the IP65 protection.
- High efficiency tweeter designed with FEM simulation to maximise off-axis emission, typical of in-boat install.
- Sound-transparent mesh grille with twist and lock locking system, providing an elegant style and a rock-solid protection.
- Woofer with 25mm (1-inch) voice coil fine-tuned for infinite baffle application featuring silicone insulated lead-wire for durability.
- Sealed built-in crossover with resettable solid-state tweeter protection circuit.
- Nickel-plated corrosion resistant terminals.

PRODUCT CODE  
**83 HEX6.5MC BLACK**  
**83 HEX6.5MW WHITE**



**HERTZ  
6.5IN 2-WAY SYSTEM 300W**

The Hertz MLK 1650.3 Legend car audio speakers system is a two way kit dedicated to purists, aiming at achieving maximum timbre consistency combined with very high dynamics and extremely extended frequency response.

- Die-cast aluminium factory provided grille featuring diamond-cut aluminium Hertz logo.
- V-Cone and Boundary Free Surround technology.

PRODUCT CODE  
**83 MLK16503**



**HERTZ  
2-WAY SPEAKER SYSTEM 220W PEAK**

The MPK 165.3 car audio speakers system has been designed to ensure a wide low frequency response, even in cars with no space for a subwoofer. The MPCX2.3 crossover features tweeter level (0/+2 dB) to calibrate the MP25.3 acoustic emission level comparing it to the woofer one.

- Provided full protection metal mesh grill featuring the aluminium Hertz logo and attractive look mineral powder coated inner grill are included for several install combinations.
- V-Cone and Boundary Free Surround technology.

PRODUCT CODE  
**83 MPK1653**



**HERTZ  
6.5IN 2-WAY SPEAKER SYSTEM**

The MPK 165P.3 car audio speakers system energy in the mid-low range ensures a unique listening experience, creating the ideal set up alongside a powerful subwoofer section. Forged to give it the pure and solid sound of an authentic mid-bass, designed for high dynamic systems.

- Provided full protection metal mesh grill featuring the aluminium Hertz logo and attractive look mineral powder coated inner grill are included for several install combinations.

PRODUCT CODE  
**83 MPK165P3**



**HERTZ  
6.5IN 2-WAY COAXIAL SPEAKER SET**

The coax tweeter concentric to the woofer allows for one single linear-phase emission point, for a natural timbre providing a detailed sound stage.

- Concentric coaxial tweeter: built in the woofer voice coil, one single point of emission to re-create the virtual sound-stage like in live music performances. Tweeter support working as a rear chamber: sized for low Fs, well damped high pass frequency roll-off, allowing low cut-off frequency crossover point.
- 36 mm pure copper woofer voice coil: wound on a Polyamide former, for outstanding power handling and dynamic compression-free reproduction.
- Pressed-pulp cone with cotton fibers: combining stiffness and lightweight for a wide frequency response.
- Boundary free rubber surround: for improved efficiency and wider midbass.
- Over-sized ferrite magnet: combined with very low carbon content iron plates, for low distortion at high power levels.
- Anti-vibration rubber magnet cover: to damp spurious vibrations.

PRODUCT CODE  
**83 MPX1653**



**HERTZ  
4 X 105W + 1 X 330W MARINE  
5-CHANNEL AMPLIFIER**

HCP5MD, a marine 5 channel amplifier is engineered and tested for real environment of application (UV, salt-fog, vibrations, high/low temperature, thermal shock, dust) and has a large array of filters customized for each model, to achieve maximum versatility.

- Nature proof.
- Completed filter section.

PRODUCT CODE  
**83 HCP5MD**



**AUDISON  
6.5IN WOOFER 210W 4-OHM**

AP6.5 feature a 32mm pure copper voice coil, for high power handling and outstanding low frequency control. The dome profile has been optimised with Klippel R&D Scan Vibrometer to obtain a calibrated mechanical low-pass cut-off frequency.

- 32mm pure copper mobile voice coil, for high power handling and outstanding low frequency control.
- Water repellent treated paper cone, featuring a profile developed with FEM (Finite Element Method) simulation technology and optimized with the Klippel R&D Scan Vibrometer.
- No passive crossover required to maximize efficiency: the cone is optimised with the Klippel R&D Scan Vibrometer to obtain a calibrated mechanical low-pass cut-off frequency.
- Reduced mounting depth, providing ease of installation in OEM placements.
- TPU (Thermoplastic Polyurethane) surround, featuring the exclusive shallow "Triple Wave" profile, for maximum excursion linearity.
- Compact basket, protected by abrasion resistant and scratch-proof coating, the motor affixed with damping epoxy adhesive.
- High current fast-on terminal with double contact on positive and negative poles for high flexibility and quick connection.
- Developed with the KLIPPEL suite.
- Grilles optional.

PRODUCT CODE  
**82 AP65**



**AUDISON  
PRIMA LINE APBX 10AS2  
ACTIVE SUBWOOFER**

The Prima APBX 10 AS2 active subwoofer, with 10 - inch driver, features a dedicated high performance amplification module which enhances all the passive box technologies, such as the 2 Sides/2 Sounds design, the Plug & Play terminal block and ultra - compact size.

- D - Class amplifier featuring he - li technology (high efficiency / low impedance) without switching power supply, for a performance next to ideal.
- Input stage DBT (Dynamic Bass Tracking) technology allows 100% use of the he - li amplifier power and to enjoy a tense and dynamic bass even at very high listening volumes.
- Defeatable filter to use the sub dedicated output of a bit or AP bit processor.
- High level audio input on multi - pin connector for maximum OEM integration and low level on RCA for aftermarket sources.
- ART turn on function (Automatic Remote Turn - On).
- Box with ultra - low profile (6.22 in./ 158 mm) in air suspension, designed to take full advantage of the performance of the 10 - inch APS 10 DL high - impedance driver.
- The SSP (Sub Smart Plug) terminal block is provided with a Plug & Play connector to be able to disconnect the box easily and safely.
- Down - firing levelling feet with Velcro inserts included for a secure grip with the carpet, ensuring extreme ease of removal.

PRODUCT CODE  
**82 APBX10A2**



**AUDISON  
10IN SEALED SUBWOOFER BOX**

The APBX 10 DS, a 10in subwoofer loaded in a 12 litre sealed enclosure, is the line's "flagship". It is dedicated to the highest performing Prima systems, using the AP1 D amplifier for the sub section.

- Ultra low profile (5.6 in. / 142 mm) box with sealed design perfectly tuned to fully exploit the APS 10 D driver.
- 2S2 (2 Sides/2 Sounds) design provides the ability to choose between down-firing mounting to increase the low - frequency extension and Up-Firing install to obtain more punch and definition.
- Levelling feet with velcro inserts included for a secure grip with the carpet while maintaining easy removal.
- SSP (Sub Smart Plug) features both traditional push contacts and a Plug-&-Play terminal block to easily configure the impedance as required and provides a quick release.
- Rounded corners allow easy positioning in the trunk and act as reinforcement to reduce enclosure resonance.
- Special designed cone-dust cap-basket geometry which guarantees a long linear excursion capability (11 mm, one - way).
- Massive driver motor assembly, optimized with FEM (Finite Element Modelling) for perfect control under high excursion conditions.
- Water-repellent pressed paper 10in cone, featuring a profile developed with FEM simulation and optimized with the Klippel Scan Vibrometer.
- Sturdy metal grid included for a total protection of the subwoofer driver

PRODUCT CODE  
**82 APBX10DS**



**AUDISON  
8IN SEALED SUBWOOFER BOX**

The APBX 8 DS loaded enclosure provides the highest performance to size ratio. For this purpose an 8.5lt. sealed enclosure with a 4+4 ohm dual voice coil configuration was adopted to exploit the full power of an AP5.9 bit or with two pairs of AP8.9.

- Ultra-low profile (5.16in. / 131mm) box with sealed design perfectly tuned to fully exploit the APS 8 D driver.
- 2S2 (2 Sides/2 Sounds) design provides the ability to choose between Down-Firing mounting to increase the low-frequency extension and Up-Firing install to obtain more punch and definition.
- Levelling feet with velcro inserts included for a secure grip with the carpet while maintaining easy removal.
- SSP (Sub Smart Plug) features both traditional push contacts and a Plug-&-Play terminal block to easily configure the impedance as required and provides a quick release.
- Rounded corners allow easy positioning in the trunk and act as reinforcement to reduce enclosure resonance.
- Special designed cone-dust cap-basket geometry which guarantees a long linear excursion capability (9mm, one-way).
- Massive driver motor assembly, optimized with FEM (Finite Element Modelling) for perfect control under high excursion conditions.
- Water-repellent pressed paper 8in. cone, featuring a profile developed with FEM simulation and optimized with the Klippel Scan Vibrometer.
- Sturdy metal grid included for a total protection of the subwoofer driver.

PRODUCT CODE  
**82 APBX8DS**



**AUDISON  
8IN REFLEX SUBWOOFER BOX**

The APBX8R loaded enclosure was developed with reflex loading, with tuning designed to concentrate SPL in the lowest frequency range. The aim was to exploit the natural boost in output found in most cars below 60 Hz known as "cabin gain".

- Ultra-low profile (5.16in. / 131mm) box with slot-ported design perfectly tuned to fully exploit the APS 8 R driver.
- 2S2 (2 Sides/2 Sounds) design provides the ability to choose between Down-Firing mounting to increase the low-frequency extension and Up-Firing install to obtain more punch and definition.
- Levelling feet with velcro inserts included for a secure grip with the carpet while maintaining easy removal.
- SSP (Sub Smart Plug) features both traditional push contacts and a Plug-&-Play terminal block to easily configure the impedance as required and provides a quick release.
- Rounded corners allow easy positioning in the trunk and act as reinforcement to reduce enclosure resonance.
- Special designed cone-dust cap-basket geometry which guarantees a long linear excursion capability (9mm, one-way).
- Massive driver motor assembly, optimized with FEM (Finite Element Modelling) for perfect control under high excursion conditions.
- Water-repellent pressed paper 8in. cone, featuring a profile developed with FEM and optimized with the Klippel Scan Vibrometer.
- Sturdy metal grid included for a total protection of the subwoofer driver.

PRODUCT CODE  
**82 APBX8R**



**AUDISON  
10IN 800W DUAL COIL SUBWOOFER  
4+4-OHM**

The APS 10 D is designed to deliver maximum performance in a sealed enclosure with ultra - compact volumes, from 10 lt. to 12 lt. The dual voice coil and single voice coil versions feature push connectors for ease of wiring and configurations.

- Ultra low profile (4.7in / 120mm) for maximum installation flexibility.
- Designed to deliver maximum performance in a sealed enclosure starting from 10lt.
- Special designed cone, dust cap, basket geometry which guarantees a long linear excursion capability (11mm, one way) while keeping the mounting depth to minimum.
- Air vents on the basket underneath the spider, eliminating the need for the central pole vent allowing mounting close to rear wall of enclosure.
- Massive motor assembly, optimized with FEM (Finite Element Modelling) for perfect control under high power, high excursion conditions.
- Water repellent pressed paper 10in. cone, featuring a profile developed with FEM simulation and optimized with the Klippel Scan Vibrometer.
- Dual voice coil design specifically developed to be combined with either AP8.9bit (2 CH + 2 CH bridged), APF8.9bit (1CH + 1CH).
- Steel mesh grille and plastic gasket included.

PRODUCT CODE  
**82 APS10D**



**AUDISON  
PRIMA LINE  
APS 10 S4S  
SUBWOOFER**

The APS10S4S is designed to deliver maximum performance in a sealed enclosure with ultra - compact volumes, from 10 lt. to 12 lt. The dual voice - coil and single voice coil versions feature push connectors for ease of wiring and configurations.

- Ultra - low profile (4.7 in/ 120mm) for maximum installation flexibility.
- Designed to deliver maximum performance in a sealed enclosure starting from 10 lt.
- Special designed cone - dust cap - basket geometry which guarantees a long linear excursion capability (11mm, one - way) while keeping the mounting depth to minimum.
- Air vents on the basket underneath the spider, eliminating the need for the central pole vent allowing mounting close to rear wall of enclosure.
- Massive motor assembly, optimized with FEM (Finite Element Modelling) for perfect control under high power, high excursion conditions.
- Water - repellent pressed paper 10 in. cone, featuring a profile developed with FEM simulation and optimized with the Klippel Scan Vibrometer.
- Steel mesh grille and plastic gasket included

PRODUCT CODE  
**82 APS10S4S**



**AUDISON  
8IN 500W  
DUAL COIL SUBWOOFER  
4+4-OHM**

The APS8D is designed to deliver maximum performance in a sealed enclosure with ultra - compact volumes from 7.5lt to 8.5lt. It features push connectors for ease of wiring and configurations.

- Ultra low profile (3.11in / 79mm) for maximum installation flexibility.
- Designed to deliver maximum performance in a sealed enclosure starting from 7.5lt.
- Special designed cone, dust cap, basket geometry which guarantees a long linear excursion capability (almost 9mm, one way) while keeping the mounting depth to minimum.
- Air vents on the basket underneath the spider, eliminating the need for the central pole vent allowing mounting close to rear wall of enclosure.
- Massive motor assembly optimized with FEM (Finite Element Modelling) for perfect control under high power, high excursion conditions.
- Water repellent pressed paper 8in. cone featuring a profile developed with simulation and optimized with the Klippel Scan Vibrometer.
- Dual voice coil design.
- Steel mesh grille, hardware and plastic gasket included.

PRODUCT CODE  
**82 APS8D**



**AUDISON  
8IN 500W  
SINGLE COIL SUBWOOFER  
4-OHM**

With the aim of providing high acoustical output even when used with lower power, the APS8R was designed for use in an 8.5 litres reflex enclosure, with tuning between 30 and 40Hz.

- Ultra - low profile (3.11in. / 79mm) for maximum installation flexibility.
- Designed to deliver maximum performance in a sealed enclosure starting from 7.5 lt.
- Special designed cone - dust cap - basket geometry which guarantees a long linear excursion capability (almost 9mm, one - way) while keeping the mounting depth to minimum.
- Air vents on the basket underneath the spider, eliminating the need for the central pole vent allowing mounting close to rear wall of enclosure.
- Massive motor assembly optimized with FEM (Finite Element Modelling) for perfect control under high power, high excursion conditions.
- Water - repellent pressed paper 8 in. cone featuring a profile developed with simulation and optimized with the Klippel Scan Vibrometer.
- Single 4 ohm voice coil design.
- Steel mesh grille, hardware and plastic gasket included.

PRODUCT CODE  
**82 APS8R**



**AUDISON  
4IN 40W  
MIDBASS COMPONENT SPEAKER**

The AP4 midbass offers very extended frequency response, both in high and low frequencies, combined with high efficiency and features a 25mm pure copper voice coil to ensure more balance in mid - high frequency ranges.

- Very extended frequency response, in both high and low frequencies, combined with high efficiency.
- No passive crossover required to maximize efficiency.
- Water-repellent treated paper cone, featuring a profile developed with FEM (Finite Element Method) simulation technology and optimized with the Klippel R&D Scan Vibrometer.
- Reduced mounting depth, providing ease of installation in OEM placements.
- TPU (Thermoplastic Polyurethane) surround, featuring the exclusive shallow "Triple Wave" profile for maximum excursion linearity.
- 25mm pure copper voice coil ensuring precise balance in the mid - high frequency range.
- Compact basket, protected by abrasion resistant and scratch proof coating.

PRODUCT CODE  
**82 ELAP4**



**AUDISON  
5IN 50W  
COMPONENT WOOFER**

AP5 feature a 32mm pure copper voice coil, for high power handling and outstanding low frequency control. The woofers don't employ any filter, to maximize efficiency.

- 32mm pure copper mobile voice coil, for high power handling and outstanding low frequency control.
- No passive crossover required to maximize efficiency: the cone is optimised with the Klippel R&D Scan Vibrometer to obtain a calibrated mechanical low pass cut-off frequency.
- Reduced mounting depth, providing ease of installation in OEM placements.
- TPU (Thermoplastic Polyurethane) surround, featuring the exclusive shallow "Triple Wave" profile, for maximum excursion linearity.
- Compact basket, protected by abrasion resistant and scratch-proof coating, the motor affixed with damping epoxy adhesive.
- High current fast-on terminal with double contact on positive and negative poles for high flexibility and quick connection.

PRODUCT CODE  
**82 ELAP5**



**AUDISON  
8IN 100W  
COMPONENT WOOFER**

For the vehicles equipped with an 8inch woofer as standard OEM component, the AP8 provides higher energy in the low frequency range, ensuring excellent performance when the use of a subwoofer is prohibited due to space limitations.

- Water repellent treated paper cone, featuring a profile developed with FEM (Finite Element Method) simulation technology and optimized with the Klippel Scan Vibrometer.
- No passive crossover required to maximize efficiency.
- Reduced mounting depth, providing ease of installation in OEM placements.
- TPU (Thermoplastic Polyurethane) surround, featuring the exclusive shallow "Triple Wave" profile, for maximum excursion linearity.
- Compact basket, protected by abrasion resistant and scratch-proof coating, the motor affixed with damping epoxy adhesive.
- High current fast - on terminal with double contact on positive and negative poles for high flexibility and quick connection.

PRODUCT CODE  
**82 ELAP8**



**AUDISON**  
**SET 4IN 2-WAY COAX SPEAKERS**

APX4 features a concentric coaxial tweeter: with one single point of sound emission it is possible to obtain a consistent in - phase response, with consequent reconstruction of the acoustic scene comparable to a system of separate woofer + tweeter.

- Tweeter is mounted within the woofer with one single point of emission providing consistent phase response, with an accurate recreation of the sound stage comparable to that of a component system.
- Tweeter features an acoustic lens specifically designed to ensure an extremely linear frequency response, even in off - axis placement, typical of in - door installations.
- 32mm pure copper voice coil, for high power handling and outstanding low frequency control.
- Overall mounting depth optimized for OEM Integration thanks to the concentric tweeter and the low profile basket.
- Water-repellent treated paper cone, featuring a profile developed with FEM (Finite Element Method) simulation technology and optimized with the Klippel Scan Vibrometer.
- TPU (Thermoplastic Polyurethane) surround, featuring the exclusive shallow "Triple Wave" profile, for maximum excursion linearity.
- Compact basket, protected by abrasion - resistant and scratch - proof coating, the motor affixed with damping epoxy adhesive.
- High current fast - on terminal with double contact on positive and negative poles for high flexibility and quick connection.

PRODUCT CODE  
**82 APX4**



**AUDISON**  
**SET 5IN 2-WAY COAX SPEAKERS**

APX5 features a concentric coaxial tweeter: with one single point of sound emission it is possible to obtain a consistent in - phase response, with consequent reconstruction of the acoustic scene comparable to a system of separate woofer + tweeter.

- Tweeter is mounted within the woofer with one single point of emission providing consistent phase response, with an accurate recreation of the sound stage comparable to that of a component system.
- Tweeter features an acoustic lens specifically designed to ensure an extremely linear frequency response, even in off - axis placement, typical of in - door installations.
- 32mm pure copper voice coil, for high power handling and outstanding low frequency control.
- Overall mounting depth optimized for OEM Integration thanks to the concentric tweeter and the low profile basket.
- Water-repellent treated paper cone, featuring a profile developed with FEM (Finite Element Method) simulation technology and optimized with the Klippel Scan Vibrometer.
- TPU (Thermoplastic Polyurethane) surround, featuring the exclusive shallow "Triple Wave" profile, for maximum excursion linearity.
- Compact basket, protected by abrasion - resistant and scratch - proof coating, the motor affixed with damping epoxy adhesive.
- High current fast - on terminal with double contact on positive and negative poles for high flexibility and quick connection.

PRODUCT CODE  
**82 APX5**



**AUDISON**  
**SET 6.5IN 2-WAY COAX SPEAKERS**

APX 6.5 features a concentric coaxial tweeter: with one single point of sound emission it is possible to obtain a consistent in - phase response, with consequent reconstruction of the acoustic scene comparable to a system of separate woofer + tweeter.

- Concentric Coaxial Tweeter: tweeter is mounted within the woofer with one single point of emission providing consistent phase response.
- Tweeter features an acoustic lens specifically designed to ensure an extremely linear frequency response, even in off - axis placement, typical of in - door installations.
- 32 mm pure copper voice coil, for high power handling and outstanding low frequency control.
- Overall mounting depth optimized for OEM Integration thanks to the concentric tweeter and the low profile basket.
- Water - repellent treated paper cone, featuring a profile developed with FEM (Finite Element Method) simulation technology and optimized with the Klippel Scan Vibrometer.
- TPU (Thermoplastic Polyurethane) surround, featuring the exclusive shallow INTriple WaveIN profile, for maximum excursion linearity.
- Compact basket, protected by abrasion - resistant and scratch - proof coating, the motor affixed with damping epoxy adhesive.
- High current fast - on terminal with double contact on positive and negative poles for high flexibility and quick connection.

PRODUCT CODE  
**82 APX6.5**



**AUDISON**  
**6.5IN 125W 2-WAY COMPONENT SYSTEM**

The prestigious Eisa Award European In - Car Speaker System 2010 - 2011 was bestowed to the AV K6 kit, which gather and comprise the most advanced technologies developed for the Audison components, at the service of music. The whole R&D laboratory's experience was poured into the design of these precious components, to create a synergy that can offer the highest quality sound in terms of bandwidth, dynamics of the musical message, naturalness and richness of details. The new reference for their own category.

- Tetolon dome, a combination of silk and cotton with proprietary damping treatment, provides low mass and resonance - free response up to ultrasonic frequencies.
- CCAW (Copper Clad Aluminium Wire) voice coil wound on double layer, extremely lightweight and compact, resulting in a very high efficiency and a crisp, dynamic sound.
- The annular geometry of the Rear Damping Chamber, together with the proprietary damping material, extends the frequency response to lower limits and reduces harmonic distortion.
- High flux density Neodymium REN magnet, for very high efficiency and detailed sound.
- The profile of the aerodynamic basket is spokes along with the open - air design ensure drastic reduction of back - wave reflections.
- The exclusive Butyl rubber "Triple Wave" surround profile provides full linearity as well as reliable performance under extreme conditions.
- Cotton - fibre pressed paper cone with Light Damping treatment.
- The Radial Venting System ensures high thermal capability, power handling and reliability.

PRODUCT CODE  
**82 AVK6**



**AUDISON**  
**26MM TWEETER + CROSSOVER**

The AP1 tweeter features a 26mm diameter emission diaphragm, an acoustic lens designed to compensate for the frequency response within the 10kHz-13kHz range, a Neodymium REN magnet and extremely small sized dedicated passive crossover.

- 26mm diameter diaphragm combined with a wide - roll surround provides maximum efficiency and reduced resonance frequency.
- Neodymium magnet with low carbon content plates, provides reduced size and more linear sound reproduction, even during the most demanding audio passages.
- Acoustic lens designed to compensate for and fine tune the in - car frequency response anomalies in the 10kHz - 13kHz bandwidth caused by restrictive OEM grilles in critical OEM placements.
- Compact dedicated passive crossover APCX TW supplied with the product, featuring an attenuation switch (0 dB, +2 dB) to tune the in car response according to different installation conditions.
- Passive crossovers are supplied with "OEM Integration compliant" fast-on connectors. The ends, different in each of the two poles, eliminate any possible connection errors at installation time.
- Wide array of mounting accessories supplied with the product, for high fitment flexibility in OEM Integration.
- CCAW (Copper Clad Aluminium Wire) ultra - light ferrofluid cooled voice coil is wound on a Kapton former, for better heat dissipation.
- Dome profile and motor are optimised with FEM (Finite Element Method) simulation technology.
- Developed with the KLIPPEL suite.

PRODUCT CODE  
**82 AP1**



**AUDISON**  
**SPEAKER GRILLES**

The APG4 & APG5 PRIMA speaker grille features a two piece design, offering the user a high strength full mesh face. The unique embossing in the mesh provides a prestigious look and feel.

- Full mesh design.
- Hardware included.

PRODUCT CODE  
**82 APG4 4 INCH**  
**82 APG5 5 INCH**



**AUDISON**  
**5IN 2-WAY COMPONENT SYSTEM 225W 4-OHM**

Two way system features AP 1 tweeter and AP 5 woofer. APCX TW crossover features a two-position level selector providing the ability to adapt its response to its two main applications: +2dB if installed behind the OEM grille, 0dB for an A-pillar installation without additional grilles.

- AP1 tweeter with 26mm diameter diaphragm combined with a wide-roll surround provides maximum efficiency and reduced resonance frequency.
- AP1 tweeter with acoustic lens designed to compensate for and fine tune the in-car frequency response anomalies in the 10kHz-13kHz bandwidth caused by restrictive OEM grilles.
- APCX TW very compact tweeter passive crossover optimized for OEM Integration featuring an attenuation switch (0 dB, +2dB) to tune the in-car response according to different installation conditions.
- Passive crossovers are supplied with "OEM Integration compliant" fast-on connectors. The ends, different in each of the two poles, eliminate any possible connection errors at installation time.
- AP5 woofer with 32mm pure copper voice coil, for high power handling and outstanding low frequency control.
- AP5 woofer with water-repellent treated paper cone, featuring a profile developed with FEM (Finite Element Method) simulation technology and optimized with the Klippel R&D Scan Vibrometer.
- AP5 woofer with reduced mounting depth, providing ease of installation in OEM placements.
- AP5 woofer with TPU (Thermoplastic Polyurethane) surround, featuring the exclusive shallow "Triple Wave" profile, for maximum excursion linearity.
- AP5 woofer with compact basket, protected by abrasion-resistant and scratch-proof coating, the motor affixed with damping epoxy adhesive.

PRODUCT CODE  
**82 APK130**



**AUDISON**  
**6.5IN 2-WAY COMPONENT SYSTEM 300W 4-OHM**

Two way system features AP 1 tweeter and AP 6.5 woofer. APCX TW crossover features a two-position level selector providing the ability to adapt its response to its two main applications: +2dB if installed behind the OEM grille, 0dB for an A-pillar installation without additional grilles.

- AP 1 tweeter with 26mm diameter diaphragm combined with a wide-roll surround provides maximum efficiency and reduced resonance frequency.
- AP 1 tweeter with acoustic lens designed to compensate for and fine tune the in-car frequency response anomalies in the 10kHz-13kHz bandwidth caused by restrictive OEM grilles.
- APCX TW very compact tweeter passive crossover optimised for OEM Integration featuring an attenuation switch (0dB, +2dB) to tune the in-car response according to different installation conditions.
- Passive crossovers are supplied with "OEM Integration compliant" fast-on connectors. The ends, different in each of the two poles, eliminate any possible connection errors at installation time.
- AP 6.5 woofer with 32 mm pure copper voice coil, for high power handling and outstanding low frequency control.
- AP 6.5 woofer with water-repellent treated paper cone, featuring a profile developed with FEM (Finite Element Method) simulation technology and optimized with the Klippel R&D Scan Vibrometer.
- AP 6.5 woofer with reduced mounting depth, providing ease of installation in OEM placements.
- AP 6.5 woofer with TPU (Thermoplastic Polyurethane) surround, featuring the exclusive shallow "Triple Wave" profile, for maximum excursion linearity.
- AP 6.5 woofer with compact basket, protected by abrasion-resistant and scratch-proof coating, the motor affixed with damping epoxy adhesive.

PRODUCT CODE  
**82 APK165**



**AUDISON**  
**6.5IN 2-WAY COMPONENT SYSTEM 300W 2-OHM**

APK 165 2ohm system features 2 crossovers dedicated to woofer and tweeter and separated, to ease the installation.

- 2ohm impedance, to fully exploit the 65W power per channel at 2ohm of the AP8.9 bit amplifier.
- 75Hz resonance frequency, to extend the frequency range down to low frequencies up to 50 Hz and increase the SPL in the low range.
- 25mm mobile voice coil to maximize efficiency achieving 95dB.
- APCX WF 2 ohm dedicated woofer crossover with low-loss voice coils to shape the frequency response for optimal match with the tweeter.
- AP1 tweeter with acoustic lens designed to balance the frequency response in the 10kHz-13kHz range to optimize the products acoustic emission where it is affected by the presence of the factory grille
- AP 6.5 2ohm woofer featuring water-repellent treated paper cone, with profile developed with FEM simulation technology and optimized with Klippel Scan Vibrometer.
- Woofer with reduced mounting depth, providing ease of installation in OEM placements.
- Woofer with TPU (Thermoplastic Polyurethane) surround, featuring the exclusive "Triple Wave" shallow profile, for maximum excursion linearity.
- Woofer with compact basket, protected by abrasion-resistant and scratch-proof coating. Damping epoxy glue provides perfect coupling with the motor system.

PRODUCT CODE  
**82 APK16520**



**AUDISON**  
**6.5IN 2-WAY COMPONENT SYSTEM 345W 4-OHM**

The new Prima APK 165P two - way loudspeaker system, capable of handling up to 345W peak, is the ideal combination to fully exploit the power of the APF8.9 bit or all other Prima amplifiers used in high power configurations.

- AP 1P AIF technology (Any Install Faceplate) for total application versatility and a significant reduction in installation time.
- Three mounting accessories supplied to provide a solution for any type of installation.
- Magnetic group with double Neodymium tablet for an excellent high frequency extension.
- 1IN CCAW voice coil for superior dynamic response.
- Dome profile optimized with FEM simulations for a wide off - axis dispersion.
- AP 6.5P Increased excursion of the mobile group for a superior dynamic response.
- Optimized electro - acoustic parameters to maximize performance for OEM placements.
- Magnetic group sized for perfect control even at maximum cone excursion.
- CCAW (Copper - Clad Aluminium Wire) voice coil (32 x 14 mm) to optimally manage the greater applied power.

PRODUCT CODE  
**82 APK165P**



**AUDISON**  
**75W X 4 SR 4.300 4-CHANNEL**  
**D-CLASS AMPLIFIER**

The Audison SR 4.300 Amplifier is for the SR Line of Audison, featuring high power amplifiers with a compact design. The amplifier is 2 ohm stable, has a compact design and extruded aluminium chassis with rounded corners, makes it easy to install in narrow spaces.

- ADC (Audison D-Class) Technology 21<sup>o</sup> stable output stage ensuring high audio performance in a compact size.
- Extruded aluminium compact design with fan less convection cooling system.
- Built-in USS (Universal Speakers Simulator).
- Balanced high-noise rejection input speaker-In (for OEM head units) and RCA-In (for Aftermarket head units) inputs.
- ART (Automatic Remote Turn-On/Off) automatically turns on/off the amplifier when the OEM head-unit turns on/off (can be enabled/ disabled, with Speaker-In inputs).
- Pre-outs, also available when using Speaker-In level inputs.
- Mono operation mode (selectable), to create a sub + front three-channel system or a powerful 2-channel system.
- Bass Boost (50 Hz) adjustable to 12 dB, to increase the subwoofer punch.
- Lo-Pass and Hi-Pass 12 dB adjustable (50 Hz to 3200 Hz) filters, providing the ability to build a front + rear system, a multichannel woofer + tweeter system or a powerful sub + front system.

PRODUCT CODE  
**82 SR4300**



**AUDISON**  
**500W X 1 SR 1.500 MONO**  
**D-CLASS AMPLIFIER**

The Audison SR 1.500 Amplifier is for the SR Line of Audison, featuring high power amplifiers with a compact design. SR 1.500's compact design and extruded aluminium chassis with rounded corners, makes it easy to install in narrow spaces.

- ADC (Audison D-Class) Technology stable output stage ensuring high audio performance in a compact size.
- Extruded aluminium compact design with fan less convection cooling system.
- Built-in USS (Universal Speakers Simulator).
- Balanced high-noise rejection input speaker-In (for OEM head units) and RCA-In (for Aftermarket head units) inputs.
- ART (Automatic Remote Turn-On/Off) automatically turns on/off the amplifier when the OEM head-unit turns on/off (can be enabled/ disabled, with Speaker-In inputs).
- Pre-outs, also available when using Speaker-In level inputs.
- 5 ch/3 ch operation mode (selectable), to create a five-channel system (with sub), or a powerful sub + front three-channel system.
- Bass Boost (50 Hz) adjustable to 12 dB, to increase the subwoofer punch.
- Lo-Pass and Hi-Pass 12 dB adjustable (50 Hz to 3200 Hz) filters, providing the ability to build a front + rear system, a multichannel woofer + tweeter system or a powerful sub + front system.

PRODUCT CODE  
**82 SR1500**



**AUDISON**  
**125W X 4 SR 4.500 4-CHANNEL**  
**D-CLASS AMPLIFIER**

The Audison SR 4.500 Amplifier is for the SR Line of Audison, featuring high power amplifiers with a compact design. SR 4.500's compact design and extruded aluminium chassis with rounded corners, makes it easy to install in narrow spaces.

- ADC (Audison D-Class) Technology stable output stage ensuring high audio performance in a compact size.
- Extruded aluminium compact design with fan less convection cooling system.
- Built-in USS (Universal Speakers Simulator).
- Balanced high-noise rejection input speaker-In (for OEM head units) and RCA-In (for Aftermarket head units) inputs.
- ART (Automatic Remote Turn-On/Off) automatically turns on/off the amplifier when the OEM head-unit turns on/off (can be enabled/ disabled, with Speaker-In inputs).
- Pre-outs, also available when using Speaker-In level inputs.
- Mono operation mode (selectable), to create a sub + front three-channel system or a powerful 2-channel system.
- Bass Boost (50 Hz) adjustable to 12 dB, to increase the subwoofer punch.
- Lo-Pass and Hi-Pass 12 dB adjustable (50 Hz to 3200 Hz) filters, providing the ability to build a front + rear system, a multichannel woofer + tweeter system or a powerful sub + front system.

PRODUCT CODE  
**82 SR4500**



**AUDISON**  
**75W X 4 + 300W X 1 SR 5.600**  
**5-CHANNEL D-CLASS AMPLIFIER**

The Audison SR 5.600 Amplifier is for the SR Line of Audison, featuring high power amplifiers with a compact design. SR 5.600's compact design and extruded aluminium chassis with rounded corners, makes it easy to install in narrow spaces.

- ADC (Audison D-Class) Technology stable output stage ensuring high audio performance in a compact size.
- Built-in USS (Universal Speakers Simulator).
- Balanced high-noise rejection input speaker-In (for OEM head units) and RCA-In (for Aftermarket head units) inputs.
- ART (Automatic Remote Turn-On/Off) automatically turns on/off the amplifier when the OEM head-unit turns on/off (can be enabled/ disabled, with Speaker-In inputs).
- Pre-outs, also available when using Speaker-In level inputs.
- 5 ch/3 ch operation mode (selectable), to create a five-channel system (with sub), or a powerful sub + front three-channel system.
- Bass Boost (50 Hz) adjustable to 12 dB, to increase the subwoofer punch.
- Lo-Pass and Hi-Pass 12 dB adjustable (50 Hz to 3200 Hz) filters, providing the ability to build a front + rear system, a multichannel woofer + tweeter system or a powerful sub + front system.
- 24 dB continuous adjustable (50 to 500 Hz) Lo-Pass subwoofer filter.

PRODUCT CODE  
**82 SR5600**



**AUDISON**  
**SIGNAL INTERFACE PROCESSOR**

Provided with a 32bit, 147MHz clock speed DSP as well as 24 bit A/D and D/A converters, bit Ten is controlled by a software especially developed for signal treatment according to the vehicle acoustic peculiarities.

- Auto tuning by Audison bit Tune and communication with bit Drive portal.
- De-equalization function to flatten any equalization applied by default by OEM sources.
- 5 individual low level outputs that can be assigned to suit your system or application.
- 4 high level master inputs & 1 low level RCA AUX input.

PRODUCT CODE  
**82 BITTEN**



**WHAT FITS YOUR CAR?**

**VEHICLE SPECIFIC INSTALLATION PARTS**

Install Kits, Facia Kits, Harnesses, Adaptors & Speaker Spacers

**CAR AUDIO ACCESSORIES**

Amplifier & Speaker Installation Parts



Cables, Chargers, Bluetooth, FM Transmitters & Magnetic Holders



Antennas & Brackets



Vibration Damping, Sound Insulation, Sound Absorption & Thermal Protection

**DIGITAL CONNECTIVITY**

**UHF RADIO ACCESSORIES**

**SOUND PROOFING MATERIALS**

**DASH CAMS**

**GATOR DRIVER ASSIST**

**REVERSE CAMS**



[gatordriverassist.com](http://gatordriverassist.com)



**AUDI**



**AERPRO FACIA AUDI A3 DOUBLE DIN**

This facia kit is suitable for mounting an aftermarket headunit into your vehicle, giving your new stereo installation a professional look. The grade of ABS plastic used ensures long life of the kit and a high quality finished designed to match the vehicles dashboard.

- High grade ABS plastic ensures long life of the facia kit.
- High quality finish designed to match the vehicle dashboard.

PRODUCT CODE  
**70 FP9090**



**AERPRO FACIA AUDI A4 S-DIN & POCKET**

This facia kit is suitable for mounting an aftermarket headunit into your vehicle, giving your new stereo installation a professional look. The grade of ABS plastic used ensures long life of the kit and a high quality finish designed to match the vehicle's dashboard.

- Single DIN and pocket.
- Suits : A4 02-on.
- High grade ABS plastic ensures long life of the facia kit.
- High quality finish designed to match the vehicle dashboard.

PRODUCT CODE  
**70 FP9102**

**BMW**

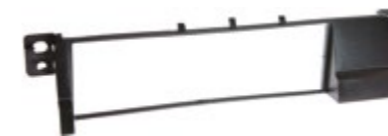

**AERPRO FACIA - BMW 3 SERIES 1998-2005**

This facia kit is suitable for mounting an aftermarket headunit into your vehicle, giving your new stereo installation a professional look. The grade of ABS plastic used ensures long life of the kit and a high quality finished designed to match the vehicle's dashboard.

- Single DIN facia plate.
- Suits: E46 3 Series.

PRODUCT CODE  
**70 FP8023**



**AERPRO FACIA BMW SERIES 1-3 PLATE**

This facia kit is suitable for mounting an aftermarket headunit into your vehicle, giving your new stereo installation a professional look. The grade of ABS plastic used ensures long life of the kit and a high quality finish designed to match the vehicle's dashboard.

- Suits: 1 Series E87, 3 Series E90 04-on.
- Colour: Black.
- High grade ABS plastic ensures long life of the facia kit.
- High quality finish designed to match the vehicle dashboard.

PRODUCT CODE  
**70 FP9134**

Aerpro's extensive range of Facia kits, Steering Wheel Controls and Harnesses help you install an aftermarket headunit into your vehicle without damaging your cars existing wiring.

[aerpro.com](http://aerpro.com)

**FORD**



**AERPRO FACIA DOUBLE DIN FALCON AU BLACK**

This facia kit is suitable for mounting an aftermarket headunit into your vehicle, giving your new stereo installation a professional look. The grade of ABS plastic used ensures long life of the kit and a high quality finish designed to match the vehicle's dashboard.

- High grade ABS plastic ensures long life of the facia kit
- High quality finish designed to match the vehicle dashboard
- Includes metal mounting brackets for easy installation

PRODUCT CODE  
**70 FP9240**



**AERPRO FASCIA PANEL BA-BF TERRITORY**

This facia kit is suitable for mounting an aftermarket headunit into your vehicle, giving your new stereo installation a professional look. The grade of ABS plastic used ensures long life of the kit and a high quality finish designed to match the vehicle's dashboard.

- Single DIN facia.
- Fits both manual and auto vehicles.
- Colour: Gun metal grey.

PRODUCT CODE  
**70 FP9042M**



**AERPRO POCKET FACIA AU SERIES 1-3 BLACK**

This facia kit is suitable for mounting an aftermarket headunit into your vehicle, giving your new stereo installation a professional look. The grade of ABS plastic used ensures long life of the kit and a high quality finish designed to match the vehicle's dashboard.

- Facia and under radio pocket.
- Supplied: metal mounting brackets.
- Suits: Falcon AU Series 1,2,3.
- High grade ABS plastic ensures long life of facia kit.
- High quality finish designed to match the vehicle dashboard.
- Includes mounting brackets for easy installation.

PRODUCT CODE  
**70 FP9140**



**AERPRO POCKET BA-BF FALCON DUAL USB**

This facia kit is suitable for mounting an aftermarket headunit into your vehicle, giving your new stereo installation a professional look. The grade of ABS plastic used ensures long life of the kit and a high quality finish designed to match the vehicle's dashboard.

- Facia panel and storage pocket.
- Dual USB charging points.
- Auto transmission vehicles only.
- USB ports charge up to 0.5A each.
- Adjustable head unit mounting brackets supplied.

PRODUCT CODE  
**70 FP9042**



**AERPRO DOUBLE DIN GUNMETAL INSTALL KIT TO SUIT FORD FALCON**

Complete a full aftermarket headunit installation in your Ford Falcon BA-BF or Territory SX-SY, single and dual zone variants, from start to finish with this Aerpro vehicle specific headunit installation kit.

- When installing this facia kit, please only use a screwdriver to hand tighten the screws. Using a power tool may overtighten the screws and damage the facia kit.
- Aftermarket headunit must be SWC compatible and Steering wheel control functions may vary from the OEM functions.
- Mechless shallow mount headunits recommended for easier installation due to their mounting depth.
- This kit is designed for aftermarket AV double din headunits with an RCA camera input.
- Dual USB ports are pass through only, to operate they must be connected to USB ports on the rear of the aftermarket headunit (if available).
- Vehicles with OEM reverse sensors will require additional parts sold separately to retain reversing tone, Aerpro AP1WAMP audio amplifier & CBXS extension speaker.
- Headunit ISO harness not included in the kit.

PRODUCT CODE  
**70 FP9750GK GUNMETAL GREY**  
**70 FP9750SK SILVER**



**AERPRO FACIA FORD S-DIN & POCK BLK**

This facia kit is suitable for mounting an aftermarket headunit into your vehicle, giving your new stereo installation a professional look. The grade of ABS plastic used ensures long life of the kit and a high quality finish designed to match the vehicle's dashboard.

- Single DIN and pocket.
- Suits: Focus 05-on, Fiesta 06-08, Transit 06-on.

PRODUCT CODE  
**70 FP9144**



**AERPRO FACIA FORD RANGER 2007-10**

This facia is a high quality tailor-made panel that will enable the installation of either a double or single DIN headunit. It features cutouts for factory hazard lights button, A/C and rear demister buttons plus heater/cooling controls.

- Single/double DIN facia.
- Colour: Silver.
- Cutouts for factory buttons and heater/cooling controls.
- High grade ABS plastic ensures long life of the facia kit
- High quality finish designed to match the vehicle dashboard
- FP9014 Pocket is required for single din installation (sold separately).
- FP8020 Mounting Cage is required for double din installation (sold separately).

PRODUCT CODE  
**70 FP9072**



**AERPRO FACIA - FORD FOCUS & TRANSIT**

This facia kit is suitable for mounting an aftermarket headunit into your vehicle, giving your new stereo installation a professional look. The grade of ABS plastic used ensures long life of the kit and a high quality finish designed to match the vehicles dashboard.

- High grade ABS plastic ensures long life of facia kit.
- High quality finish designed to match the vehicle dashboard.
- Includes mounting brackets for easy installation.

PRODUCT CODE  
**70 955806**

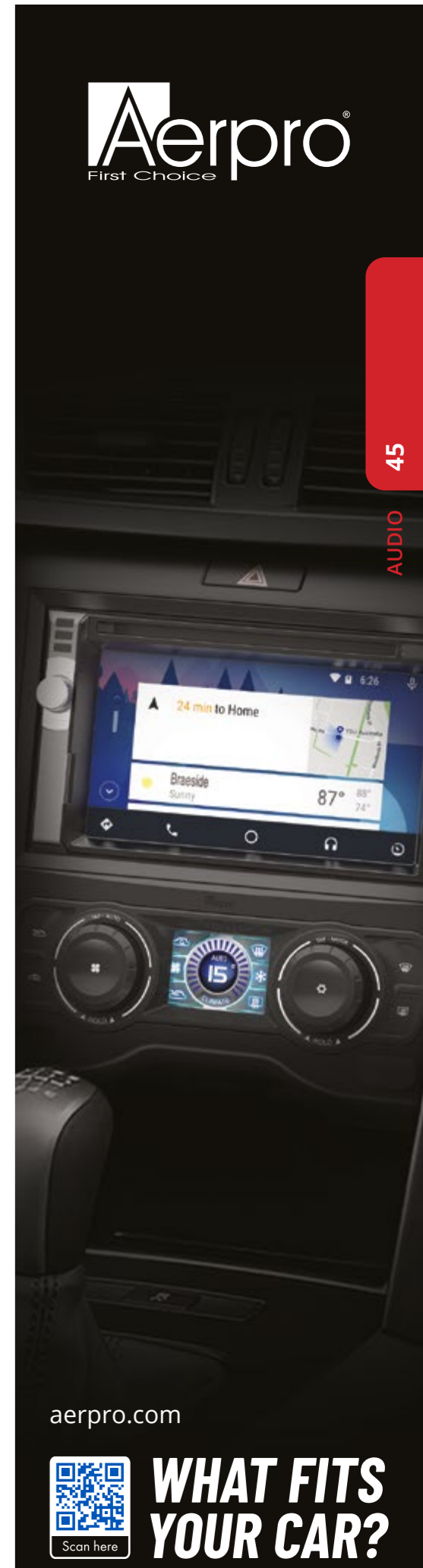

aerpro.com



**WHAT FITS YOUR CAR?**

44 AUDIO

45 AUDIO





■ HOLDEN



**AERPRO FACIA INSTALLATION KIT - HOLDEN COMMODORE VT-VX**

Complete a full aftermarket double din headunit installation in your Holden Commodore from start to finish with this Aerpro vehicle specific headunit installation kit, containing everything you need for a perfect upgrade in one box.

- Kit includes all the parts required to complete an installation of an aftermarket headunit conveniently in one box
- Suitable for double din aftermarket headunit installation
- High quality black finish on facia kit to suit the style of the dashboard in the vehicle
- Retains steering wheel control functionality
- Includes OEM headunit removal keys for easy removal of factory headunit
- To simplify installation, this kit is compatible with Aerpro APP8 and APP9 aftermarket headunit harness adapters

PRODUCT CODE  
**70 FP8018K**



**AERPRO POCKET FACIA VT-VX COMMODORE**

This facia kit is suitable for mounting an aftermarket headunit into your vehicle, giving your new stereo installation a professional look. The grade of ABS plastic used ensures long life of the kit and a high quality finish designed to match the vehicle's dashboard.

- Fits single DIN to original double DIN enclosure.
- OEM design for the perfect fit.
- Includes metal mounting brackets.
- Rear load unit mount.
- Easy snap on installation.

PRODUCT CODE  
**70 FP9018**



**AERPRO FACIA - HOLDEN VT-VX**

This facia kit is suitable for mounting an aftermarket head unit into your vehicle, giving your new stereo installation a professional look. The grade of ABS plastic used ensures long life of the kit and a high quality finished designed to match the vehicle's dashboard.

- Custom black facia panel.
- Use to fit double din audio units.
- High grade ABS plastic ensures long life of facia kit.
- High quality finish designed to match the vehicle dashboard.
- Includes mounting brackets for easy installation.

PRODUCT CODE  
**70 FP8018**



**AERPRO FACIA VY COMMODORE DOUBLE DIN BLACK**

This facia kit is suitable for mounting an aftermarket head unit into your vehicle, giving your new stereo installation a professional look. The grade of ABS plastic used ensures long life of the kit and a high quality finish designed to match the vehicles dashboard.

- Double DIN.
- Fits into original DIN enclosure.
- Colour: Black
- Also available in grey.

PRODUCT CODE  
**70 FP9056 BLACK**  
**70 FP9056G GREY**

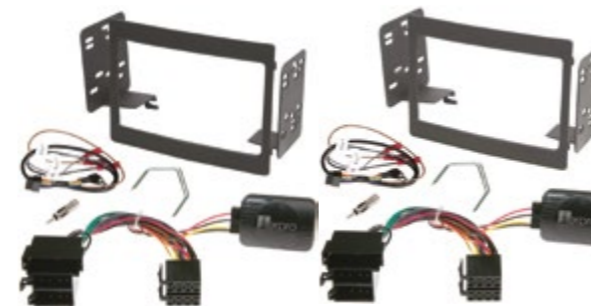

**AERPRO FACIA INSTALL KIT D/DIN GREY FOR VY/VZ**

Install kit to suit Holden VY/VZ, which includes grey double DIN facia, steering wheel control harness, and removal keys for factory head-unit.

- Kit includes all the parts required to complete an installation of an aftermarket headunit conveniently in one box
- Suitable for double din aftermarket headunit installation
- High quality grey finish on facia kit to suit the style of the dashboard in the vehicle
- Retains steering wheel control functionality
- Includes OEM headunit removal keys for easy removal of factory headunit
- To simplify installation, this kit is compatible with Aerpro APP8 and APP9 aftermarket headunit harness adapters

PRODUCT CODE  
**70 FP9056K BLACK**  
**70 FP9056GK GREY**



**AERPRO FACIA SINGLE DIN COLOUR MATCH VY/VZ**

This facia kit is suitable for mounting an aftermarket headunit into your vehicle, giving your new stereo installation a professional look. The grade of ABS plastic used ensures long life of the kit and a high quality finish designed to match the vehicle's dashboard.

- Used for fitting a single DIN aftermarket radio.
- Provides the best colour match to factory dash.
- Includes mounting brackets and non-slip rubber mat.
- Black.

PRODUCT CODE  
**70 FP9046B1 BLACK**  
**70 FP9046G1 GREY**



**AERPRO FACIA INSTALL KIT S/DIN BLACK FOR VY/VZ**

This Aerpro install kit allows you to install a single DIN aftermarket headunit into your vehicle whilst retaining full control from the buttons on your steering wheel.

- Install kit to suit Holden VY/VZ.
- Includes black facia and pocket.
- Steering wheel control harness.
- Removal keys for factory head-unit.

PRODUCT CODE  
**70 FP9046K**



■ HOLDEN (CONTINUED)



**AERPRO  
POCKET TO SUIT HOLDEN  
COMMODORE VE SERIES**

Engineered to replace the factory lid compartment in the centre console of various dual zone climate control models, the pocket suits the vehicle interior and is made from high quality plastics offering an OEM look and feel.

- Perfect accessory for Holden Commodore VE Series 1 & 2 2006-2013 vehicles, engineered to fit in the centre console of the vehicle seamlessly.
- Designed to replace the factory lid compartment found in most dual zone climate control models in the center console when installing an Aerpro FP9450BK Total Installation Kit.
- Gap-free vehicle specific design to provide a seamless integration solution.
- High grade ABS plastic to withstand heat and UV rays.
- Anti-skid rubber finish for secure mounting of the smartphone.

PRODUCT CODE  
**70 WC62P**

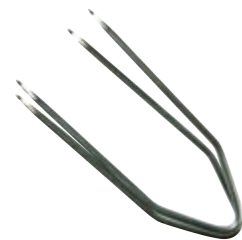

**AERPRO  
RADIO REMOVAL KEYS (PAIR) FORD,  
HOLDEN & RENAULT**

The radio removal keys is made with strong steel for simple removal of factory radios without damaging or scratching the head unit. Simple insertion of one tool on each side of the factory radio allows you to pull out the vehicles factory radio easily.

- Suits Ford AU Falcon and Holden VT-VU-VX factory fitted head units.

PRODUCT CODE  
**70 APFHRK**



**AERPRO  
INSTALL KIT TO SUIT HOLDEN VE**

This double DIN headunit install kit is suited for the Holden Commodore. It is used for fitting a double DIN aftermarket radio, CD or DVD player to the original double DIN enclosure.

- Includes digital climate control.
- Multi-function digital display.
- Spin, tap or hold the soft touch rotary dial.
- Capacitive touch buttons.
- Auto climate control with USB charging ports.
- Retains steering wheel control functionality including phone button
- If installing a single din aftermarket headunit, use FP6405 pocket in conjunction with this kit (sold separately)
- To simplify installation, this kit is compatible with Aerpro APP8 and APP9 aftermarket headunit harness adapters

PRODUCT CODE  
**70 FP9350BK BLACK**  
**70 FP9350GK GREY**



**AERPRO  
INSTALL KIT TO SUIT HOLDEN VE DUAL ZONE**

Complete a full aftermarket double din headunit installation in your Holden Commodore VE Series 1 (2006-2011) with dual zone climate control, from start to finish with this Aerpro vehicle specific headunit installation kit, containing everything you need for a perfect upgrade in one box.

- Kit includes all the parts required to complete an installation of an aftermarket headunit conveniently in one box.
- Suitable for double din aftermarket headunit installation.
- If installing a single din aftermarket headunit, use FP6405 pocket in conjunction with this kit (sold separately).
- For vehicles with the flip door tray under the factory head unit.
- High quality gunmetal grey finish on facia kit to suit the style of the dashboard in the vehicle.
- Suitable for use in HSV models (GTS, Senator, Maloo), Clubsport models (R8), Holden models (SSV, Calais, Berlina, Selected SS's); all variants, Wagon, Ute and Sedan.
- Retains steering wheel control functionality including phone button.
- Includes digital climate control, soft touch rotary dials with spin, tap or hold dial functions, multi-function digital display.
- Built in USB pass through to connect to aftermarket headunit for android auto and carplay.

PRODUCT CODE  
**70 FP9450BK BLACK**  
**70 FP9450GK GREY**

■ HOLDEN/ISUZU



**AERPRO  
FACIA - HOLDEN & ISUZU**

This facia kit is suitable for mounting an aftermarket headunit into your vehicle, giving your new stereo installation a professional look. The grade of ABS plastic used ensures long life of the kit and a high quality finish designed to match the vehicle's dashboard.

- High grade ABS plastic ensures long life of facia kit.
- High quality finish designed to match the vehicle dashboard.
- Includes mounting brackets for easy installation.

PRODUCT CODE  
**70 FP8061**



**AERPRO  
DOUBLE DIN HEADUNIT  
INSTALLATION KIT HOLDEN & ISUZU  
VARIOUS**

Complete a full aftermarket double din headunit installation in your Holden Colorado from start to finish with this Aerpro vehicle specific headunit installation kit, containing everything you need for a perfect upgrade in one box.

- Suitable for double din aftermarket headunit installation.
- High quality black finish on facia kit to suit the style of the dashboard.
- Retains steering wheel control functionality including phone button.
- To simplify installation, this kit is compatible with Aerpro APP8 and APP9 aftermarket headunit harness adapters.

PRODUCT CODE  
**70 FP8061K**

■ HYUNDAI



**AERPRO  
FACIA HYUNDAI SANTA FE 070N  
D-DIN**

This facia kit is suitable for mounting an aftermarket headunit into your vehicle, giving your new stereo installation a professional look. The grade of ABS plastic used ensures long life of the kit and a high quality finish designed to match the vehicle's dashboard.

- Double DIN/ISO kit.
- High grade ABS plastic ensures long life.
- High quality finish designed to match the vehicle dashboard.
- Includes mounting brackets for easy installation.

PRODUCT CODE  
**70 FP957325**



**AERPRO  
FACIA HYUNDAI IX35**

This facia kit is suitable for mounting an aftermarket headunit into your vehicle, giving your new stereo installation a professional look. The grade of ABS plastic used ensures long life of the kit and a high quality finished designed to match the vehicles dashboard.

- High grade ABS plastic ensures long life of the facia kit.
- High quality finish designed to match the vehicle dashboard
- Includes mounting brackets for easy installation

PRODUCT CODE  
**70 FP9035**



**AERPRO  
FACIA BLACK - HYUNDAI ILOAD**

This facia kit is suitable for mounting an aftermarket headunit into your vehicle, giving your new stereo installation a professional look. The grade of ABS plastic used ensures long life of the kit and a high quality finished designed to match the vehicles dashboard.

- High grade ABS plastic ensures long life of facia kit
- High quality finish designed to match the vehicle dashboard
- Includes mounting brackets for easy installation

PRODUCT CODE  
**70 FP7320**

■ JEEP



**AERPRO FACIA JEEP WRANG-CHERO 97-01**

This facia kit is suitable for mounting an aftermarket headunit into your vehicle, giving your new stereo installation a professional look. The grade of ABS plastic used ensures long life of the kit and a high quality finish designed to match the vehicle's dashboard.

- Suits: Cherokee 97-01, Grand Cherokee 96-98, Wrangler 97-02.
- High grade ABS plastic ensures long life of the facia kit.
- High quality finish designed to match the vehicle dashboard.
- Includes mounting brackets for easy installation.

PRODUCT CODE  
**70 FP9050**

■ LEXUS



**AERPRO FACIA KIT TO SUITS LEXUS**

This facia kit is suitable for mounting an aftermarket headunit into your vehicle, giving your new stereo installation a professional look. The grade of ABS plastic used ensures long life of the kit and a high quality finished designed to match the vehicles dashboard.

- High grade ABS plastic ensures long life of facia kit
- High quality finish designed to match the vehicle dashboard
- Includes mounting brackets and instructions for easy installation

PRODUCT CODE  
**70 FP8357**

■ MAZDA



**AERPRO FACIA - MAZDA AXELA 2009-13**

This facia kit is suitable for mounting an aftermarket headunit into your vehicle, giving your new stereo installation a professional look. The grade of ABS plastic used ensures long life of the kit and a high quality finished designed to match the vehicle's dashboard.

- Double DIN facia kit.
- Suits: Mazda 3 2010 to 2012.
- High grade ABS plastic ensures long life of facia kit.
- High quality finish designed to match the vehicle dashboard.
- Includes mounting brackets for easy installation.

PRODUCT CODE  
**70 FP8072**

■ MERCEDES



**AERPRO FACIA MERCEDES DOUBLE DIN**

This facia kit is suitable for mounting an aftermarket headunit into your vehicle, giving your new stereo installation a professional look. The grade of ABS plastic used ensures long life of the kit and a high quality finish designed to match the vehicle's dashboard.

- Double DIN facia.
- Suits: Mercedes A Class 05-on, B Class, Sprinter 06-on, Viano 06-on, Vito & VW Crafter.
- High grade ABS plastic ensures long life of the facia kit.
- High quality finish designed to match the vehicle dashboard.

PRODUCT CODE  
**70 FP9092**

■ MITSUBISHI



**AERPRO UNIVERSAL HEADUNIT POCKET - MITSUBISHI & HOLDEN**

Facia Kits allow for the installation of an aftermarket stereo system where the factory radio face or opening is not DIN or double DIN standard.

- Universal single DIN pocket
- Suits various Mitsubishi vehicles

PRODUCT CODE  
**70 FP6405**



**AERPRO FACIA MITSUBISHI OUTLANDER**

This facia kit is suitable for mounting an aftermarket headunit into your vehicle, giving your new stereo installation a professional look. The grade of ABS plastic used ensures long life of the kit and a high quality finish designed to match the vehicles dashboard.

- High grade ABS plastic ensures long life of the facia kit
- High quality finish designed to match the vehicle dashboard
- Includes mounting brackets for easy installation

PRODUCT CODE  
**70 FP9110**



**AERPRO S/DIN FACIA KIT TO SUIT MAZDA 6 BLACK**

This Aerpro Facia Kit is suitable for mounting a Single Din aftermarket headunit into your Mazda 6 giving your new stereo installation a professional gap-free look. The high quality finish, colour and texture are designed specifically to complement the original look of your vehicles interior.

- Provides a professional gap-free installation solution
- High quality black textured finish to suit the style of the dashboard in the vehicle
- High grade ABS plastic to withstand heat and UV rays, ensures long life of the facia kit
- Aftermarket radio mounts at the top of the dashboard, replacing the factory pocket/compartement

PRODUCT CODE  
**70 FP8452**



**AERPRO FACIA MAZDA 6 2008-10**

This facia kit is suitable for mounting an aftermarket headunit into your vehicle, giving your new stereo installation a professional look. The grade of ABS plastic used ensures long life of the kit and a high quality finish designed to match the vehicle's dashboard.

- Single/double DIN facia.
- High grade ABS plastic ensures long life of the facia kit.
- High quality finish designed to match the vehicle dashboard.
- Includes mounting brackets for easy installation.

PRODUCT CODE  
**70 FP9066**



**AERPRO FACIA MAZDA MULTI-KIT 2001 ON**

This facia kit is suitable for mounting an aftermarket headunit into your vehicle, giving your new stereo installation a professional look. The grade of ABS plastic used ensures long life of the kit and a high quality finish designed to match the vehicle's dashboard.

- DIN facia and pocket.
- Supplied: Trim plate and mounting brackets.
- Suits: Protégé 01-04, Tribute 01-05.
- Application: Single and double Din.

PRODUCT CODE  
**70 FP997505**

■ NISSAN

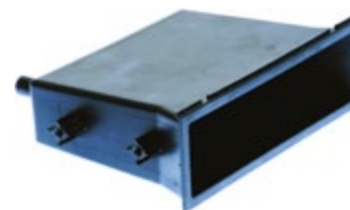

**AERPRO POCKET UNIVERSAL NISSAN**

This facia kit is suitable for mounting an aftermarket head unit into your vehicle, giving your new stereo installation a professional look. The grade of ABS plastic used ensures long life of the kit and a high quality finish designed to match the vehicles dashboard.

- Universal Nissan pocket.
- Screws in.

PRODUCT CODE  
**70 FP9043**

■ SUBARU



**AERPRO FACIA - SUBARU FORESTER 2013+ IMPREZA 2012+ XV 2012+**

Facia Kits allow for the installation of an aftermarket stereo system where the factory radio face or opening is not DIN or double DIN standard. Our facia kits are specific to your vehicle and our range covers most vehicles in the Australasian market.

- Suits: Subaru - Forester 2013 - On, Impreza 2012 - On & XV 2012- On.

PRODUCT CODE  
**70 958905B**



**AERPRO FACIA TO SUIT SUBARU**

Facia Kits allow for the installation of an aftermarket stereo system where the factory radio face or opening is not DIN or double DIN standard.

- Subaru IMPREZA/WRX 2008-up, Forester 2008-up, Double DIN Radio Provision, Stacked ISO Mount Units Provision

PRODUCT CODE  
**70 FP958902**

■ SUZUKI



**AERPRO  
DOUBLE DIN FACIA FOR SUZUKI**

This facia kit is suitable for mounting an aftermarket headunit into your vehicle, giving your new stereo installation a professional look. The grade of ABS plastic used ensures long life of the kit and a high-quality finish designed to match the dashboard of the vehicle.

- To Suit Suzuki: Grand Vitara 2006 - 2010.
- High grade ABS plastic ensures long life of facia kit.
- High quality finish designed to match the vehicle dashboard.
- Includes mounting brackets for easy installation.

PRODUCT CODE  
**70 FP8165**



**AERPRO  
FACIA SINGLE/DOUBLE DIN FOR SUZUKI**

This facia kit is suitable for mounting an aftermarket headunit into your vehicle, giving your new stereo installation a professional look. The grade of ABS plastic used ensures long life of the kit and a high quality finished designed to match the vehicles dashboard.

- High grade ABS plastic ensures long life of facia kit
- High quality finish designed to match the vehicle dashboard

PRODUCT CODE  
**70 FP8174**



**AERPRO  
FACIA - SUZUKI SWIFT 2011-17**

This facia kit is suitable for mounting an aftermarket headunit into your vehicle, giving your new stereo installation a professional look. The grade of ABS plastic used ensures long life of the kit and a high quality finish designed to match the vehicle's dashboard.

- High grade ABS plastic ensures long life of facia kit.
- High quality finish designed to match the vehicle dashboard.
- Includes mounting brackets for easy installation.

PRODUCT CODE  
**70 FP8016**



**AERPRO  
POCKET FACIA SWIFT 2005 ON**

This Aerpro install kit allows you to install a double DIN aftermarket headunit into your vehicle whilst retaining full control from the buttons on your steering wheel.

- Includes steering wheel control interface and universal patch lead for most aftermarket head-units.
- Double ISO facia with pocket.
- Colour: Black.
- External Dimensions: W: 278mm x H: 136mm.

PRODUCT CODE  
**70 FP9049**



**AERPRO  
FACIA INSTALL KIT SUZUKI SWIFT**

This Aerpro install kit allows you to install a double DIN aftermarket headunit into your vehicle whilst retaining full control from the buttons on your steering wheel.

- Install kit to suit Suzuki Swift 2005 - 2010.
- Includes facia and pocket.
- Steering wheel control harness.

PRODUCT CODE  
**70 FP9049K**

■ TOYOTA



**AERPRO  
FACIA - TOYOTA AVENSIS 2003-09**

This facia kit is suitable for mounting an aftermarket headunit into your vehicle, giving your new stereo installation a professional look. The grade of ABS plastic used ensures long life of the kit and a high quality finish designed to match the vehicles dashboard.

- High grade ABS plastic ensures long life of facia kit
- High quality finish designed to match the vehicle dashboard

PRODUCT CODE  
**70 FP6421**



**AERPRO  
FACIA - TOYOTA BLADE 2006-11**

This facia kit is suitable for mounting an aftermarket double din headunit into your Toyota Blade (2006-2011), giving your new stereo installation a professional look. The facia kit is made from high quality ABS plastic that has been heat and UV tested to ensure longevity.

- Suitable for double din aftermarket headunit installation
- High quality grey finish to suit the style of the dashboard in the vehicle
- High grade ABS plastic to withstand heat and UV rays, ensures long life of facia kit
- Precision mounting tabs make the installation easy and secure

PRODUCT CODE  
**70 FP6426**



**AERPRO  
FACIA - TOYOTA COROLLA 2007-11**

This facia kit is suitable for mounting an aftermarket headunit into your vehicle, giving your new stereo installation a professional look. The grade of ABS plastic used ensures long life of the kit and a high quality finish designed to match the vehicles dashboard.

- High grade ABS plastic ensures long life of facia kit
- High quality finish designed to match the vehicle dashboard
- Includes mounting brackets for easy installation

PRODUCT CODE  
**70 FP6422**



**AERPRO  
FACIA - TOYOTA & SUBARU  
VARIOUS MODELS**

Facia Kits allow for the installation of an aftermarket stereo system where the factory radio face or opening is not DIN or double DIN standard. Our facia kits are specific to your vehicle and our range covers most vehicles.

- Double DIN Toyota side facia brackets.
- Fills Left and Right hand side gaps.

PRODUCT CODE  
**70 ATB2  
70 ATB2GB GLOSS BLACK**



**AERPRO  
DOUBLE DIN HEADUNIT USB & AUX  
SIDE 'WINGS' - TOYOTA & SUBARU**

This facia kit is suitable for mounting an aftermarket headunit into your vehicle, giving your new stereo installation a professional look. The grade of ABS plastic used ensures long life of the kit and a high quality finished designed to match the vehicles dashboard.

- Toyota side wings for mounting a double DIN headunit.
- Includes USB and 3.5mm stereo sockets to link to back of aftermarket headunit.

PRODUCT CODE  
**70 ATB3USB**



**AERPRO  
POCKET TO SUIT TOYOTA**

This facia kit is suitable for mounting an aftermarket headunit into your vehicle, giving your new stereo installation a professional look. The grade of ABS plastic used ensures long life of the kit and a high quality finish designed to match the vehicle's dashboard.

- Under radio storage pocket.
- Suits: Various Toyota and Nissan models.
- Supplied: Left and right mounting brackets.
- ABS plastic.
- Colour: Black.

PRODUCT CODE  
**70 FP9016  
70 FP9016GB GLOSS BLACK**

■ TOYOTA (CONTINUED)



**AERPRO FACIA TOYOTA HILUX 2012 ON**

This facia kit is suitable for mounting an aftermarket headunit into your vehicle, giving your new stereo installation a professional look. The grade of ABS plastic used ensures long life of the kit and a high quality finish designed to match the vehicle's dashboard.

- Double DIN trim plate and brackets.
- Suits: Toyota Hilux 2012 onwards.

PRODUCT CODE  
**70 FP9026**



**AERPRO FACIA SINGLE DIN VW BEETLE**

This facia kit is suitable for mounting an aftermarket headunit into your vehicle, giving your new stereo installation a professional look. The grade of ABS plastic used ensures long life of the kit and a high quality finish designed to match the vehicle's dashboard.

- To Suit VW: Beetle 1998 - 2010.
- High grade ABS plastic ensures long life of facia kit.
- High quality finish designed to match the vehicle dashboard.

PRODUCT CODE  
**70 FP8166**

■ VOLKSWAGEN



**AERPRO D/DIN FACIA KIT T/S VOLKSWAGEN VARIOUS**

This facia kit is suitable for mounting an aftermarket double din headunit into your Volkswagen. The grade of ABS plastic used ensures long life of the kit and a high quality finish design to match the vehicles dashboard.

- Suitable for double din aftermarket headunit installation
- High quality black finish on facia kit to suit the style of the dashboard in the vehicle
- High grade ABS plastic to withstand heat and UV rays ensures long life of the facia kit
- Includes mounting brackets for easy installation

PRODUCT CODE  
**70 FP9888**



**AERPRO INSTALL KIT TO SUIT VARIOUS VOLKSWAGEN**

Complete a full aftermarket double din headunit installation from start to finish with this Aerpro vehicle specific headunit installation kit, containing everything you need for a perfect upgrade in one box.

- Kit includes all the parts required to complete an installation of an aftermarket headunit conveniently in one box
- Suitable for double din aftermarket headunit installation
- High quality matte and gloss black finish on facia kit to suit the style of the dashboard in the vehicle
- Retains steering wheel control functionality including phone button
- CAN-BUS integration compatible, no additional modules required for CAN-BUS vehicles
- Suitable for OEM factory amplified and non amplified vehicles
- Provides output feeds for park brake, speed pulse and reverse gear
- To simplify installation, this kit is compatible with Aerpro APP8 and APP9 aftermarket headunit harness adapters

PRODUCT CODE  
**70 FP9888K**

■ UNIVERSAL



**AERPRO UNIVERSAL SINGLE DIN HEADUNIT REPLACEMENT POCKET**

These units are mostly used when installing a single DIN head unit into a Double DIN space. This pocket fits under an aftermarket radio when a double DIN style unit has been replaced.

- Pocket fits under aftermarket radio after double DIN unit has been replaced.
- Holds three CD jewel cases.
- Snap-on trim gives installation a factory look.

PRODUCT CODE  
**70 88009000**



**AERPRO UNIVERSAL UNDER DASH CAR RADIO HOUSING**

This housing provides a shaft or DIN installation space where no room was previously provided. Manufactured from UV stabilised ABS plastic.

- Creates a shaft or DIN installation space.
- UV stabilised ABS plastic.
- Dimensions: 89mm H x 254mm W x 229mm D.

PRODUCT CODE  
**70 AP9000**



**AERPRO FACIA & MOUNTING BRACKET KIT - UNIVERSAL**

This is an alternate way to fill the space of a DIN or JIN opening. These units are mostly used when installing a single DIN head unit into a Double DIN space.

- Universal double din mounting bracket and facia.
- Suits: Double Din applications that require a cage.
- Colour: Black.

PRODUCT CODE  
**70 FP8020**



**AERPRO UNIVERSAL DRINK & ACCESSORY POCKET**

The universal drink and accessory pocket is a handy fitting for both the DIN and JIN stereo spacing in your car. The product allows the user to have additional drink and accessory space in their car which is beneficial during long journeys.

- Top drawer has 3.5mm Aux input.
- Bottom drawer drops down to reveal cup holder.
- Fits both DIN and JIN stereo spacing.

PRODUCT CODE  
**70 FP9008BN**



**AERPRO UNIVERSAL DOUBLE DIN TRIM SURROUND - SUITS ALL VEHICLES**

This is an alternate way to fill the space of a DIN or JIN opening. These units are mostly used when installing a single DIN head unit into a Double DIN space.

- Universal Double Din Trim Surround

PRODUCT CODE  
**70 FP6425**



**AERPRO POCKET SNAP IN DIN**

This is an alternate way to fill the space of a DIN or JIN opening. These units are mostly used when installing a single DIN head unit into a Double DIN space.

- Snap in DIN pocket.
- Black finish.
- Easy to fit.

PRODUCT CODE  
**70 FP9014**



**AERPRO FACIA UNIVERSAL DOUBLE DIN MOUNT KIT**

This is an alternate way to fill the space of a DIN or JIN opening. These units are mostly used when installing a single DIN head unit into a double DIN space.

- Universal double DIN mounting bracket and facia.
- Side brackets.
- Suit: Alpine models IVA-W205R and IVA-W200Ri, Clarion models MAX668RVD and WXZ468RMP, Kenwood DDX6029/ DDX702, Pioneer HD1BT/ Avic D3.

PRODUCT CODE  
**70 FP953000**



**STANDARTPLAST GOLD LINE BIPLAST 10MM**

StP Biplast 10 from the Gold Line range is a sound-absorption, vibration-damping, heat-insulating, anti-squeak, self-adhesive material. It can be installed on clean metal or plastic surfaces, ideal installation areas include doors, roof, and plastic panels inside the vehicle.

- Sound-absorption, vibration-damping, heat-insulating, anti-squeak, self-adhesive material.
- Ideal for doors, roof and plastic interior panels.
- Designed to be installed on clean metal or plastic surfaces.
- Polyurethane layer with an adhesive base that is protected with anti-adhesive film.
- 10 sheets measuring 375 x 500mm each, providing a total coverage of 1.87m<sup>2</sup>.
- 10mm sheet thickness.

PRODUCT CODE  
**57 STPBIL10**



**STANDARTPLAST GOLD LINE BIPLAST 10MM SOUND PROOFING MATERIAL PACK**

StP Black-Silver Bulk Pack from the Silver Line range is a vibration-damping, sound-proofing, self-adhesive material, that is flexible and represents great value. StP Black-Silver can be used in vehicles, agricultural machinery, along with other applications.

- Great value vibration-damping, sound-proofing, self adhesive material.
- Ideal for doors, roofs, firewalls, wheel arches, boot compartments, bonnets and trimmings.
- Designed to be installed on clean metal surfaces.
- Ideal for car audio applications.
- Multi-layer construction material.
- Top is made from aluminium foil with embossing and printed logo.
- Base consists of an adhesive polymer layer protected with anti-adhesive paper.
- To improve anti-corrosion properties, the material also contains a corrosion inhibitor composition.
- 12 sheets measuring 750 x 500 mm each, providing a total coverage of 4.5m<sup>2</sup>.

PRODUCT CODE  
**57 STPBSP**



**STANDARTPLAST SILVER LINE BLACK-SILVER 1.8MM DOOR SOUND PROOFING MATERIAL**

StP Black-Silver Door Pack from the Silver Line range is a vibration-damping, sound-proofing, self-adhesive material, that is flexible and represents great value. StP Black-Silver can be used in vehicles, agricultural machinery, along with other applications.

- Great value vibration-damping, sound-proofing, self adhesive material.
- Ideal for doors, can also be used on: roofs, firewalls, wheel arches, boot compartments, bonnets and trimmings.
- Designed to be installed on clean metal surfaces.
- Ideal for car audio applications.
- Multi-layer construction material.
- Top is made from aluminium foil with embossing and printed logo.
- Base consists of an adhesive polymer layer protected with anti-adhesive paper.
- To improve anti-corrosion properties, the material also contains a corrosion inhibitor composition.
- 20 sheets measuring 375 x 265mm each, providing a total coverage of 2.0m<sup>2</sup>.

PRODUCT CODE  
**57 STPBSDP**



**STANDARTPLAST SILVER LINE BLACK-SILVER 1.8MM SPEAKER SOUND PROOFING MATERIAL**

StP Black-Silver Speaker Pack from the Silver Line range is a vibration-damping, sound-proofing, self-adhesive material, that is flexible and represents great value. StP Black-Silver can be used in vehicles, agricultural machinery, along with other applications.

- Great value vibration-damping, sound-proofing, self adhesive material.
- Ideal for doors, can also be used on: roofs, firewalls, wheel arches, boot compartments, bonnets and trimmings.
- Designed to be installed on clean metal surfaces.
- Ideal for car audio applications.
- Multi-layer construction material.
- Top is made from aluminium foil with embossing and printed logo.
- Base consists of an adhesive polymer layer protected with anti-adhesive paper.
- To improve anti-corrosion properties, the material also contains a corrosion inhibitor composition.
- 2 sheets measuring 375 x 265mm each, providing a total coverage of 0.2m<sup>2</sup>.

PRODUCT CODE  
**57 STPBSSK**



**STANDARTPLAST SILVER LINE BLACK-SILVER 1.8MM SHOP SOUND PROOFING MATERIAL**

StP Black-Silver Shop Pack from the Silver Line range is a vibration-damping, sound-proofing, self-adhesive material, that is flexible and represents great value. StP Black-Silver can be used in vehicles, agricultural machinery, along with other applications.

- Great value vibration-damping, sound-proofing, self adhesive material.
- Ideal for doors, roofs, firewalls, wheel arches, boot compartments, bonnets and trimmings.
- Designed to be installed on clean metal surfaces.
- Ideal for car audio applications.
- Multi-layer construction material.
- Top is made from aluminium foil with embossing and printed logo.
- Base consists of an adhesive polymer layer protected with anti-adhesive paper.
- To improve anti-corrosion properties, the material also contains a corrosion inhibitor composition.
- 8 sheets measuring 375 x 265mm each, providing a total coverage of 0.8m<sup>2</sup>.

PRODUCT CODE  
**57 STPBSSP**



**STANDARTPLAST SPECIAL LINE HOOD SOLUTION 10MM SOUND PROOFING MATERIAL**

StP Hood Solution 10 is a sound-insulating, self adhesive material designed specifically for your vehicle bonnet or boot. It has been designed to mount on clean metal surfaces and the recommended temperature range for it to perform is -45C to +100C.

- Sound-insulating, self-adhesive material.
- Ideal for under bonnets and boots lids.
- Designed to be installed on clean metal surfaces.
- Polyurethane layer with an adhesive base that is protected with anti-adhesive film.
- 10mm sheet thickness.
- 1 sheet measuring 1400 x 800mm, providing a total coverage of 1.12m<sup>2</sup>.

PRODUCT CODE  
**57 STPHS10**



**STANDARTPLAST CRYSTAL PRO SPEAKER KIT**

The Crystal Pro speaker kit comes with an industry leading 3 layer back wave dispersion pad, made from an aluminium foil which will properly disperse those unwanted back waves and won't hold water and rot like many other foam alternatives.

- Designed for the absorption of speaker back wave distortion for high quality sound.
- Seal drivers to door trims and spacers to door skins.
- Industry leading 3 layer back wave dispersion pad.
- Multiple size foam rings included to suit most common speaker installation size requirements from 200mm to 45mm.
- Closed cell waterproof foam material, will not absorb water or retain moisture.
- Includes enough material for the installation of a pair of speaker.

PRODUCT CODE  
**57 STPCRPRO**



**STANDARTPLAST SPECIAL LINE MADELINE SELF-ADHESIVE ANTI-SQUEAK TAPE**

StP Madeline Tape is a self-adhesive textile material tape designed to be used in vehicle interiors. It is used to eliminate squeaks in vehicle trims often caused between plastic and metal surface friction.

- Decorative self-adhesive, anti-squeak material.
- Used in cabins, interiors and boot linings.
- Made from high quality textile composition.
- Comes with an adhesive mounting layer.
- Covered with an anti-adhesive film.
- Highly durable materials.
- 1 roll measuring 15mm wide and 2m in length.
- 3mm thickness.
- Made from high quality textile composition.

PRODUCT CODE  
**57 STPMLTPE**

**STANDARTPLAST HEAVY DUTY INSTALLATION ROLLER 30MM**

The tool features a wooden handle with a solid metal 30mm wide roller. The roller ensures proper adhesion of StP products and makes the installation quicker and easier, providing better overall results.

- Heavy duty design with wooden handle.
- 30mm wide metal roller with grooves.
- Helps provide proper adhesion of the product.
- Quicker and easier installation process, with better overall results.

PRODUCT CODE  
**57 STPRL30**



**DR ARTEX 2.6MM GOLD SOUND DEADENING SHEETS 8 PIECE PACK**

Due to its nature, chassis transfers a lot of noise and vibration. Dr ARTEX Advanced product is designed to be flexible and to adhere to any surface. It has highest vibration dampening properties and ensures that chassis does not rust. Improves sound quality inside the car and reduces rattling, road noise and vibrations.

- No bitumen additives provide extra flexibility and tighter adhesion
- No unpleasant smells
- 8 sheets of 75x50cm each.

PRODUCT CODE  
**75 DEE262018**





**AERPRO  
ULTRA COMPACT 2.1A  
USB PORT FOR 12/24V  
CHARGING SOCKET**

This USB car charger relieves you from the nagging worry of your smartphone or tablet switching off. This car charger comes in handy when your smartphone's battery is drained out and you need to quickly recharge while driving.

- Charges smartphone, iPod, digital camera, tablet etc.
- Has handle for easy removal.
- Output USB 2.1 Amp.

PRODUCT CODE  
**50 USBM21**



**AERPRO  
USB TO MICRO USB CABLE  
1.2M BLACK**

Aerpro ADM95B is a USB to Micro USB cable suitable for any phone/tablet with micro USB connection cables that enables sync and charge.

- You can use this cable to charge and sync your smartphone, tablet, camera, MP3 player, GPS unit or other micro USB enabled device
- Supports up to 2A for fast charging of your devices
- 1.2 metre cable length
- Black cable colour

PRODUCT CODE  
**74 ADM95B**



**AERPRO  
STEREO LEAD RIGHT  
ANGLED PLUG  
3.5MM TO 3.5MM 1M**

3.5mm to 3.5mm audio jack stereo lead.

- Right-angled plug one end.

PRODUCT CODE  
**51 AP135**



**AERPRO  
USB CHARGER  
PLUS USB TYPE-C**

2 way charger (normal USB charger with smart IC + quick charger 3.0) and a USB type C connector (auto optimizing 5V/2.4A & 9V/1.5A), with a 1 meter cable.

- USB Type-A Socket with Smart IC and Qualcomm Quick Charge 3.0
- USB Type-C Plug with Auto Optimizing 5V/2.4A & 9V/1.5A Output

PRODUCT CODE  
**74 ADMQC3U**



**AERPRO  
USB 3.0 TO USB  
TYPE-C CABLE 1M**

The Aerpro ADM105C cable can be used to connect devices with a USB-C port to a computer or charger with a USB-A port. The cable can be used to charge devices or sync data from your device to computer.

- Compatible with devices that have Type C connection
- Built for fast data syncing and charging
- Super speed USB 3.0 certified with syncing and data transfer rate of up to 5Gbps
- Reversible Type-C Connector for hassle free use
- 1 metre cable length
- White cable colour

PRODUCT CODE  
**74 ADM105C**



**AERPRO  
FM TRANSMITTER  
4-CHANNEL**

The Aerpro 4 Channel FM transmitter allows you to play your digital audio tracks from MP3 players, iPhones, iPods and smartphones through your car audio system over FM radio.

- Audio frequency range 20Hz - 18KHz.
- Current 100mA max.
- 3.5mm Audio input jack.
- Plugs into cigarette lighter socket.

PRODUCT CODE  
**74 AMPFMT35**



**AERPRO  
FM TRANSMITTER  
WITH USB CHARGER**

Aerpro's Bluetooth and wireless kits enable you to safely use your phone whilst driving, or stream music from your device, to your car stereo.

- Full frequency 87.5 - 108 MHZ. 1000MA output.
- Quick charging 3.5mm audio input jack.
- Overcharge and short circuit protection.
- Plugs into car 12V - 24V socket.
- Blue high definition LCD display.
- Additional USB port charging for other USB devices.
- Play digital audio tracks from MP3 Player, iPhone, iPod, etc. through your car audio system.

PRODUCT CODE  
**74 ADM200TC**



**AERPRO  
VEHICLE CASSETTE  
ADAPTOR**

This product is a cassette tape adaptor that allows music to be played via a headphones jack into the car stereo. Allows any portable CD/MD/MP3 player with built-in headphone jack to be heard through the speakers of your car stereo.

- Low noise cassette adaptor.

PRODUCT CODE  
**74 CA900**



**AERPRO  
BLUETOOTH FM  
TRANSMITTER WITH  
DUAL USB**

The Aerpro APBT200 Bluetooth FM Transmitter with Dual USB allows you to safely and conveniently enjoy hands-free phone calls and wireless audio streaming in your vehicle. It simply plugs into your vehicle's 12V or 24V accessory socket and lets you easily take & receive phone calls and listen to your favourite music via the FM Radio.

- Bluetooth V5.0 advanced wireless technology.
- Hands-free calls & audio streaming via your in-car FM radio.
- 87.5-108 MHz FM transmitter frequencies.
- Dual USB charging ports: 5V/2.1A (shared).
- Reversible USB ports, connect the cable in any direction.
- Music Playback via Bluetooth or USB (up to 32GB).
- AUX Line Out for connection to car stereo (AUX cable included).
- LED display with battery voltage detection.
- Angle adjustable housing for easy viewing.

PRODUCT CODE  
**74 APBT200**



**AERPRO  
FM TRANSMITTER**

Aerpro FMT225 is a full frequency FM transmitter, USB charger & music player. It allows you to play music from your Smartphone through your car stereo via FM radio transmission. It is suitable for smartphones and other portable devices via 3.5mm AUX connection.

- Transmit music from your mobile device, MicroSD card or USB flash drive to your cars FM radio using the FMT225
- Listen to your favourite music from your mobile device via the 3.5mm stereo AUX input
- The 2.0 Amp USB socket allows you to charge your mobile device or play MP3 files directly from a USB flash drive
- The pivoting display gives you over 180 degrees of vertical adjustment
- The FMT225 also includes an infrared remote control and AUX cable

PRODUCT CODE  
**74 FMT225**



**AERPRO  
BLUETOOTH FM  
TRANSMITTER  
WITH QUICK CHARGE USB**

The Aerpro APBT210 Bluetooth FM Transmitter with QC3.0 Quick Charge USB allows you to safely and conveniently enjoy hands-free phone calls and wireless audio streaming in your vehicle. It simply plugs into your vehicle's 12V or 24V accessory socket and lets you easily take & receive phone calls and listen to your favourite music via the FM Radio.

- Bluetooth V5.0 advanced wireless technology.
- Hands-free calls & audio streaming via your in-car FM radio.
- Supports smartphone voice assistant function.
- 87.5-108 MHz FM transmitter frequencies.
- Dual USB charging ports: USB1 5V/1A; USB2: QC3.0.
- Music Playback via Bluetooth, USB or Micro SD (up to 32GB).
- Supports MP3, WMA, WAV, FLAC formats.
- LED display with battery voltage detection.
- Colour changing LED bezel.

PRODUCT CODE  
**74 APBT210**



**AERPRO  
COMPACT BLUETOOTH  
AUDIO & HANDS-FREE KIT  
WITH AUX INPUT**

The ABT510B enables wireless Bluetooth streaming from a smartphone or tablet to any system with an AUX input, including car stereos and home entertainment systems. ABT510B features a rechargeable battery that enables up to 5 hours of playback/talk time.

- Small, compact and easy to use design.
- Bluetooth streaming with up to 5 hours talk time.
- High capacity built in rechargeable battery.
- Micro USB charging cable included.
- AUX pass through allows other devices to be connected via AUX input.
- Stream music and calls from your Bluetooth-compatible smartphones or tablets to any aux input.

PRODUCT CODE  
**51 ABT510B**

## ■ UNIVERSAL

**AERPRO  
STEALTH IN-CAR AERIAL**

High gain amplified AM/FM stealth in car antenna designed for hidden installations.

- Connects to either demister grid, antenna grid (where available) or length of wire for signal reception.
- 12VDC amplifier.
- Cable: 260cm.
- Packed in hang sell, full colour blister.
- Designed for hidden installations.

PRODUCT CODE  
**7 AP170**

**AERPRO  
SHARK FIN  
ROOF MOUNT AERIAL**

This super functional antenna is a replacement part for your original antenna, it can enhance the signal and achieve the purpose of decoration, letting your car look more unique.

- Shark fin amplified roof mount antenna.
- Amplify Gain: AM 5db +/- 3db FM 6db +/- 3db.
- Coaxial cable 75 Ohms.
- Power lead length: 300mm.

PRODUCT CODE  
**7 AP218SF**

**AERPRO  
12V INTERNAL MOUNT WINDSCREEN  
STRIP AERIAL**

High gain amplified AM/FM windscreen antenna.

- High gain amplified AM/FM antenna
- Adhesive strip attaches to inner edge of vehicle's window
- 12VDC amplifier
- dB gain : FM 10-15 dB ; AM 5-10 dB
- Cable: 259cm
- Black wire: 12volt +
- Braid wire: Ground
- Packed in hang sell, full colour blister

PRODUCT CODE  
**7 AP259**

**ANTECH  
ROOF MOUNT WHIP AERIAL**

High quality replacement for your broken or missing roof antenna. This antenna is functional and intended for AM/FM radio signal. Easy to install, for your convenience.

- Length: 410mm.
- Thread diameter: 5mm.
- External thread.

PRODUCT CODE  
**7 FRFW**

**ANTECH  
ROOF MOUNT WHIP AERIAL**

High quality universal replacement for your broken or missing roof antenna. This antenna is functional and intended for AM/FM radio signal. Easy to install, for your convenience.

- Universal replacement aerial whip.
- Replaces both 5mm and 6mm whips.
- Adjustable height 11cm to 27cm.
- Also available in chrome.

PRODUCT CODE  
**7 FRFWBK**

**ANTECH  
RUBBER ROOF MOUNT WHIP AERIAL**

High quality replacement for your broken or missing roof antenna. This antenna is functional and intended for AM/FM radio signal. The antenna is very convenient as it is easy to install.

- Base length: 175mm.
- Thread diameter: 5mm.
- Thread type: External.
- Amplified: No.
- Sections: 1.

PRODUCT CODE  
**7 RUR1M**

## ■ UNIVERSAL (CONTINUED)

**ANTECH  
SILVER COWL MOUNT AERIAL**

This product is a fixed cowl mount fitted to the top of the mudguard. It does not recess into mudguard.

- Extended length: 930mm.
- Number of sections: 3.

PRODUCT CODE  
**7 CM12**

**ANTECH  
SILVER ADJUSTABLE SPRING BASE  
COWL MOUNT AERIAL**

The adjustable cowl mount is fitted to the top of the mudguard. Usually 3 sections, and is permanently extended with a spring at the base which allows the aerial to spring back and forth reducing the chances of breaking when objects are hit.

- Extended length: 1230mm.
- Number of sections: 3.

PRODUCT CODE  
**7 CMAS12**

**ANTECH  
SILVER RETRACTABLE  
COWL MOUNT AERIAL**

The retractable cowl mount is fitted to the top of the mudguard and has four or five sections. This aerial can be manually pushed down away from harms way.

- Extended length: 950mm.
- Number of sections: 5.

PRODUCT CODE  
**7 CMR1**

**ANTECH  
CHROME HIGH ANGLE  
COWL MOUNT AERIAL**

The cowl mounted antennas are fitted to the mudguard and it does not recess into the mudguard.

- Extended length: 970mm.
- Number of sections: 4.

PRODUCT CODE  
**7 VW4100**

**ANTECH  
ADJUSTABLE SPRING BASE  
COWL MOUNT AERIAL**

The adjustable cowl mount is fitted to the top of the mudguard. Usually 3 sections, and is permanently extended with a spring at the base which allows the aerial to spring back and forth reducing the chances of breaking when objects are hit.

- Extended length: 1340mm.
- Number of sections: 3.

PRODUCT CODE  
**7 CMAS13B**

**ANTECH  
RUBBER COWL MOUNT WHIP AERIAL  
WITH ADJUSTABLE BASE**

The cowl mounted antennas are fitted to the mudguard and it does not recess into the mudguard.

- Extended length: 370mm.
- Number of sections: 1.
- Replacement mast available.

PRODUCT CODE  
**7 R400TB**



■ UNIVERSAL (CONTINUED)



**ANTECH RUBBER COWL MOUNT WHIP AERIAL**

The cowl mounted antennas are fitted to the mudguard and it does not recess into the mudguard.

- Extended length: 370mm.
- Number of sections: 1.
- Replacement mast available.

PRODUCT CODE  
**7 RU400**



**AERPRO 3 SECTION SPRING BALL BASE COWL MOUNT ADJUSTABLE BLACK AERIAL**

Adjustable split ball base for 25mm hole.

- Spring base to protect from overhead damage
- 3 section stainless steel mast
- Extends to 100cm
- Cable 137cm
- Packed in hang sell, full colour blister

PRODUCT CODE  
**7 AP42B**



**ANTECH ADJUSTABLE SPRING BASE ROOF MOUNT AERIAL**

This product is a high quality replacement for your broken or missing roof antenna. The aerial is roof mounted and has a spring base.

- Extended length: 720mm.
- Number of sections: 2.

PRODUCT CODE  
**7 ARF24B**



**ANTECH CHROME GUTTER GRIP ADJUSTABLE AERIAL**

This aerial mount can only be fitted to a vehicle that has a gutter ridge on its roof.

- Extended length: 700mm.
- Number of sections: 2.
- Spring base.

PRODUCT CODE  
**7 GG1**



**ANTECH CHROME OFFSET PILLAR MOUNTED AERIAL**

The pillar mounted aerial is perfect if you're looking for an aerial that can be mounted on the pillar on either side of the front windscreen.

- Extended length: 1255mm.
- Number of sections: 3.
- Offset pillar.

PRODUCT CODE  
**7 PM12**



**ANTECH CHROME INLINE PILLAR MOUNTED AERIAL**

The pillar mounted aerial is perfect if you're looking for an aerial that can be mounted on the pillar on either side of the front windscreen.

- Extended length: 1240mm.
- Number of sections: 3.
- Inline pillar.

PRODUCT CODE  
**7 PMCS12**

■ UNIVERSAL (CONTINUED)



**ANTECH CHROME FULLY AUTOMATIC AERIAL**

If you're looking to replace your antenna, this is the product for you. The aerial delivers great range and clarity anywhere the road takes you. The aerial has the durability and capability for achieving superior performance.

- Extended length: 810mm.
- Number of sections: 4.
- Fully automatic.
- Under fender length: 340mm.

PRODUCT CODE  
**7 MZ19**



**ANTECH CHROME FULLY AUTOMATIC AERIAL**

If you're looking to replace your antenna, this is the product for you. The aerial delivers great range and clarity anywhere the road takes you. The aerial has the durability and capability for achieving superior performance.

- Extended length: 945mm.
- Number of sections: 5.
- Fully automatic.
- Under fender length: 315mm.
- Replacement mast available.

PRODUCT CODE  
**7 MZ21**



**ANTECH UNIVERSAL AUTOMATIC AERIAL MAST FOR MZ SERIES**

The mast is 100% identical to the mast you would get from your car dealer, thus there is no universal fit here. If your antenna mast is missing or if the antenna motor still runs, this part will repair your antenna!

- Base length: 239mm.
- Shaft O.D: 9mm.
- Sleeve O.D: 10mm (split).
- Cord length: 1080mm.
- Sections: 5, Toothed: Yes.

PRODUCT CODE  
**7 MZMAST**

■ FORD



**AERPRO 5 SECTION MAST AERIAL TO SUIT FORD FALCON 1994 ON**

These antennas are designed specifically to replace the OEM fit antenna where a universal type is not suitable

- 5 section stainless steel mast
- Top key lockdown
- Extends to 100cm
- Cable: 53cm
- Packed in hang sell, full colour blister

PRODUCT CODE  
**7 AP69**



**ANTECH WHIP AERIAL - FORD KA 1992 TO 2002**

If you're looking to replace your antenna, this is the product for you. The aerial whip delivers great range and clarity anywhere the road takes you. The aerial has the durability and capability for achieving superior performance.

- Extended length: 550mm.
- Number of sections: 1.

PRODUCT CODE  
**7 AP195**

■ HOLDEN



**AERPRO**  
5 SECTION MAST AERIAL TO SUIT  
HOLDEN COMMODORE VN-VT 88-00

These antennas are designed specifically to replace the OEM fit antenna where a universal type is not suitable.

- 5 section stainless steel mast
- Extends to 99cm
- Cable: 50cm
- Replacement mast: AP12

PRODUCT CODE  
**7 AP6**



**AERPRO**  
GUARD MOUNT MAST AERIAL TO SUIT  
HOLDEN COMMODORE VN-VT 88-00

These antennas are designed specifically to replace the OEM fit antenna where a universal type is not suitable

- Guard mount
- Top key push down Antenna
- 5 section stainless steel mast
- Extends to 97cm
- Cable 42cm
- Packed in hang sell, full colour blister

PRODUCT CODE  
**7 AP70**



**AERPRO**  
5 SECTION MAST AERIAL TO SUIT  
HOLDEN COMMODORE VT-VZ 1997 ON

These antennas are designed specifically to replace the OEM fit antenna where a universal type is not suitable. Replace the faulty or damaged power antenna in your vehicle with this fully automatic power antenna.

- Extended length: 990mm.
- Number of sections: 5.
- Fully automatic.
- Replacement mast available.

PRODUCT CODE  
**7 AP971**



**ANTECH**  
AERIAL MAST - HOLDEN  
COMMODORE VN-VY

The mast is 100% identical to the mast you would get from your car dealer, thus there is no universal fit here. If your antenna mast is missing or if the antenna motor still runs, this part will repair your antenna!

- Base length: 260mm.
- Shaft O.D: 8.5mm.
- Sleeve O.D: 11mm.
- Cord Length: 1065mm.
- Sections: 5, Toothed: Yes.

PRODUCT CODE  
**7 VNMAST**



**ANTECH**  
AERIAL MAST - HOLDEN  
COMMODORE VY2 2004 ONWARDS

The mast is 100% identical to the mast you would get from your car dealer, thus there is no universal fit here. If your antenna mast is missing or if the antenna motor still runs, this part will repair your antenna!

- Base length: 252mm.
- Shaft O.D: 9mm.
- Sleeve O.D: No.
- Cord Length: 1120mm.
- Sections: 5, Toothed: Yes.

PRODUCT CODE  
**7 VY2MAST**



**AERPRO**  
PILLAR MOUNTED AERIAL TO SUIT  
2008 HOLDEN COLORADO

Pillar Mount Antenna to suit 2008 Colorado LX 4X2 DX 4X4 Single Cab and LX 4X4 Crew Cab.

- 2 Section Mast extended length 92.5cm
- Cable length: 125 cm
- Mounting hole spacing: 74mm

PRODUCT CODE  
**7 AP136**

■ MITSUBISHI



**ANTECH**  
AERIAL MITSUBISHI  
L-300 1992 ON

If you're looking to replace your antenna, this is the product for you. The aerial delivers great range and clarity anywhere the road takes you. The aerial has the durability and capability for achieving superior performance.

- Extended length: 990mm.
- Number of sections: 2.

PRODUCT CODE  
**7 MTB017**



**AERPRO**  
MAST AERIAL TO SUIT MITSUBISHI  
PAJERO MAGNA GALANT

Car antenna to suit Mitsubishi Magna TE-TW 96-05, Pajero NA-NL 83-99, Galant (Non Pillar mount models).

- 5 section stainless steel mast
- Extends to 93cm
- Mast diameter: 10mm
- Retracted length: 250mm
- Sleeve diameter: 11mm
- Sleeve length: 61mm
- Nylon bush diameter: 11.5mm

PRODUCT CODE  
**7 AP253**



**ANTECH**  
ADJUSTABLE AERIAL MITSUBISHI  
PAJERO 1984-99

If you're looking to replace your antenna, this is the product for you. The aerial delivers great range and clarity anywhere the road takes you. The aerial has the durability and capability for achieving superior performance.

- Extended length: 870mm.
- Number of sections: 4.

PRODUCT CODE  
**7 AP78**

■ NISSAN



**ANTECH**  
AERIAL MAST - NISSAN  
BLUEBIRD 1992 ONWARDS

The mast is 100% identical to the mast you would get from your car dealer, thus there is no universal fit here. If your antenna mast is missing or if the antenna motor still runs, this part will repair your antenna!

- Base length: 218mm.
- Shaft O.D: 9mm.
- Sleeve O.D: No.
- Cord length: 1075mm.
- Sections: 5, Toothed: Yes.

PRODUCT CODE  
**7 NB2MAST**



**AERPRO**  
4 SECTION MAST AERIAL TO SUIT  
NAVARA 92-97 & PATHFINDER 88-95

These antennas are designed specifically to replace the OEM fit antenna where a universal type is not suitable.

- 4 section stainless steel mast
- Extends to 94cm
- Cable: 69cm
- Packed in hang sell, full colour blister

PRODUCT CODE  
**7 AP81**

■ SUZUKI



**AERPRO**  
PILLAR MOUNTED AERIAL TO SUIT  
SWIFT 1989 TO 1994

These antennas are designed specifically to replace the OEM fit antenna where a universal type is not suitable.

- 2 section stainless steel mast
- Extends to 97cm
- Cable: 245cm
- Mounting hole spacing: 76mm
- Packed in hang sell, full colour blister

PRODUCT CODE  
**7 AP149**

■ TOYOTA



**AERPRO**  
**MAST AERIAL TO SUIT**  
**HILUX 1989-1997 & RODEO 1988-2003**

These antennas are designed specifically to replace the OEM fit antenna where a universal type is not suitable.

- Pushdown antenna
- 4 section stainless steel mast
- Extends to 90cm
- Cable: 124cm
- Packed in hang sell, full colour blister

PRODUCT CODE  
**7 AP77**



**ANTECH**  
**AERIAL MAST - TOYOTA**  
**HILUX 1998 ONWARDS**

If you're looking to replace your antenna, this is the product for you. The aerial delivers great range and clarity anywhere the road takes you. The aerial has the durability and capability for achieving superior performance.

- Extended length: 965mm.
- Number of sections: 4.

PRODUCT CODE  
**7 TH98**



**ANTECH**  
**AERIAL MAST - TOYOTA**  
**HILUX-SURF 1984 ONWARDS**

The mast is 100% identical to the mast you would get from your car dealer, thus there is no universal fit here. If your antenna mast is missing or if the antenna motor still runs, this part will repair your antenna!

- Base length: 215mm.
- Shaft O.D: 8mm.
- Sleeve O.D: 10mm.
- Cord length: 1100mm.
- Sections: 5, Toothed: Yes.

PRODUCT CODE  
**7 THMAST**



**AERPRO**  
**MAST AERIAL TO SUIT TOYOTA**  
**LANDCRUISER 1999-2006**

Replacement antenna mast and rope to suit Toyota Landcruiser: 78 Series (Troop Carrier) 79 Series 100 Series

- 5 section stainless steel mast
- Extends to 85 cm
- Mast diameter: 9 mm
- Retracted length: 280 mm
- Sleeve diameter: 10mm
- Sleeve length: 70 mm

PRODUCT CODE  
**7 AP266**



**AERPRO**  
**4 SECTION MAST AERIAL TO SUIT**  
**LANDCRUISER 1990-1998**

These antennas are designed specifically to replace the OEM fit antenna where a universal type is not suitable.

- 4 section stainless steel mast
- Extends to 97cm
- Cable: 126cm
- Packed in hang sell, full colour blister

PRODUCT CODE  
**7 AP73**



**ANTECH**  
**AERIAL MAST - TOYOTA**  
**PRADO 1996 ONWARDS**

The mast is 100% identical to the mast you would get from your car dealer, thus there is no universal fit here. If your antenna mast is missing or if the antenna motor still runs, this part will repair your antenna!

- Base length: 249mm.
- Shaft O.D: 8.5mm.
- Sleeve O.D: 10mm.
- Cord length: 1100mm.
- Sections: 5, Toothed: Yes.

PRODUCT CODE  
**7 TP96MAST**

■ UNIVERSAL



**AERPRO**  
**600MM ANTENNA EXTENSION LEAD**

60cm antenna extension lead for use when lead on antenna will not reach the radio.

PRODUCT CODE  
**7 AP340**



**AERPRO**  
**1 METRE EXTENSION LEAD**

1m antenna extension cable for use when lead on antenna won't reach the radio.

PRODUCT CODE  
**7 AP334**



**ANTECH**  
**STANDARD AERIAL EXTENSION LEAD**

This extension cable is specifically designed to provide sharp and clear signal for your car radio system.

PRODUCT CODE  
**7 EXT1200 1000MM**  
**7 EXT3000 3000MM**



**AERPRO**  
**3 METRE ANTENNA EXTENSION LEAD**

3m antenna extension cable for use when the lead on antenna won't reach the radio.

PRODUCT CODE  
**7 AP336**



**AERPRO**  
**5 METRE EXTENSION LEAD**

5m antenna extension lead for use when lead on antenna won't reach the radio.

PRODUCT CODE  
**7 AP337**



**AERPRO**  
**200MM 90DEG EXTENSION CABLE**

This 20cm long extension cable with right-angled plug makes for easy installation where there is limited space behind the radio.

PRODUCT CODE  
**7 AP332**



**AERPRO**  
**AM/FM AERIAL SCREW-IN PLUG**

This product is a screw type antenna plug to replace an original plug on the antenna cable.

- Screw type antenna plug to replace original plug on antenna cable.
- A last resort if you cannot find an adaptor.

PRODUCT CODE  
**7 AP333**



**AERPRO**  
**2-IN-1 AERIAL SPLITTER**  
**ADAPTOR CABLE**

The antenna splitter allows two antennas to be connected to your car stereo.

- Fitted with two female sockets and one plug
- Packed in hang sell, full colour blister

PRODUCT CODE  
**7 AP339**

■ EUROPEAN



**AERPRO**  
**AERIAL ADAPTOR EUROPEAN TO AFTERMARKET**

This adaptor converts a factory headunit antenna connection to a standard DIN socket for aftermarket antennas. This adaptor connects an aftermarket antenna to a European radio.

- Adapts European OEM radio to standard antenna socket.
- Suited for usually pre 2003 European cars.

PRODUCT CODE  
**7 AP346**



**AERPRO**  
**HEADUNIT AERIAL ADAPTOR LEAD AMPLIFIED EUROPEAN**

This product converts a factory headunit antenna connection to a standard DIN plug for aftermarket head units.

- Amplifies the received FM signal.
- Ideal for in-window antennas, hard-to-tune station.
- Connects Euro antenna and aftermarket radio.
- Requires 12V DC negative ground.

PRODUCT CODE  
**7 AP3421**



**AERPRO**  
**ANTENNA ADAPTOR FOR EUROPEAN CARS**

This adaptor allows an aftermarket antenna to fit a European radio. It is 20cm long.

PRODUCT CODE  
**7 AP344**

■ NISSAN



**ANTECH**  
**STANDARD SOCKET TO NISSAN 2 PIN SOCKET ADAPTER**

This extension cable is specifically designed to provide sharp and clear signal for your car radio system.

- Input: Standard male plug.
- Output: Nissan 2-pin socket.
- Length: 290mm.

PRODUCT CODE  
**7 EXT300N1**



**AERPRO**  
**NISSAN DIVERSITY ADAPTOR-AFTERMARKET RADIO TO FACTORY AERIAL**

Nissan Diversity Adaptor - Aftermarket Radio to Factory Antenna. Used to connect an aftermarket radio socket to a factory Nissan double-diversity antenna plug.

- Used to connect an aftermarket radio socket to a factory.
- Converts a factory headunit antenna connection to a standard DIN plug for aftermarket headunits.

PRODUCT CODE  
**7 AP348A**



**AERPRO**  
**STANDARD PLUG SOCKET TO NISSAN 2 PIN PLUG ADAPTER**

Used to connect an aftermarket antenna to a factory Nissan double-diversity amplifier.

PRODUCT CODE  
**7 AP348B**

■ MULTI-FITMENT



**AERPRO**  
**HEADUNIT AERIAL ADAPTOR EUROPEAN FEMALE TO AFTERMARKET**

This adaptor converts a factory headunit antenna connection to a standard DIN socket for aftermarket antennas. This adaptor allows you to fit an aftermarket radio into a vehicle with a European antenna.

- Adapts European car aerial to standard ISO antenna plug.
- Referred to as European connector.

PRODUCT CODE  
**7 AP349**



**AERPRO**  
**HEADUNIT AERIAL ADAPTOR ISO CAR TO MALE DIN WITH LEAD**

Our multi-fit range comes with various functions to suit your needs and fit cars that do not require a custom fit type antenna. This adaptor converts a factory headunit antenna connection to a standard DIN socket for aftermarket antennas.

- Antenna adaptor: ISO car to male DIN with lead.

PRODUCT CODE  
**7 AP349L**



**AERPRO**  
**FM ANTENNA BOOSTER 12V AMPLIFIED 10DB**

This antenna booster will obtain clearer and stronger reception in fringe reception areas. It provides a 10dB gain over the FM spectrum. In-dash or under dash mounting, fitted with 53cm antenna cable and power cable.

- 10dB gain.
- In-dash or under dash mounting.
- Fitted with 53cm antenna cable and power cable.

PRODUCT CODE  
**7 AP342**



**ANTECH**  
**12V 14 MHZ SHIFT BAND EXPANDER**

For some import vehicles, radios are made to receive frequencies between 76Mhz to 90Mhz but in other countries you need as much as 108Mhz. The electronic FM band expander expands the range of car radio up to 108 Mhz.

- Frequency shift: 14MHz.
- Frequency input: 76-90MHz.
- Frequency output: 88-108MHz.
- Voltage: 12V.

PRODUCT CODE  
**7 FA14**

■ AUDI



**AERPRO HEADUNIT AERIAL ADAPTOR LEAD AUDI 02 ON AMPLIFIED**

Converts a factory headunit antenna connection to a standard DIN plug for aftermarket head units.

- Antenna adaptor DIN with Fakra and phantom power supply.

PRODUCT CODE  
**7 APA59**



**AERPRO HEADUNIT AERIAL ADAPTOR LEAD AUDI 02 ON DIVERSITY**

Converts a factory headunit antenna connection to a standard DIN plug for aftermarket head units. Some vehicles are fitted with a specific style of antenna plug, this can make upgrading to an aftermarket headunit a bit tricky.

- For cars with 2 Fakra antenna connectors.
- Use with antenna w/ inbuilt mast head amplifier.
- Retains diversity tuning.

PRODUCT CODE  
**7 APA60**



**AERPRO HEADUNIT AERIAL ADAPTOR LEAD EURO 2002 ON**

Converts a factory headunit antenna connection to a standard DIN plug for aftermarket head units. Some vehicles are fitted with a specific style of antenna plug, this can make upgrading to an aftermarket headunit a bit tricky.

- For cars with Fakra antenna connector.
- Antenna may be passive or active with separate mast head amplifier trigger.

PRODUCT CODE  
**7 APA58**

■ EUROPEAN



**AERPRO HEADUNIT AERIAL ADAPTOR LEAD MULTI-FIT EUROPEAN**

Converts a factory headunit antenna connection to a standard DIN plug for aftermarket headunits.

- Suited for: Audi, Mercedes Benz, Seat, Skoda, Volkswagen

PRODUCT CODE  
**7 APA66**



**AERPRO HEADUNIT AERIAL ADAPTOR LEAD ON EUROPEAN 2001**

Converts a factory headunit antenna connection to a standard DIN socket for aftermarket antennas.

- For cars with OEM radio.
- Converts Ant input to standard DIN socket.

PRODUCT CODE  
**7 APA67**

■ FAKRA



**AERPRO HEADUNIT AERIAL ADAPTOR PLUG FAKRA TO DIN**

Converts a factory headunit antenna connection to a standard DIN plug for aftermarket head units. Antenna adaptor plug for cars fitted with Fakra antenna connector (of any coding).

- For cars with Fakra antenna connector.

PRODUCT CODE  
**7 APA68**



**AERPRO AERIAL ADAPTOR DOUBLE FAKRA TO M DIN PHANTOM POWER 12V**

Converts a factory headunit antenna connection to a standard DIN plug for aftermarket headunits.

- Antenna adaptor lead for cars fitted with dual Fakra antenna connectors and an antenna system that has an inbuilt mast head amplifier system.
- Does not retain diversity tuning, combines antenna signal into one signal.

PRODUCT CODE  
**7 APA70**

■ CHEVROLET/HONDA



**AERPRO HEADUNIT ANTENNA ADAPTER TO CHEVROLET/HONDA**

Mini socket to standard antenna to suit: Chevrolet Corvette 1997-2002, Chevrolet Corvette 2005-2013, Hummer H2 2003-2008 & Hummer H3 2007-2009.

PRODUCT CODE  
**7 APA74**

■ HONDA



**AERPRO HEADUNIT AERIAL ADAPTOR LEAD TO SUIT HONDA**

Aerpro antenna adapters simply plug into the vehicles specific antenna plug and convert it to a standard plug (DIN) which is suitable for most aftermarket head units.

- For cars with OEM Honda nylon block connector.
- Found in: Jazz, Insight.

PRODUCT CODE  
**7 APA79**



**AERPRO HEADUNIT AERIAL ADAPTOR LEAD - MALE HONDA**

Converts a factory headunit antenna connection to a standard DIN plug for aftermarket head units.

- For cars with OEM Hyundai/Kia nylon connector.
- Found in: Accord, Civic, CRV, Odyssey.

PRODUCT CODE  
**7 APA55**



**AERPRO HEADUNIT AERIAL ADAPTOR LEAD - FEMALE HONDA**

Converts a factory headunit antenna connection to a standard DIN plug for aftermarket head units.

- For cars with OEM radio.
- Converts Ant input to standard DIN socket
- Found in: Civic, CRV.

PRODUCT CODE  
**7 APA56**

■ HYUNDAI/KIA



**AERPRO HEADUNIT AERIAL ADAPTOR LEAD SUITS HYUNDAI & KIA**

Converts a factory headunit antenna connection to a standard DIN plug for aftermarket head units. Some vehicles are fitted with a specific style of antenna plug, this can make upgrading to an aftermarket headunit a bit tricky.

- For cars with OEM Hyundai/Kia nylon connector.
- To suit Hyundai i10/i30 2007-2010, i40 2011 onwards and Kia Cerato.

PRODUCT CODE  
**7 APA47**



**AERPRO HEADUNIT AERIAL ADAPTOR LEAD SUITS HYUNDAI & KIA 2009 ON**

Converts a factory headunit antenna connection to a standard DIN plug for aftermarket head units. The product is a radio antenna adapter to suit aftermarket radio.

- For cars with OEM Hyundai/Kia nylon connector.
- Found in: Accent, Optima.

PRODUCT CODE  
**7 APA63**



**AERPRO HEADUNIT AERIAL ADAPTOR LEAD SUITS SELECTED HYUNDAI & KIA**

Converts a factory headunit antenna connection to a standard DIN socket for aftermarket antennas.

- To suit: Hyundai i30 07 onwards, Kia Soul 09 onwards
- Hyundai / Kia Male to DIN Female

PRODUCT CODE  
**7 APA64**

■ CHRYSLER/JEEP



**AERPRO HEADUNIT AERIAL ADAPTOR LEAD CHRYSLER JEEP 2002 ON**

Converts a factory headunit antenna connection to a standard DIN plug for aftermarket head units. Some vehicles are fitted with a specific style of antenna plug, this can make upgrading to an aftermarket headunit a bit tricky.

- For cars with Chrysler/Jeep 2002 on socket.

PRODUCT CODE  
**7 APA36**

■ NISSAN



**AERPRO HEADUNIT AERIAL ADAPTOR LEAD NISSAN**

The product is a Nissan antenna adapter cable that enables universal head unit to be used in Nissan vehicle. Converts a factory headunit antenna connection to a standard DIN plug for aftermarket head units.

- Enables universal head unit to work in a Nissan.

PRODUCT CODE  
**7 APA69**



**AERPRO FACTORY RADIO AERIAL ADAPTOR LEAD SUIT OEM NISSAN**

Converts a factory headunit antenna connection to a standard DIN socket for aftermarket antennas. The product is used when installing aftermarket antenna to factory radio.

- Antenna adaptor lead to suit OEM Nissan.

PRODUCT CODE  
**7 APA89**

■ SUBARU



**AERPRO HEADUNIT AERIAL ADAPTOR LEAD SUBARU**

Converts a factory headunit antenna connection to a standard DIN plug for aftermarket head units. The adaptor is ideal to convert Subaru factory antenna plug to aftermarket radio.

- For cars with OEM Subaru nylon block connector.
- Found in: late model Subarus.

PRODUCT CODE  
**7 APA52**



**AERPRO FACTORY RADIO AERIAL ADAPTOR SUBARU**

Converts a factory headunit antenna connection to a standard DIN plug for aftermarket head units.

- For cars with OEM radio.
- Converts Ant input to standard DIN socket.
- Found in late model Subarus.

PRODUCT CODE  
**7 APA53**

■ SUBARU/TOYOTA



**AERPRO HEADUNIT AERIAL ADAPTOR LEAD SUITS SELECTED TOYOTA & SUBARU**

Aerpro antenna adapters simply plug into the vehicles specific antenna plug and convert it to a standard plug (DIN) which is suitable for most aftermarket head units.

- For cars with OEM Toyota nylon block connector.
- Found in: Late Toyota models.

PRODUCT CODE  
**7 APA75**

■ TOYOTA



**AERPRO FACTORY RADIO AERIAL ADAPTOR LEAD SUIT TOYOTA**

Converts a factory headunit antenna connection to a standard DIN socket for aftermarket antennas. Converts female DIN antenna socket to male Toyota antenna plug. Designed for adding an aftermarket antenna to a factory-fitted headunit

- For cars with OEM radio.
- Converts antenna input to female DIN socket.

PRODUCT CODE  
**7 APA81**

■ VOLVO



**AERPRO HEADUNIT AERIAL ADAPTOR LEAD SUIT VOLVO**

Converts a factory headunit antenna connection to a standard DIN plug for aftermarket head units.

- For cars with OEM Volvo nylon block connector.
- Found in: S80, V70, V40.

PRODUCT CODE  
**7 APA85**

# Aerpro<sup>®</sup>

First Choice

## CB UHF AERIALS & BRACKETS



**AERPRO**  
**15CM UHF CD WHIP AERIAL 477 MHZ 3DBI**

UHF CB Radio antennas are all now made with 100% stainless steel spring and body construction making them suitable for all the harsh conditions that the environment can throw at them.

- UHF CB whip antenna.
- Frequency: 477MHZ.
- Length: 15cm.
- Gain: 3 DBI.

PRODUCT CODE  
**7 CBA15**



**AERPRO**  
**16CM ENCLOSED UHF AERIAL IN FIBREGLASS TUBE 477 MHZ 4.5DBI**

The new UHF CB radio antennas are all now made with 100% stainless steel spring and body construction making them suitable for all the harsh conditions that the environment can throw at them.

- Heavy duty spring base.
- Enclosed antenna in PVC tube.
- Gain: 4.5 dBi.
- Frequency: 477MHZ.

PRODUCT CODE  
**7 CBA2T1**



**AERPRO**  
**CB AERIAL GUTTER MOUNT BRACKET**

The CB antenna gutter mount bracket allows for quick-release mounting of both CB and AM/FM antennas.

- Gutter mountable.

PRODUCT CODE  
**7 CBA36**



**AERPRO**  
**UHF AERIAL WITH ELEVATED FEED & SPRING BASE 3DBI 6DBI 477 MHZ**

The Aerpro UHF antenna kit features a high-quality elevated feed and heavy-duty spring base combined with interchangeable 3dBi and 6dBi flexible masts giving the best of both worlds when it comes to UHF reception.

- Heavy duty spring base.
- Fitted with 5 metres of RG58 coax cable.
- 65CM Whip (6DBI).
- 15CM Whip (3DBI).
- 477 MHz.

PRODUCT CODE  
**7 CBA36F1L**



**AERPRO**  
**60CM UHF FIBREGLASS WHIP AERIAL 477 MHZ 4.5DBI**

UHF CB radio antennas are all now made with 100% stainless steel spring and body construction making them suitable for all the harsh conditions that the environment can throw at them.

- Frequency: 477MHZ
- Length: 2ft (60cm)
- Gain: 4.5 dBi
- 1/4in thread.

PRODUCT CODE  
**7 CBA3F1**



**AERPRO**  
**UHF AERIAL WITH ELEVATED FEED & SPRING BASE 6DBI 477 MHZ**

UHF CB radio antennas are all now made with 100% stainless steel spring and body construction making them suitable for all the harsh conditions that the environment can throw at them.

- Frequency: 477MHZ.
- Total gain: 6 dBi
- Mast length: 65cm (6dBi)
- Fitted with 5 metres of RG58 coax cable.
- Heavy duty spring base.

PRODUCT CODE  
**7 CBA3F1L**



**AERPRO**  
**91CM CB FIBREGLASS WHIP AERIAL**  
**PRE-TUNED 27 MHZ**

UHF CB radio antennas are all now made with 100% stainless steel spring and body construction making them suitable for all the harsh conditions that the environment can throw at them.

- Pre-tuned.
- Frequency: 27 Mhz.
- Length: 3 Ft (91cm).

PRODUCT CODE  
**7 CBA3FX**



**AERPRO**  
**67CM UHF CB COIL LOADED WHIP**  
**BLACK STEEL AERIAL 4.5DBI 477 MHZ**

UHF CB Radio antennas are all now made with 100% stainless steel spring and body construction making them suitable for all the harsh conditions that the environment can throw at them.

- Frequency: 477MHZ.
- Length: 2ft (67cm).
- Gain: 4.5 dBi.
- 1/4in thread.
- Stainless steel coil loaded whip.

PRODUCT CODE  
**7 CBA4S1**



**AERPRO**  
**106CM ENCLOSED UHF AERIAL IN**  
**FIBREGLASS TUBE 477 MHZ 7.5DBI**

UHF CB radio antennas are all now made with 100% stainless steel spring and body construction making them suitable for all the harsh conditions that the environment can throw at them.

- Frequency: 477MHZ.
- Heavy duty spring base.
- Enclosed antenna in PVC tube.
- Gain: 7.5 DBI.

PRODUCT CODE  
**7 CBA5T1**



**AERPRO**  
**UHF CB ELEVATED FEED AERIAL KIT**  
**BLACK**

UHF CB Radio antennas are all now made with 100% Stainless steel Spring and body construction making them suitable for all the harsh conditions that the environment can throw at them.

- UHF CB Elevated Feed Antenna Kit Black

PRODUCT CODE  
**7 CBB3F1L**



**AERPRO**  
**ANTENNA BRACKET BULL BAR**  
**MOUNT**

Horizontal and vertical mirror mount CB antenna extruded alloy type bracket.

- Horizontal and vertical mounting.
- 28mm (between mounting holes).

PRODUCT CODE  
**7 CBBB3**



**AERPRO**  
**4 POSITION BLACK**  
**UHF ANTENNA BRACKET**

The Aerpro CBBF1B folding bracket provides the ability to easily re-position long UHF CB or Mobile Phone antennas at varying angles. The bracket can be folded into one of four positions and is held securely with a solid spring loaded locking pin.

- Designed to suit UHF CB Antennas.
- Made from T304 stainless steel.
- Electroplated black finish.
- Four positions.
- 16mm standard size mounting stud.
- Easy flip latch for quick re-positioning.
- Hidden cable channel through the base.
- 22mm custom wrench included.
- Designed and engineered in Australia.

PRODUCT CODE  
**7 CBBF1B**



**AERPRO**  
**5M CB UHF AERIAL**  
**BASE & LEAD**  
**PL259 CONNECTOR**  
**SUITS 447 27 MHZ**

This product from Aerpro is a base and lead to suit CB antennas.

- RG58 coax with copper shield cable.
- PL259 connector attached.
- Suits 477 Mhz UHF & 27Mhz.
- 5 metres.

PRODUCT CODE  
**7 CBBL1**



**AERPRO**  
**5M CB UHF AERIAL**  
**BASE & LEAD**  
**FME CONNECTOR**  
**SUITS 447 27 MHZ**

This product from Aerpro is a base and lead to suit CB antennas.

- RG58 coax with copper shield cable.
- Separate FME to PL259 type.
- FME connector attached.
- Suits 477 Mhz UHF & 27Mhz.
- 5 metres.

PRODUCT CODE  
**7 CBBL2**



**AERPRO**  
**CB AERIAL**  
**GUARD MOUNT BRACKET ANGLED**  
**UNIVERSAL**

This product from Aerpro is a universal angled guard mount bracket for CB antennas.

- Angled universal mount.
- Stainless steel.

PRODUCT CODE  
**7 CBBU1**



**AERPRO**  
**CB AERIAL**  
**GUARD MOUNT BRACKET UNIVERSAL**

This product from Aerpro is a universal fitment guard mount bracket for CB antennas.

- Universal fitment.
- Stainless steel.

PRODUCT CODE  
**7 CBBU2**



**AERPRO**  
**CB AERIAL**  
**GUARD MOUNT BRACKET SIDE BOLT**

This product from Aerpro is a side bolt guard mount CB antenna bracket.

- Side bolt type.
- Stainless steel.

PRODUCT CODE  
**7 CBBV2**



**AERPRO**  
**CB MICROPHONE CLIP SCREW TYPE**

- CB microphone clip.
- Screw in type.

PRODUCT CODE  
**7 CBMC**





■ BMW

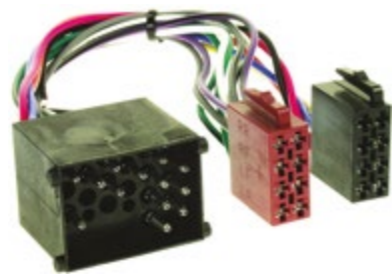

**AERPRO  
HARNESS ISO TO BMW ROUND PIN**

The primary harness is the harness that plugs into your car's main entertainment system connector and converts it into a double ISO connector system (universal).

- ISO connector to suit most BMW models with round pin plug type.
- Suits: BMW 3 series E36/E46 - 01/2005, BMW 5 E39 - 07/2000, BMW 7 E38 - 08/2000, BMW 8 - 08/2000, BMW Mini - 09/2000 - 12/2002, BMW X5 - 2001, BMW Z3/Z4 - 01/1996-04/2001.

PRODUCT CODE  
**71 APP021**



**AERPRO  
HARNESS ISO TO BMW SQUARE PIN**

The primary harness is the harness that plugs into your car's main entertainment system connector and converts it into a double ISO connector system (universal).

- ISO connector to suit most BMW models with square pin plug type.
- Suits: BMW 1 er E87, BMW 3 er E90 - 01/2001, BMW 5 er E39+E60+E61 - 07/2000, BMW 6 er E63+E64, BMW X3/X5/Z4/Z8 - 05/2001.

PRODUCT CODE  
**71 APP022**

■ CHRYSLER/JEEP



**AERPRO  
HARNESS ISO  
TO CHRYSLER-JEEP**

ISO harnesses make upgrading a vehicles headunit a simple task by converting the OEM radio plug to ISO connectors. A brand specific secondary ISO harness (sold separately) can then be used to convert the ISO connectors to suit the aftermarket headunit.

- Easy plug and play solution.
- Converts vehicles radio plug to ISO connectors.
- Suits: Chrysler 300 M 02 - on, Chrysler Grand Voyager RG 02- on, Chrysler PT Cruiser 01 - on, Jeep Cherokee 02 - on, Jeep Wrangler 03 -on.

PRODUCT CODE  
**71 APP019**

■ FORD



**AERPRO  
ADAPTOR LEAD FORD  
TERRITORY BA-BF**

Connect directly from your device's audio outlet using these "AUX" input adaptor harnesses that wire directly into on your car stereo system.

- Allows MP3/iPod/CD to connect to factory radio.
- Ford 5 pin plug to 2 RCA sockets.
- Includes 3.5mm stereo to 2 male RCA plug lead.
- Connect to orange auxiliary socket.

PRODUCT CODE  
**71 AFD2AUX**



**AERPRO  
HARNESS ISO TO FALCON EF-EL**

The primary harness is the harness that plugs into your car's main entertainment system connector and converts it into a double ISO connector system (universal).

- ISO Connector to suit Ford Falcon EF-EL & various Mazda models.

PRODUCT CODE  
**71 APP051**



**AERPRO  
HARNESS ISOTO FALCON AU**

The primary harness is the harness that plugs into your car's main entertainment system connector and converts it into a double ISO connector system (universal).

- Suits: Falcon AU.
- ISO connector.

PRODUCT CODE  
**71 APP053**

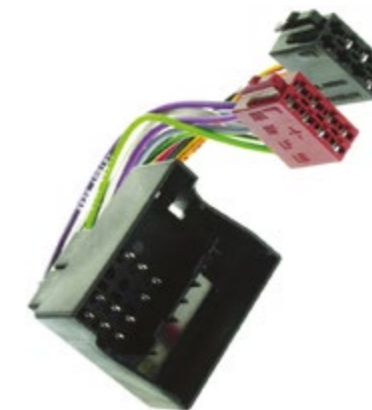

**AERPRO  
HARNESS ISO TO FORD 03-06**

ISO harnesses make upgrading a vehicles headunit a simple task by converting the OEM radio plug to ISO connectors. A brand specific secondary ISO harness (sold separately) can then be used to convert the ISO connectors to suit the aftermarket headunit.

- Easy plug and play solution.
- Converts vehicles radio plug to ISO connectors.
- ISO connector.
- Suits: Fiesta - 06/2005, Focus - 01/2005, Mondeo - 06/2003, Transit - 01/2006.

PRODUCT CODE  
**71 APP055**



**AERPRO  
HARNESS ISO TO FORD 2000 ON**

The primary harness is the harness that plugs into your car's main entertainment system connector and converts it into a double ISO connector system (universal).

- Suits: Cougar 98-on, Explorer 2001-2005, Focus 2002-2004, KA 99-on, Mondeo 2000-on, Transit 2000-2006.
- ISO connector.

PRODUCT CODE  
**71 APP056**

AUDIO 78

AUDIO 79



**WHAT FITS  
YOUR CAR?**

Scan here



AUDIO 80



**WHAT FITS YOUR CAR?**

■ HOLDEN



**AERPRO HARNESS ISO TO ASTRA-VECTRA 1988**

The primary harness is the harness that plugs into your car's main entertainment system connector and converts it into a double ISO connector system (universal).

- Suits: Holden Astra/Vectra 88-on and Commodore VY-VZ.
- ISO connector.

PRODUCT CODE  
**71 APP064**



**AERPRO HARNESS ISO TO COMMODORE VT**

The primary harness is the harness that plugs into your car's main entertainment system connector and converts it into a double ISO connector system (universal).

- Suits: Holden Commodore VT/VX/VU UTE.
- ISO connector.

PRODUCT CODE  
**71 APP062**



**AERPRO HARNESS ISO TO RODEO 2003-06**

The primary harness is the harness that plugs into your car's main entertainment system connector and converts it into a double ISO connector system (universal).

- Suits: Holden Commodore 2003-2006.
- ISO connector.

PRODUCT CODE  
**71 APP063**



**AERPRO CONTROL HARNESS C FOR HOLDEN VY-VZ**

This Aerpro control harness allows you to upgrade to an aftermarket head unit whilst maintaining use of your factory steering wheel controls.

- Steering wheel control, use with aftermarket radio.
- Requires type C patch lead.
- Plug and play.
- Retains the factory steering wheel controls.

PRODUCT CODE  
**71 CHVYVZC**

■ HONDA



**AERPRO HARNESS ISO TO HONDA 1986 ON**

The primary harness is the harness that plugs into your car's main entertainment system connector and converts it into a double ISO connector system (universal).

- Suits: Most Hondas '86-up.
- ISO connector.

PRODUCT CODE  
**71 APP070**



**AERPRO HARNESS ISO TO HONDA 1999 ON**

The primary harness is the harness that plugs into your car's main entertainment system connector and converts it into a double ISO connector system (universal).

- Suits: most Honda and Suzuki models '99-on.
- Converts vehicle specific plug to universal ISO connector system.
- Secure Clips on ISO connectors to ensure secure and long lasting connection
- Provides a Plug & Play installation solution for aftermarket headunits when paired with an Aerpro APP8 Secondary Harness (some hard-wiring may still be required)

PRODUCT CODE  
**71 APP071**



**AERPRO HARNESS ISO TO HONDA 2006 ON**

The primary harness is the harness that plugs into your car's main entertainment system connector and converts it into a double ISO connector system (universal).

- Suits: Civic 06 - on and CRV 06 -on.
- ISO connector.

PRODUCT CODE  
**71 APP076**



**AERPRO HARNESS ISO TO SUIT HONDA**

The primary harness is the harness that plugs into your car's main entertainment system connector and converts it into a double ISO connector system (universal).

- Suits: Jazz 09 -on, Accord 08 -on, Insight 2010 - on.

PRODUCT CODE  
**71 APP077**

AUDIO 81

■ HYUNDAI/KIA



**AERPRO HARNESS ISO TO HYUNDAI 2000 ON**

The primary harness is the harness that plugs into your car's main entertainment system connector and converts it into a double ISO connector system (universal).

- Suits: Most Hyundai 2000-up and also suits Kia Carnival 2003-2005.
- ISO connector.

PRODUCT CODE  
**71 APP085**



**AERPRO HARNESS ISO TO HYUNDAI - KIA**

The primary harness is the harness that plugs into your car's main entertainment system connector and converts it into a double ISO connector system (universal).

- ISO connector.
- Suits: Range of Hyundai and Kia models.

PRODUCT CODE  
**71 APP086**



**AERPRO HARNESS ISO TO SUIT HYUNDAI**

Aerpro ISO harnesses make upgrading a vehicles headunit a simple task by converting the OEM radio plug to ISO connectors.

- Easy plug and play solution
- Converts Vehicles Radio Plug to ISO Connectors

PRODUCT CODE  
**71 APP087**

■ MAZDA



**AERPRO AUX INPUT ADAPTER MAZDA**

Connect directly from your device's audio outlet using these "AUX" input adaptor harnesses that wire directly into on your car stereo system. The Aerpro patch leads are custom made to connect your chosen brand of headunit to the steering wheel control adapter.

- Mazda OEM Plug to RCA inputs.
- Run auxiliary audio into factory head unit.
- Suits Mazda vehicles 2006 onwards.
- For cars with media or aux Button (will not suit older cars with Tape/MD button).

PRODUCT CODE  
**71 APMZAUX**



**AERPRO HARNESS ISO TO MAZDA 2000 ON**

The primary harness is the harness that plugs into your car's main entertainment system connector and converts it into a double ISO connector system (universal).

- Suits: Mazda 3 F/ Sedan 01, Mazda 626/ Tribute - 00, Mazda MX5 - 2001, Mazda RX8 - 2003, Mazda 3 - 2004, Mazda 2 - 2003 and/or Ford Ranger 2007 - 2010.
- Converts vehicle specific plug to universal ISO connector system.
- Secure Clips on ISO connectors to ensure secure and long lasting connection
- Provides a Plug & Play installation solution for aftermarket headunits when paired with an Aerpro APP8 Secondary Harness (some hard-wiring may still be required)

PRODUCT CODE  
**71 APP072**



**AERPRO CONTROL HARNESS C FOR MAZDA**

This Aerpro control harness allows you to upgrade to an aftermarket head unit whilst maintaining use of your factory steering wheel controls.

- Steering wheel control, use with aftermarket radio.
- Requires type C patch lead.

PRODUCT CODE  
**71 CHMZ3C**

■ MITSUBISHI



**AERPRO HARNESS ISO TO MITSUBISHI 1996 ON**

The primary harness is the harness that plugs into your car's main entertainment system connector and converts it into a double ISO connector system (universal).

- ISO connector system
- Suits: Most late model Mitsubishi.
- 1 plug type.

PRODUCT CODE  
**71 APP0111**



**AERPRO HARNESS ISO TO SUIT MITSUBISHI**

The primary harness is the harness that plugs into your car's main entertainment system connector and converts it into a double ISO connector system (universal).

- Suits:- Mitsubishi: Outlander, Lancer, Pajero 2007 on & Peugeot: 4007 2009 on.
- ISO connector.
- Easy plug and play solution.

PRODUCT CODE  
**71 APP0113**



**AERPRO CONTROL HARNESS C MITSUBISHI**

This Aerpro control harness allows you to upgrade to an aftermarket head unit whilst maintaining use of your factory steering wheel controls.

- Steering wheel control, use with aftermarket radio.
- Requires type C patch lead.
- Retains the factory steering wheel controls.
- Plug and play.

PRODUCT CODE  
**71 CHMB1C**

■ NISSAN



**AERPRO HARNESS ISO TO NISSAN 1995 ON**

The primary harness is the harness that plugs into your car's main entertainment system connector and converts it into a double ISO connector system (universal).

- ISO connector to suit most Nissan models with smaller plug type e.g. 350Z, Maxima, 200SX, Pathfinder, X-Trail, XTerra, later Patrol etc.
- Vehicle specific plug designed to connect directly into the vehicles original headunit wiring loom, no need to remove the factory plug
- Secure Clips on ISO connectors to ensure secure and long lasting connection
- Provides a Plug & Play installation solution for aftermarket headunits when paired with an Aerpro APP8 Secondary Harness (some hard-wiring may still be required)

PRODUCT CODE  
**71 APP0120**



**AERPRO HARNESS ISO TO NISSAN 1987-94**

The primary harness is the harness that plugs into your car's main entertainment system connector and converts it into a double ISO connector system (universal).

- ISO connector to suit most Nissan models with larger plug type e.g. Pulsar, Pintara etc. 1987 onwards.

PRODUCT CODE  
**71 APP0121**

■ SUBARU



**AERPRO HARNESS ISO TO SUBARU 1989 ON**

The primary harness is the harness that plugs into your car's main entertainment system connector and converts it into a double ISO connector system (universal).

- Suits: Most Subaru models.
- Converts vehicle specific plug to universal ISO connector system.
- Secure Clips on ISO connectors to ensure secure and long lasting connection
- Provides a Plug & Play installation solution for aftermarket headunits when paired with an Aerpro APP8 Secondary Harness (some hard-wiring may still be required)

PRODUCT CODE  
**71 APP090**

■ SUBARU/MAZDA



**AERPRO RETENTION HARNESS TO SUIT MAZDA/SUBARU**

Amplified speaker converter for Mazda CX5 2015-2017 and Subaru WRX 2014-2015 vehicles with factory amplified systems. Designed to retain amplified speakers when installing a compatible aftermarket headunit.

- Enables amplified speakers in Mazda CX5 and Subaru WRX vehicles to work with aftermarket headunits.
- ISO speaker connector to 4 RCA plugs for simple installation.
- Aftermarket headunit requires front and rear RCA outputs.

PRODUCT CODE  
**71 APP7220**

■ SUBARU/NISSAN



**AERPRO HARNESS ISO TO NISSAN & SUBARU 2007 ON**

The primary harness is the harness that plugs into your car's main entertainment system connector and converts it into a double ISO connector system (universal).

- Universal Female ISO connectors to bare ends.
- Suits: Subaru Impreza 2007-on.
- Suits: Nissan Maxima, Navara and Pathfinder 07-on, Nissan Tiida 60-on, X-Trail 07-on.
- Provides a Plug & Play installation solution for aftermarket headunits when paired with an Aerpro APP8 Secondary Harness (some hard-wiring may still be required)

PRODUCT CODE  
**71 APP091**

■ TOYOTA



**AERPRO HARNESS BARE WIRE TO TOYOTA 1987 ON**

Allowing for the installation of an aftermarket headunit without the need to remove the factory plug from the vehicle, AP1761 provides colour-coded bare end wires to match standard aftermarket radio wiring looms.

- Connects to vehicle's factory wiring, providing bare end wires
- No need to remove the factory stereo plug from the vehicle
- Colour coded wires to match standard aftermarket wiring loom for simple identification and easy installation
- Simply match the colours from this harness to the aftermarket headunit harness and hard-wire (solder) them together
- Solder (or crimps) and heat shrink (or insulation tape) required for installation, not included

PRODUCT CODE  
**71 AP1761**



**AERPRO HARNESS ISO TO EARLY TOYOTA**

The Aerpro APP0140 is a Primary Harness designed to plug into your Toyota Camry, Hilux and HiAce factory headunit vehicle wiring system. It allows for the installation of an aftermarket headunit without the need to remove the factory wiring plug from the vehicle.

- Designed for quick, simple and precise aftermarket headunit wiring installation
- Vehicle specific plug designed to connect directly into the vehicles original headunit wiring loom, no need to remove the factory plug
- Converts vehicle specific plug to universal ISO connector system
- Provides a Plug & Play installation solution for aftermarket headunits when paired with an Aerpro APP8 Secondary Harness (some hard-wiring may still be required)
- Secure Clips on ISO connectors to ensure secure and long lasting connection
- Suits most early model Toyota vehicles, larger 2 plug connection

PRODUCT CODE  
**71 APP0140**



**AERPRO HARNESS ISO TO TOYOTA 1987 ON**

The primary harness is the harness that plugs into your car's main entertainment system connector and converts it into a double ISO connector system (universal).

- ISO Connector to most later Toyota models, smaller 2-plug type.
- Secure Clips on ISO connectors to ensure secure and long lasting connection
- Converts vehicle specific plug to universal ISO connector system
- Provides a Plug & Play installation solution for aftermarket headunits when paired with an Aerpro APP8 Secondary Harness (some hard-wiring may still be required)

PRODUCT CODE  
**71 APP0141**

■ SUZUKI



**AERPRO CONTROL HARNESS C FOR SUZUKI**

This Aerpro control harness allows you to upgrade to an aftermarket head unit whilst maintaining use of your factory steering wheel controls.

- Patch lead: Type C.
- Retains the factory steering wheel controls.
- Suits: Kizashi 2010 onwards, Swift 2005 onwards, SX4 2007-2013, Grand Vitara 2002 onwards.
- For vehicles without phone buttons on steering wheel.

PRODUCT CODE  
**71 CHS21C**

■ VOLKSWAGEN



**AERPRO ISO LINE CONVERTER FOR VW**

This Aerpro ISO Line Converter serves as an amplified speaker converter for various Volkswagen vehicles. This harness has been designed to retain amplified speakers in various Volkswagen vehicles when installing an aftermarket headunit.

- Enables amplified speakers in various Volkswagen models to work with aftermarket headunits
- Standard ISO connector system, easy installation
- Plugs inline with speaker system wiring

PRODUCT CODE  
**71 APP7210**



**AERPRO CONTROL HARNESS C FOR VW**

This Aerpro control harness allows you to upgrade to an aftermarket head unit whilst maintaining use of your factory steering wheel controls.

- Steering wheel control, use with aftermarket radio.
- Requires type C patch lead.
- Plug and play.
- Retains the factory steering wheel controls.

PRODUCT CODE  
**71 CHVW3C**



**AERPRO HARNESS CONTROL C FOR TOYOTA**

This Aerpro control harness allows you to upgrade to an aftermarket head unit whilst maintaining use of your factory steering wheel controls.

- Suits: Corolla, Rav4 - 2011, Camry with Standard Head unit 08/06-10, Aurion with standard head unit 07-10, Hilux 08-11, Prius 2004 - 2008.
- Patch lead: Type C.
- Plug and play.
- Retains the factory steering wheel controls.

PRODUCT CODE  
**71 CHT02C**



**AERPRO CONTROL HARNESS C FOR TOYOTA**

This Aerpro control harness allows you to upgrade to an aftermarket head unit whilst maintaining use of your factory steering wheel controls.

- Suits: Camry 2012 onwards with 28 pin connector, Hilux 2012 onwards with 28 pin connector, RAV 4 2012 onwards with 28 pin connector, Yaris 2012 onwards with 28 pin connector.
- Patch lead: Type C.
- Plug and play.
- Retains the factory steering wheel controls.

PRODUCT CODE  
**71 CHT03C**

ALPINE



**AERPRO HARNESS ALPINE 16 PIN SQUARE TO ISO**

Aerpro "APP8" Secondary Harnesses are a headunit specific harness that converts your aftermarket headunits plug to universal ISO connectors. Aerpro APP8 harnesses packs work in conjunction with Aerpro "CH" Steering Wheel Control Harnesses and Aerpro "APP" Primary ISO Harnesses.

- Suits Alpine car audio units with square pins
- 16-pin plug (square pins)
- Square holes

PRODUCT CODE  
**71 APP8ALPH**



**AERPRO HARNESS ALPINE 16 PIN SQUARE TO ISO**

Aerpro's range of secondary harnesses will plug into any Aerpro Primary Harness including the Steering Wheel Control Adapter type. Simply select the secondary harness based on the head unit brand and its connector.

- Suits Alpine car AV units with square pins
- Includes Hand Brake wire

PRODUCT CODE  
**71 APP8ALPV**



**AERPRO ALPINE TO ISO WITH PATCH LEAD**

Aerpro "APP9" harness packs include both the headunit specific ISO harness and the headunit specific patch lead for steering wheel control interface. Aerpro ISO Harnesses convert your aftermarket headunits plug to universal ISO connectors.

- 16-Pin Plug (square pins)
- Includes Patch Lead for Steering wheel control
- Converts Headunit Plug to ISO
- Includes SWC Input Wire
- Bullet Connectors Fitted to Main Power Wires
- Works With Aerpro Vehicle Specific Harnesses

PRODUCT CODE  
**71 APP9ALPH**

JVC



**AERPRO HARNESS ALPINE TO ISO WITH PATCH LEAD**

Aerpro's range of Secondary Harnesses with Patch Lead are designed to plug into any Primary Steering Wheel Control Adapter. First select the vehicle SWC harness, then select the secondary harness based on the head unit brand and its connector.

- Suits Alpine car AV units with square pins
- Includes hand brake wire
- Includes patch lead for steering wheel control

PRODUCT CODE  
**71 APP9ALPV**



**AERPRO HARNESS JVC 16 PIN TO ISO**

Aerpro's range of secondary harnesses will plug into any Aerpro primary harness including the steering wheel control adapter type. Simply select the secondary harness based on the head unit brand and its connector.

- Suits JVC car audio units.
- 16-pin.

PRODUCT CODE  
**71 APP8JVC3**



**AERPRO HARNESS JVC 16 PIN TO ISO**

Aerpro ISO harnesses convert your aftermarket headunits plug to universal ISO connectors.

- Suits JVC car audio units. 16-pin.
- Includes SWC input wire.
- Bullet connectors fitted to main power wires.
- Converts the aftermarket headunit plug into a universal double ISO connector.
- Secure Clips on ISO connectors and headunit plug to ensure secure and long lasting connection
- Provides a Plug and Play installation solution when paired with an Aerpro Vehicle Specific Harness; APP Series Primary ISO Harness, Steering Wheel Control Interface or Infodapter.

PRODUCT CODE  
**71 APP8JVC5**

JVC (CONTINUED)



**AERPRO JVC TO ISO WITH PATCH LEAD**

Aerpro's range of Secondary Harnesses with Patch Lead are designed to plug into any Primary Steering Wheel Control Adapter. First select the vehicle SWC harness, then select the secondary harness based on the head unit brand and its connector.

- JVC to ISO harness.
- Includes patch lead for steering wheel control.

PRODUCT CODE  
**71 APP9JVC3**



**AERPRO JVC TO ISO WITH PATCH LEAD**

The ISO harnesses convert your aftermarket headunits plug to universal ISO connectors and includes the correct steering wheel control patch lead.

- JVC to ISO harness.
- Includes patch lead for steering wheel control.
- Includes mute signal wire and SWC input wire.
- Bullet connectors fitted to main power wires.

PRODUCT CODE  
**71 APP9JVC5**



**AERPRO PATCH LEAD JVC SUITS APUCB**

Aerpro patch leads are custom made to connect your chosen brand of headunit to the steering wheel control adapter. This JVC patch lead suits type C control harnesses.

- Plugs into APUCB Can-Bus and control C series.

PRODUCT CODE  
**71 APJVCPL**

KENWOOD



**AERPRO HARNESS KENWOOD TO ISO**

Aerpro's range of secondary harnesses will plug into any Aerpro primary harness including the steering wheel control adapter type. Simply select the secondary harness based on the head unit brand and its connector.

- 22-pin Kenwood to ISO harness.
- Suits: DDX916WS, DDX9016DABS, DNX8160DABS and JVC KW-V820BT.

PRODUCT CODE  
**71 APP8KE4**



**AERPRO HARNESS KENWOOD TO ISO 16 PIN**

Aerpro "APP8" ISO Harnesses convert your aftermarket headunits plug to universal ISO connectors. Aerpro APP8 harnesses work in conjunction with Aerpro "CH" Steering Wheel Control Harnesses and Aerpro "APP" Primary ISO Harnesses.

- Converts headunit plug to iso
- Includes mute signal and SWC input wires
- Bullet connectors fitted to main power wires
- Works with aerpro vehicle specific harnesses

PRODUCT CODE  
**71 APP8KE5**



**AERPRO HARNESS ISO TO SUIT KENWOOD**

22-pin Kenwood to suit headunits using an add on CMOS3XX series Camera and camera controller.

PRODUCT CODE  
**71 APP8KE6**

■ PANASONIC



**AERPRO HARNESS PANASONIC TO ISO**

Aerpro's range of secondary harnesses will plug into any Aerpro primary harness including the steering wheel control adapter type. Simply select the secondary harness based on the head unit brand and its connector.

- Suits: all latest model Panasonic units.
- 16 pin plug.
- Easy DIY installation.

PRODUCT CODE  
**71 APP8PAN**



**AERPRO PIONEER TO ISO WITH PATCH LEAD**

Aerpro's range of secondary harnesses with patch lead are designed to plug into any primary steering wheel control adapter. First select the vehicle steering wheel control harness then select the secondary harness based on the head unit brand and its connector.

- Suits most of the latest Pioneer head units.
- 16 pin plug.
- Includes patch lead for steering wheel control.
- Bullet connectors for constant, ACC and earth wires.

PRODUCT CODE  
**71 APP9PIO5**

■ PIONEER



**AERPRO HARNESS PIONEER 16 PIN TO ISO**

Aerpro's range of secondary harnesses will plug into any Aerpro primary harness including the steering wheel control adapter type. Simply select the secondary harness based on the head unit brand and its connector.

- Converts the aftermarket headunit plug into a universal double ISO connector system
- 16 pin plug.
- Secure Clips on ISO connectors and headunit plug to ensure secure and long lasting connection
- Suits Pioneer units: DEH1350MPG, DEH2250UBC, DEH4350UB, DEH3250UB, DEH3350UB, DEH4250SD, DEH5250SD, DEH6350SD, DEH7350BT.

PRODUCT CODE  
**71 APP8PIO5**



**AERPRO PIONEER TO ISO WITH PATCH LEAD**

Converts your aftermarket headunits plug to universal ISO connectors. Patch leads plug into the steering wheel control signal input of the aftermarket headunit and into the vehicle specific type C steering wheel control harness.

- 16-pin plug (square pins).
- Includes patch lead for steering wheel control.
- Converts headunit plug to ISO.
- Includes handbrake, speed signal and illumination input wire.
- Bullet connectors fitted to main power wires.

PRODUCT CODE  
**71 APP9PIO8**



**AERPRO HARNESS ISO TO PIONEER 16 PIN**

Aerpro's range of secondary harnesses will plug into any Aerpro primary harness including the steering wheel control adapter type. Simply select the secondary harness based on the head unit brand and its connector.

- Suits most late model Pioneer head units.
- Pioneer to ISO harness 16 pin.
- Includes handbrake, vss and reverse camera trigger wires
- Secure Clips on ISO connectors and headunit plug to ensure secure and long lasting connection

PRODUCT CODE  
**71 APP8PIO8**



**AERPRO PATCH LEAD PIONEER SUITS APUCB**

Aerpro patch leads are custom made to connect your chosen brand of head unit to the steering wheel control adapter.

- Type C patch lead.
- Plugs into APUCB Can-Bus and control harness C.

PRODUCT CODE  
**71 APPIOPL**

■ SONY



**AERPRO HARNESS SONY 16 PIN TO ISO**

Aerpro's range of secondary harnesses will plug into any Aerpro primary harness including the steering wheel control adapter type. Simply select the secondary harness based on the head unit brand and its connector.

- Suits all Sony head units up to 2012.
- 16 pin plug.

PRODUCT CODE  
**71 APP8SP**



**AERPRO SONY TO ISO WITH PATCH LEAD**

Aerpro's range of secondary harnesses with patch lead are designed to plug into any primary steering wheel control adapter. First select the vehicle steering wheel control harness then select the secondary harness based on the head unit brand and its connector.

- Suits Sony model head units 2013 on.
- Sony to ISO 16 pin harness.
- Includes patch lead for steering wheel control.

PRODUCT CODE  
**71 APP9SP3**

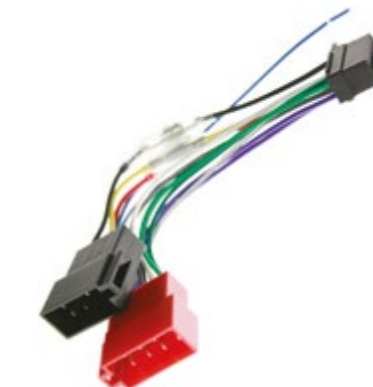

**AERPRO HARNESS SONY 16-PIN TO ISO**

Aerpro's range of secondary harnesses will plug into any Aerpro primary harness including the steering wheel control adapter type. Simply select the secondary harness based on the head unit brand and its connector.

- Suits Sony model head units 2013 on.
- 16 pin plug designed specifically to suit various Sony Aftermarket Headunits.
- Secure Clips on ISO connectors and headunit plug to ensure secure and long lasting connection.

PRODUCT CODE  
**71 APP8SP3**



**AERPRO SONY TO ISO WITH PATCH LEAD**

Aerpro's range of secondary harnesses with patch lead are designed to plug into any primary steering wheel control adapter. First select the vehicle steering wheel control harness then select the secondary harness based on the head unit brand and its connector.

- Sony to ISO 16 pin harness.
- Includes patch lead for steering wheel control.

PRODUCT CODE  
**71 APP9SP4**

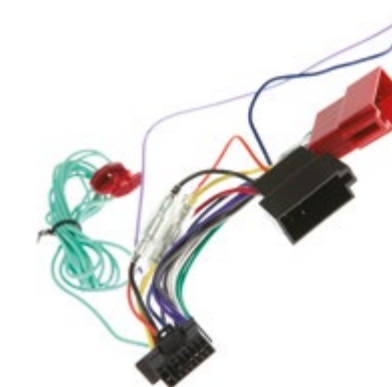

**AERPRO HARNESS SONY AV 16 PIN TO ISO**

Aerpro's range of secondary harnesses will plug into any Aerpro primary harness including the steering wheel control adapter type. Simply select the secondary harness based on the head unit brand and its connector.

- Suits: Sony AV model head units 2013 onwards.
- Sony to ISO 16 pin harness.
- Includes handbrake and reverse camera trigger wires.
- Converts the aftermarket headunit plug into a universal double ISO connector system.
- Secure Clips on ISO connectors and headunit plug to ensure secure and long lasting connection.

PRODUCT CODE  
**71 APP8SP4**



**AERPRO PATCH LEAD SONY SUITS APUCB**

Aerpro patch leads are custom made to connect your chosen brand of headunit to the steering wheel control adapter.

- Also suits control harness C.
- Patch lead to suit Sony head unit.
- Plugs directly into APUCB can-bus and control harness C series.

PRODUCT CODE  
**71 APSONYPL**

■ UNIVERSAL



**AERPRO PATCH LEAD TYPE C UNIVERSAL SELF LEARN**

Suits Type C steering wheel control modules. Fits many head units from the top brands. Will suit headunits with self learning capabilities.

PRODUCT CODE  
**71 APUNIPL2**



**AERPRO USB ADAPTOR TO RETAIN OE USB**

Retains OE USB port on select Toyota and Lexus vehicles

- Toyota: 2012 onwards
- Lexus: 2013 onwards

PRODUCT CODE  
**71 APTOUSB1**



**AERPRO UNIVERSAL SWC INCLUDES PATCH LEAD**

Universal steering wheel control adapter to suit a wide range of vehicles including Australian built models. Version 2 now has even more applications.

- Includes universal patch lead to suit Alpine, Clarion, JVC, Kenwood, Nakamichi, Panasonic, Philips, Pioneer, Sony, Zenec and Chinese learning models.

PRODUCT CODE  
**71 APUNISW2**



**AERPRO UNIVERSAL SWC INTERFACE**

The APUNISW5 is a universal steering wheel control interface that retains a host of vital OEM vehicle features when upgrading the head unit to an aftermarket model, including steering wheel controls, phone buttons, settings menus and more.

PRODUCT CODE  
**71 APUNISW5**



**AERPRO UNIVERSAL VEHICLE USB LEAD**

Mini USB-B "clip in" connector found in Nissan, Ford and Holden vehicles to Standard USB male connector.

- Maintains use of factory steering wheel controls.
- Increases driver safety by allowing you to keep your hands on the steering wheel and eyes on the road.
- Supports OEM Phone Button when connected to compatible aftermarket bluetooth headunits.
- Voice Assistant Button support available with software update (please contact your Authorised Aerpro Dealer for update).
- Provides output feeds for park brake, reverse gear and speed pulse.
- CAN-BUS integration compatible, no additional modules required for CAN-BUS vehicles.
- Compatible with OEM MOST 25 fibre optic amplified audio systems.
- Not compatible with Harmon Kardon OEM amplified vehicles.
- Fitted with a vehicle specific plug, no cutting of wires required.

PRODUCT CODE  
**71 APUNIUSB**



**AERPRO SPEAKER LEAD ADAPTOR FORD & MAZDA**

OEM Speaker Adaptors allow you to connect your aftermarket speakers to your vehicle's factory wiring.

- Speaker Adapter to suit Ford and Mazda
- Factory plug to aftermarket speakers
- Plug and play
- Sold in pairs

PRODUCT CODE  
**71 APS22**



**AERPRO SPEAKER LEAD ADAPTOR FORD & HOLDEN**

Speaker Adapter to suit Ford, Holden, Suzuki, Kia, VW. Factory plug to aftermarket speakers.

- Plug and Play
- Sold in Pairs

PRODUCT CODE  
**71 APS52**



**AERPRO SPEAKER ADAPTOR T/S FORD/ HOLDEN/SUBARU**

OEM Speaker Adaptors allow you to connect your aftermarket speakers to your vehicle's factory wiring.

- Speaker Adapter to suit Holden, Subaru, Suzuki
- Factory plug to aftermarket speakers
- Plug and Play
- Locking Clip
- Sold in Pairs

PRODUCT CODE  
**71 APS58**



**AERPRO SPEAKER LEAD ADAPTOR NISSAN**

Speaker Adapter to suit Nissan: Factory plug to aftermarket speakers

- Plug and Play
- Sold in Pairs

PRODUCT CODE  
**71 APS34**



**AERPRO SPEAKER LEAD ADAPTOR TOYOTA**

OEM Speaker Adaptors allow you to connect your aftermarket speakers to your vehicle's factory wiring.

- Factory plug to aftermarket speakers
- Plug and Play
- Sold in Pairs
- May not be compatible with factory JBL Audio

PRODUCT CODE  
**71 APS32**



**AERPRO SPEAKER LEAD ADAPTOR TOYOTA**

Speaker Adapter to suit Mitsubishi, Hyundai, Toyota

- Factory plug to aftermarket speakers
- Plug and Play
- Sold in Pairs

PRODUCT CODE  
**71 APS36**



**AERPRO  
REVERSE CAMERA RETENTION  
HARNESS ISUZU**

OEM Reverse camera Retention harness to suit Isuzu.

- Wiring: Pink - VSS out, Green - Park Brake out, Violet - Reverse 12v out

PRODUCT CODE  
**71 APVIZ01**



**AERPRO  
REVERSE CAMERA RETENTION  
HARNESS MITSUBISHI**

OEM Reverse camera Retention harness to suit Mitsubishi

- Models: Outlander 2013 on and Pajero Sport 2015 on.

PRODUCT CODE  
**71 APVMT01**



**AERPRO  
REVERSE CAMERA RETENTION  
HARNESS FOR TOYOTA**

OEM Reverse camera Retention harness to suit Toyota (Various models 2012-2014).

- The black wire is the ground wire, the violet/white wire is the trigger to the back of the head unit and the green wire is the park brake output

PRODUCT CODE  
**71 APVTY01**



**AERPRO  
REVERSE CAMERA RETENTION  
HARNESS FOR TOYOTA**

OEM Reverse camera Retention harness to suit most Toyota's from 2014 onwards

- Models: Landcruiser, Camry, Corolla, Hilux, Kluger, Landcruiser, Prius, Yaris, Rav-4 and Tundra

PRODUCT CODE  
**71 APVTY02**



**AERPRO  
REVERSE CAMERA RETENTION  
HARNESS FOR TOYOTA**

Suitable for use with Toyota Prado 150 2009-2013 with reverse image in small screen above factory headunit. APVTY05 Aerpro camera adapter harness allows the factory reverse camera image to display on compatible aftermarket headunits.

- Also enables aftermarket camera to be connected to the factory OEM display screen
- Compatible with all aftermarket reverse cameras that have an RCA connection
- Plug and play design with vehicle specific connectors, making it simple to install
- Maintains the factory information screen in the vehicle

PRODUCT CODE  
**71 APVTY03**



**AERPRO  
REVERSE CAMERA RETENTION  
HARNESS FOR TOYOTA**

OEM Reverse camera retention harness to suit Toyota 4-pin.

PRODUCT CODE  
**71 APVTY04**

# KICKER®

## 10IN SUB ENCLOSURE TO SUIT FORD RANGER & MAZDA BT-50

### BIG BASS ANYWHERE

The Sub box comes loaded with a Kicker 10inch CompRT active subwoofer, an all-weather thin sub with a pair of 2-Ohm voice coils, **400W RMS of power** and SoloKon technology.



### STYLE

Covered in stylish black carpeting, this enclosure gives you all the power without taking up needed space; place it under your seat for great bass and get the maximum performance.

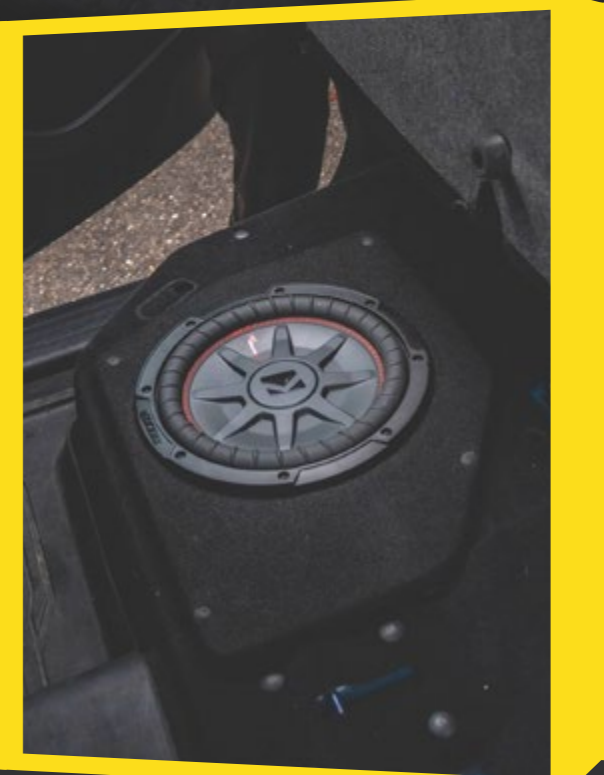

**Code: 80 KSBFRBT10**  
**9415553127370**

### FITS THESE 4 VEHICLES



- Mazda BT-50 (2016-2020)
- BT-50 2015-2017 GT, XTR
  - BT-50 2018-2019



- Ford Ranger (2015-2021)
- 2015-2018 PX MkII
  - 2018- PX MkIII

### ENCLOSURE

Constructed from 4mm fibreglass with a double layer front baffle. 14 Litre / 0.50 Cubic Foot internal volume.





**AERPRO CARPET MDF SPACER 6.5IN GREY PAIR**

Have what you need to complete your car's stereo system installation or simply to make it work according to its design intent. The speaker spaces are designed for 6.5 inch speakers and provides extra space to mount speakers in areas with insufficient space.

- Solid MDF spacer.
- Sold as pair.
- Up to a depth of 25mm for speakers.

PRODUCT CODE  
**75 AP3062C**



**AERPRO MDF SPEAKER SPACER 6X9 PAIR**

The AP3181 speaker spaces are designed for 6 inch x 9 inch speakers.

- These spacers are 16mm thick, allowing your speakers to clear objects behind them
- Pre-drilled Mounting Holes

PRODUCT CODE  
**75 AP3181**



**AERPRO CARPET MDF SPACER 6X9IN GREY PAIR**

Make sure you have what you need to complete your car's stereo system installation or simply to make it work according to its design intent.

- Solid MDF spacer.
- Sold as pair.

PRODUCT CODE  
**75 AP3081C**



**AERPRO SUBWOOFER MOUNTING STRAPS 400MM PAIR**

Mounting Straps

- 2 x 400mm x 24mm
- Black
- Quick Disconnect
- Screws included: (4 x 22.5) x 8

PRODUCT CODE  
**75 APMS400**

**AERPRO SUBWOOFER MOUNTING STRAPS 1500MM PAIR**

2 mounting straps to be used for a subwoofer.

- Mounting Straps: 2 x 1500mm x 24mm
- Black
- Quick Disconnect
- Screws included: 8 x 15mm

PRODUCT CODE  
**75 APMS1500**



**AERPRO PLASTIC SPEAKER SPACER 5.25 - 6.5IN PAIR**

The AP316 speaker spaces are designed for 5.25 inch to 6.5 inch speakers.

- UV stabilised
- Pre-drilled Mounting Holes

PRODUCT CODE  
**75 AP316**



**AERPRO SPEAKER SPACER TO SUIT TOYOTA 165MM**

Speaker spacer to suit Toyota.

- To suit 165mm speakers
- Includes mounting hardware

PRODUCT CODE  
**75 APS331**



**AERPRO MDF SPEAKER SPACER 6.5IN PAIR**

The AP3161 speaker spaces are designed for 6.5 inch speakers.

- Pre-drilled Mounting Holes
- 16mm depth
- Outer diameter: 182mm
- Sold as a pair

PRODUCT CODE  
**75 AP3161**



**AERPRO SPEAKER SPACER TO SUIT VW 165MM**

Speaker spacer to suit Volkswagen

- To suit 165mm Speakers
- Front/Rear/Rear Parcel Shelf
- Rear only on Golf MK5
- Front Skoda Octavia 2014on Non Amplified system

PRODUCT CODE  
**75 APS353**



**AERPRO SPEAKER BOX 6 X 9IN PORTED BLACK CARPET PAIR**

All Aerpro Subwoofer Boxes are tuned by professionals for the optimal output for their respective budget and applications.

- Angled ported MDF speaker boxes.
- Covered in black carpet with grey sides.
- Ideal for utes, vans and on parcel shelves

PRODUCT CODE  
**75 PB6902**



**AERPRO SPEAKER BOX SEALED 6 X 9IN PAIR**

The sub boxes are custom engineered by Aerpro's team of experts. All of the subwoofer boxes are tuned by professionals for optimal output for their respective budget and applications. This speaker box is a dual sealed 6in x 9in speaker box set.

- 6in X 9in speaker enclosures.
- Enclosure volume: 0.4 CubFt.
- Dimensions: 185mmH x 300mmL x 220mmW.
- Connecting cables included.

PRODUCT CODE  
**75 SB69A**



**AERPRO SUB BOX 12IN SEALED 1CFT BLK**

The sub boxes are custom engineered by Aerpro's team of experts. All of the subwoofer boxes are tuned by professionals for optimal output for their respective budget and applications.

- Single 12in (305mm) sealed subwoofer enclosure.
- Enclosure volume: 1.0 cubic foot.
- Cut out on angled side of box.
- Dimensions: 350mmH X 460mmW X 320mmD.

PRODUCT CODE  
**75 SB12100**



**AERPRO SPEAKER GRILLES 6X9 COMMODORE VT-VY GREY**

The replacement grilles are used to replace the original grilles when removing factory fitted speakers. The grilles are a dual pack of two 6in x 9in speaker grilles.

- 6 x 9 speaker grilles used to replace the original grilles when removing factory fitted speakers.
- Suits VT/VY Commodore.
- Easy installation.

PRODUCT CODE  
**75 VTVY96**



**AERPRO SPEAKER BOX SEALED 6IN PAIR**

Our sub boxes were custom engineered by our team of experts. All of our subwoofer boxes are tuned by professionals for the optimal output for their respective budget and applications. The subwoofer box is a dual 6in speaker box set.

- 6in speaker enclosures.
- 125mm hole cut out.
- Enclosure volume: 0.3 CubFt.
- Dimensions: 205mm H x 210mm L x 230mm W.
- Connecting cables included.

PRODUCT CODE  
**75 SB60A**



**AERPRO TWO CHANNEL LINE OUTPUT CONVERTER**

AP3042A is a super compact 2-channel line output converter. Ideal for adding aftermarket amplifiers to factory headunits in most 12V vehicles.

- 2-Channel
- Step Down Adjustable Channel Gain
- Remote Out Trigger
- Signal Noise Filter
- Super Compact Design
- LED Power Indicator

PRODUCT CODE  
**73 AP3042A**



**AERPRO FOUR CHANNEL LINE OUTPUT CONVERTER**

Aerpro Line Output Converters will convert your existing cars factory headunits high level (speaker output) into a low voltage line level (RCA) output allowing you to add on an aftermarket amplifier to an OEM headunit.

- Remote output trigger
- LED power indicator
- Eliminates signal noise
- Audio ground
- Individual channel gains
- Adjustable 6:1 stepdown gain

PRODUCT CODE  
**73 AP3044A**



**AERPRO POWER DISTRIBUTION BLOCK 4GX2 TO 8GX4**

A solid brass gold plated distribution block allowing cable of 4Gx2 to be split into 8Gx4 cable. Can also be used as a reducer to allow cable to match the feed size of a amplifiers terminal board.

- Solid brass.
- Gold plated.
- Clear perspex cover.
- Hex set screws.

PRODUCT CODE  
**73 AP406**



**AERPRO POWER DISTRIBUTION BLOCK 0GX1 TO 4GX4**

Split power and ground cables into multiple feeds so as to power more devices from the one battery cable. They can also reduce the cable size at the same time to facilitate the cable input feed size of the amplifiers terminal board.

- Solid brass.
- Gold plated.
- Clear perspex cover.
- Hex set screws.

PRODUCT CODE  
**73 AP410**



**AERPRO AGU IN-LINE FUSE HOLDER 4GA OR 8GA**

A fuse holder suitable for 4 gauge or 8 gauge power cables.

- Suitable for 4 or 8 gauge power cable.
- Anti-loosening screw end with waterproof grommets.
- Gold plated fittings.
- Allen key screws for connecting power cable.

PRODUCT CODE  
**73 AP452A**



**AERPRO AGU FUSE PK5**

The product is a 5 pack of AGU fuses.

- Gold plated end caps.

PRODUCT CODE  
**73 AP459 40AMP**  
**73 AP460 50AMP**  
**73 AP461 60AMP**



**AERPRO ANL IN-LINE FUSE HOLDER 0, 2 OR 4GA**

Use Aerpro fuse holders to keep systems fuse securely in place. The AP462A suits multiple cable gauges from 0 down to 4 AWG so it's perfect for almost any size system.

- Suits 0,2 and 4 AWG Cable
- Solid Brass Connectors with Satin Chrome Finish
- High-Temp PC Base and Cover
- 4-Point Base Mounting
- Fuse not included.

PRODUCT CODE  
**73 AP462A**



**AERPRO ANL FUSE**

Suits AP462A fuse holder.

PRODUCT CODE  
**73 AP466 80AMP**  
**73 AP467 100AMP**  
**73 AP468 150AMP**  
**73 AP469 200AMP**



**AERPRO CIRCUIT BREAKER 60AMP 4GA OR 8GA**

The AP484 is a 60 Amp Inline/ Panel mount circuit breaker which is compatible with 4 & 8 ga cables.

- Gold plated fittings
- Moisture and dust protected

PRODUCT CODE  
**73 AP484**



**AERPRO BATTERY TERMINAL NEGATIVE 4-WAY**

Bare wires can short unexpectedly and damage your equipment. Use of these terminals are necessary to reduce the chances of this happening, while making your installation look great.

- Battery terminal, negative
- Suits 1x4ga, 1x2ga, 2x8ga cable
- Set screw type
- Gold plated
- Suits 15mm terminals

PRODUCT CODE  
**73 AP502**



**AERPRO BATTERY TERMINAL POSITIVE 4-WAY**

Bare wires can short unexpectedly and damage your equipment. Use our terminals where necessary and you not only reduce the chances of this but also make your installation look great.

- Positive battery terminal.
- Suits: 1x 4GA, 1x 2GA, 2x 8GA cable.
- Gold plated.
- Suits: 15mm terminals.
- Set screw type.

PRODUCT CODE  
**73 AP503**



**AERPRO 4GA RING TERMINAL**

The AP610 is a 4 gauge Ring terminal, fully gold plated and solid brass.

- Gold plated Brass for excellent conductivity.
- Suit 8mm posts.

PRODUCT CODE  
**73 AP610**



**AERPRO VOLTAGE REDUCER 24V TO 12V DC 6A**

Specifically for the installation 12 volt single or double DIN headunits. It has both a constant and accessories wire, allowing you to retain AM/FM station memory as well as any saved resets on aftermarket headunits.

- Designed for use in 24 volt vehicles.
- Constant wire to retain AM/ FM memory settings.
- Input voltage: 24 volts DC.
- Output voltage: 13.8 volts DC.
- Maximum current output: 6A.

PRODUCT CODE  
**73 AP8286**



**AERPRO VOLTAGE REDUCER 24V TO 12V DC 12A**

Specifically for the installation 12 volt single or double DIN headunits. It has both a constant and accessories wire, allowing you to retain AM/FM station memory as well as any saved resets on aftermarket headunits.

- Designed for use in 24 volt vehicles.
- Constant wire to retain AM/ FM memory settings.
- Input voltage: 24 volts DC.
- Output voltage: 12 volts DC.
- Maximum current output: 12A.

PRODUCT CODE  
**73 AP8287**



**AERPRO TWO PIECE REMOVAL TOOL KIT**

Thinking of doing it yourself? Aerpro has the parts you desire to get the job done. From Sub Woofer box ports to drill bits, they have it all.

- The APRTK2 is a handy 2 piece removal tool kit.
- Made of Nylon and fibreglass material giving you flexibility and strength.
- Avoids scratches on body panels and interior trims.

PRODUCT CODE  
**73 APRTK2**



**AERPRO  
RCA ADAPTOR FEMALE TO  
FEMALE PLASTIC PK2**

The RCA coupler is the perfect fit to change male connectors to a female jack in order to add another length of cable. No need to buy a longer cable, use your existing cable that is just laying around.

- Colour coded terminals.
- Gold plated.
- Packed in pairs.
- Supplied in full colour hang-sell blister.

PRODUCT CODE  
**73 AP622**



**AERPRO  
RING TERMINAL OGA PK2**

Bare wires can short unexpectedly and damage your equipment. Use our terminals where necessary and you not only reduce the chances of this but also make your installation look great.

- 2 x OGA ring terminals.
- 1 x red, 1 x black.

PRODUCT CODE  
**73 APOGRT**



**AERPRO  
RING TERMINAL 4GA PK4**

Bare wires can short unexpectedly and damage your equipment. Use our terminals where necessary and you not only reduce the chances of this but also make your installation look great.

- 4 gauge ring terminals.
- 2 x red, 2 x black.
- Gold plated terminals.

PRODUCT CODE  
**73 AP4GRT**



**AERPRO  
RING TERMINAL 8GA PK12**

Bare wires can short unexpectedly and damage your equipment. Use our terminals where necessary and you not only reduce the chances of this but also make your installation look great.

- Gold plated terminals.
- 6x red, 6x black.
- Suits: 8mm posts.

PRODUCT CODE  
**73 AP702**



**AERPRO  
FORK TERMINAL 4GA PK4**

Bare wires can short unexpectedly and damage your equipment. Use our terminals where necessary and you not only reduce the chances of this but also make your installation look great.

- 4 x crimp style fork terminals.
- Gold plated terminals.
- 2x red, 2x black.
- Suits: 4mm posts.

PRODUCT CODE  
**73 AP701**



**AERPRO  
FORK TERMINAL 12GA PK12**

Bare wires can short unexpectedly and damage your equipment. Use our terminals where necessary and you not only reduce the chances of this but also make your installation look great.

- Gold plated terminals.
- 6x red, 6x black.
- Suits: 4mm posts.

PRODUCT CODE  
**73 AP704**



**AERPRO  
FORK TERMINAL 8GA PK12**

Bare wires can short unexpectedly and damage your equipment. Use our terminals where necessary and you not only reduce the chances of this but also make your installation look great.

- Gold plated terminals.
- 6x red, 6x black.
- Suits: 3mm posts.

PRODUCT CODE  
**73 AP707**



**AERPRO  
SPADE TERMINAL 12GA  
SPEAKER TYPE PK4**

Bare wires can short unexpectedly and damage your equipment. Use our terminals where necessary and you not only reduce the chances of this but also make your installation look great.

- Gold plated terminals.
- 2x large red, 2x small black.
- Ideal as speaker terminals.

PRODUCT CODE  
**73 AP711**

**AERPRO  
SPEAKER CABLE 2 X 10 - 0.12MM 12M GREY**

The AP939/12 is a 12m speaker wire wrapped in a flexible PVC jacket to resist the high temperatures, moisture, corrosion and abrasion present in today's automotive engine bays and boots. Oxygen free copper cable with grey PVC insulation.

- 12 Metre length, 2 x 10/0.12mm

PRODUCT CODE  
**72 AP939-12**



**AERPRO  
SPEAKER CABLE - CLEAR**

Made using ultra-pure oxygen-free copper (OFC) wire wrapped in a flexible PVC jacket to resist the high temperatures, moisture, corrosion and abrasion present in today's automotive engine bays and boots.

- Oxygen free copper cable with clear PVC insulation.
- Polarity Identification with one Silver Core and one Copper Core.

PRODUCT CODE  
**72 AP940 2X40/0.12 - 100M**  
**72 AP941 14G - 100M**  
**72 AP942 12G - 100M**  
**72 AP942-20 12G - 20M**  
**72 AP951 16G - 100M**



**AERPRO  
TRIGGER CABLE 18GA 100M  
BLUE**

BASSIX power cables combine quality components to ensure you receive great performance from your amplifier. The cable offers maximum flexibility allowing cables to easily bend around corners with no loss in performance and providing a neat and professional installation.

- 18GA
- 100M Roll
- Blue Insulation
- Maximum Flexibility

PRODUCT CODE  
**72 BSX18100**



**AERPRO  
POWER CABLE 4GA 30M**

BASSIX power cables combine quality components to ensure you receive great performance from your amplifier.

- 4GA
- 30M Roll
- Colour Insulation
- Maximum Flexibility

PRODUCT CODE  
**72 BSX430B SMOKE GREY**  
**72 BSX430R RED**



**AERPRO  
POWER CABLE 8GA 50M**

The cable offers maximum flexibility allowing cables to easily bend around corners and providing a neat and professional installation.

- 8GA
- 50M Roll
- Colour Insulation
- Maximum Flexibility

PRODUCT CODE  
**72 BSX850B SMOKE GREY**  
**72 BSX850R RED**



**AERPRO  
POWER CABLE 0 AWG 20M**

This power cable combines high quality components to ensure you receive blistering performance from your amplifier. The power cable is supplied on a 20M roll and is ideal for workshops and those who simply need a specific length of cable.

- 0 AWG power cable.
- Maximum flexibility.
- 20 metre reel.

PRODUCT CODE  
**72 MX020B BLUE**  
**72 MX020C CLEAR**



**AERPRO  
AMP WIRING KIT  
2-CH 8GA 450W**

These amplifier kits can handle serious power and include high quality components to enhance the performance of your amplifier. The kit will power up to 450W and includes everything you need to install a 4 channel amplifier into your vehicle.

- 450W max power.
- 8GA power cable.
- Amp power installation kit.
- Twisted pair RCA's with gold plated connectors.
- Includes cable ties, wiring grommet & fitting terminals.

PRODUCT CODE  
**72 BSX208**



**AERPRO  
AMP WIRING KIT  
4-CH 8GA 450W**

These kits can handle serious power and include high quality components to enhance the performance of your amplifier.

- 450W max power
- 8GA power cable
- Suits 4 channel amplifiers
- Twisted pair RCA's with gold plated connectors
- Includes cable ties, wiring grommet & fitting terminals

PRODUCT CODE  
**72 BSX408**



**AERPRO  
AMP WIRING KIT  
2-CH 4GA 650W**

The kit will power up to 650W and includes everything you need to install a 4 channel amplifier into your vehicle.

- 650W amp wiring kit.
- 4 gauge.
- Suits 2 Channel Or monoblock amplifiers
- Twisted pair RCA's with gold plated connectors.
- Includes cable ties, wiring grommet & fitting terminals.

PRODUCT CODE  
**72 BSX204**



**AERPRO  
RCA Y SPLITTER  
1 FEMALE - 2 MALE**

All MAXCOR RCA's are double shielded and twisted pair to minimise the risk of signal interference and also feature gold plated connectors to minimise loss of signal.

- Double Shielded Twisted Pair
- Gold Plated Connectors
- Soft Touch Super Flex Cable

PRODUCT CODE  
**72 MX12**



**AERPRO  
RCA LEAD  
2 MALE - 2 MALE 1.2M**

MAXCOR RCA's are made from high quality components to ensure you receive blistering performance from your amplifier. All MAXCOR RCA's are double shielded and twisted pair to minimise the risk of signal interference and also feature gold plated connectors to minimise loss of signal.

- Double Shielded Twisted Pair
- Gold Plated Connectors
- Soft Touch Super Flex Cable
- 1.2M Length
- 2 Male to 2 Male Connectors

PRODUCT CODE  
**72 MX120**



**AERPRO  
RCA Y SPLITTER  
1 MALE - 2 FEMALE**

MAXCOR RCA's are made from high quality components to ensure you receive blistering performance from your amplifier. All MAXCOR RCA's are double shielded and twisted pair to minimise the risk of signal interference and also feature gold plated connectors to minimise loss of signal.

- 1 Male to 2 Female Connectors
- 18CM Length
- Double Shielded Twisted Pair
- Gold Plated Connectors
- Soft Touch Super Flex Cable

PRODUCT CODE  
**72 MX21**



**AERPRO  
RCA LEAD  
2 MALE - 2 MALE  
2.5M**

The RCA's are made from high quality components to ensure you receive blistering performance from your amplifier. All RCA's are double shielded and twisted pair to minimise the risk of signal interference and also feature gold plated connectors to minimise loss of signal.

- 2 male to 2 right angle male connectors.
- 2.5m length.
- Double shielded twisted pair.
- Gold plated connectors.
- Soft touch super flex cable.

PRODUCT CODE  
**72 MX255**



**AERPRO  
6.5 INCH 2-WAY  
IN-WALL/CEILING  
SPEAKERS**

The Studio Acoustics 6.5in 2-Way In-Wall/Ceiling Stereo Speakers are ideal for both home and commercial use and are perfect for background music, home theatre surround sound or room to room set-up.

- Sold as: Pair.
- Colour: White.
- Adjustable tweeter.
- Heavy duty mounting clips.

PRODUCT CODE  
**75 SA360W**



**AERPRO  
6.5 INCH 2-WAY  
IN-WALL/CEILING  
SPEAKERS- FRAMELESS**

The Studio Acoustics 6.5in 2-Way In-Wall/Ceiling Frameless Stereo Speakers are ideal for both home and commercial use and are perfect for background music, home theatre surround sound or room to room set-up.

- Sold As: Pair.
- Colour: White.
- Adjustable tweeter.
- Heavy duty mounting clips.
- Frameless magnetic grilles.
- 12dB Per-Octave crossover.

PRODUCT CODE  
**75 SA600WM**



**AERPRO  
2-WAY UNIVERSAL SPEAKERS**

The Studio Acoustics 4in 2-Way Indoor/Outdoor Universal Speakers are ideal for both indoor and outdoor environments around the home or commercial facilities such as offices, gyms, restaurants, hotels etc.

- Sold as: Pair.
- Weather resistant.
- ABS case. Aluminium grilles.
- Multi angle adjustable mounting brackets.

PRODUCT CODE  
**75 SA400B 3 INCH - BLACK**  
**75 SA400W 3 INCH - WHITE**  
**75 SA500B 4 INCH - BLACK**  
**75 SA500W 4 INCH - WHITE**



**AERPRO  
RCA LEAD  
2 MALE - 2 MALE  
5.5M**

The RCA's are made from high quality components to ensure you receive blistering performance from your amplifier. All RCA's are double shielded and twisted pair to minimise the risk of signal interference and also feature gold plated connectors to minimise loss of signal.

- 5.5M - 2 male to 2 male connectors.
- Double shielded twisted pair.
- Gold plated connectors.
- Soft touch super flex cable.
- 5.5M length.

PRODUCT CODE  
**72 MX550**



**AERPRO  
RCA LEAD  
2 MALE-2 MALE  
RIGHT ANGLE  
5.5M**

All MAXCOR RCA's are double shielded and twisted pair to minimise the risk of signal interference and also feature gold plated connectors to minimise loss of signal.

- Double Shielded Twisted Pair
- Gold Plated Connectors
- Soft Touch Super Flex Cable

PRODUCT CODE  
**72 MX555**



**AERPRO  
RCA LEAD 2 MALE TO  
3.5MM STEREO**

The RCA lead 2 male to 3.5MM stereo is suitable for connection between your computer, MP3, VCD, DVD, HDTV, CD player, etc. and amplifier or speaker. The cable provides sharp and clear sound for your speakers.

- Anodised aluminium plugs.
- Heavy duty nylon sheath.
- 1.5m length.

PRODUCT CODE  
**72 ADM2R35A**



**AERPRO  
PREMIUM TWO SPEAKER  
WALL PLATE**

Accommodates two speaker connections. The binding posts accept bare speaker cable or banana plugs and are ideal for professional indoor speaker installations.

- Sold as: Single.
- Colour: White.
- Four heavy duty metal binding posts (Red and black pair).
- Standard NZ/Australian size wall plate.
- Suits bare speaker wire or banana plugs.
- Mounting screws included.

PRODUCT CODE  
**75 SA4BJM**



**AERPRO  
4 PREMIUM  
BANANA PLUGS**

The Studio Acoustics Premium Banana Plugs are gold plated metal and are designed for mid to large speaker cable. They have an entry hole on the side with a screw down point allowing the plug to be secured to the plug.

- Sold As: Four (2 Red, 2 Black).
- Colour: Gold (Red/Black Indicator).
- Metal Housing.
- Gold Plated.
- Suits Mid To Large Cable, 16-12 AWG.

PRODUCT CODE  
**75 SA822M**



**AERPRO  
SILICONE SPEAKER CABLE**

Studio Acoustics Silicone Speaker Cable delivers high quality audio to your speakers, ensuring super clarity and maximum volume. It utilises a flexible silicone sheath allowing the cable to neatly wrap around tight corners.

- Silicone coated.
- Very flexible.
- Extremely durable.
- Indoor and outdoor use.

PRODUCT CODE  
**75 SA1406 14GA - 6M**  
**75 SA1430 14GA - 30M**  
**75 SA1630 16GA - 30M**  
**75 SA1806 18GA - 6M**  
**75 SA1830 18GA - 30M**



**AM-FM STEREO EARMUFFS**

Allows you to listen to music, your favourite sports team or talk radio show. The adjustable headband provides the user with superior comfort while hearing protection equipment keeps all sounds above 20dB out.

- Adjustable headband with comfortable ear pads.
- Rotary volume and tuning controls.
- AM/FM Radio.
- Operated by 2xAAA batteries (not included).
- Hearing protection equipment to block 20 dB+.

PRODUCT CODE  
**47 ABA330S**



## INTERIOR ACCESSORIES

Jelly Jets Air Freshener .....	106
Wildcat Leaf Air Freshener .....	108
Hot Wheels Air Freshener .....	109
Little Joe Air Freshener .....	110
Michelin Air Freshener .....	111
Sphere Air Freshener .....	111
All Blacks Air Freshener .....	111
Wireless Phone Chargers .....	112
USB Connectivity .....	113
Phone Holders .....	114
Trim Kits .....	115
Vinyl Wrap .....	115
Pedal Pads .....	116
Gauges .....	117
Gear Knobs .....	118
Gear Boot .....	119
Sunshades .....	120
All Blacks Sunshade .....	121
Caterpillar Sunshade .....	121
R.M. Williams Sunshade .....	121
Steering Wheel Locks .....	122
Security Cable Lock .....	122
Boot Organizer .....	123
Pet Seat Protector .....	123
Oscillating Fan .....	123
Steering Wheel Spinner .....	123
L-Plate .....	123
Drink Holder .....	123

# A NEW FEELING IN THE AIR

Every fruit has a hidden scent, that refreshing burst of freshness we can't always explain.

What if you could trap those refreshing burst of flavours, that special wisp that every fruit gives when you cut into it?

At Jelly Jets, we've made it our mission to trap that freshness and turn it into something that lasts.

**JELLY JETS®**  
— AIR FRESHENER —



All our nine jet-shaped scents will leave your rides and homes smelling unbelievably delightful. Each jet shaped air freshener is made with love and meticulousness. Each of them has its own fresh and fruity element. If you love the flavour, then you'll love the scent!

[www.jellyjets.co.nz](http://www.jellyjets.co.nz)

**JELLY JETS  
CLIP-IT AIR FRESHENER**

We are continuously looking for ways to capture the scent and bring it into your homes, offices, caravans, boats and RVs. Our exciting flavours gradually fill the room and take over your space in an enticing way; with many different fragrances to choose from.

- Iconic jet shaped air freshener.
- Fragrance lasts up to 45 days.
- Easily clips onto car vent.
- Scratch and smell before you purchase.
- Ideal for your car, home, office, caravan, RV or boat.

- PRODUCT CODE
- 52 JJC001 BUBBLE GUM
  - 52 JJC001S BUBBLE GUM SPARKLE
  - 52 JJC002 CHERRY
  - 52 JJC002S CHERRY SPARKLE
  - 52 JJC003 BLUEBERRY
  - 52 JJC003S BLUEBERRY SPARKLE
  - 52 JJC005 VANILLA
  - 52 JJC005S VANILLA SPARKLE
  - 52 JJC006 STRAWBERRY

**JELLY JETS  
CLIP-IT ASSORTED AIR FRESHENER  
PACK OF 12**

- PRODUCT CODE
- 52 JJC12ASST

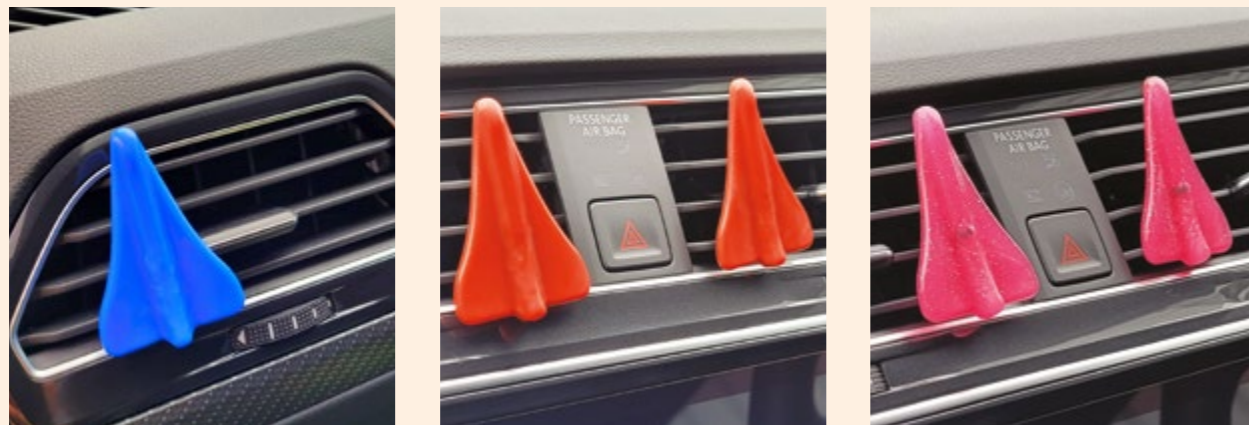

**JELLY JETS  
HANG-IT AIR FRESHENER**

We are continuously looking for ways to capture the scent and bring it into your homes, offices, caravans, boats and RVs. Our exciting flavours gradually fill the room and take over your space in an enticing way; with many different fragrances to choose from.

- Iconic jet shaped air freshener.
- Fragrance lasts up to 45 days.
- Hangs from your rear vision mirror.
- Scratch and smell before you purchase.
- Ideal for your car, home, office, caravan, RV or boat.

- PRODUCT CODE
- 52 JJH001 BUBBLE GUM
  - 52 JJH002 CHERRY
  - 52 JJH003 BLUEBERRY
  - 52 JJH004 GREEN APPLE
  - 52 JJH005 VANILLA
  - 52 JJH006 STRAWBERRY
  - 52 JJH007 ORANGE
  - 52 JJH008 LEMON
  - 52 JJH009 BANANA

**JELLY JETS  
HANG-IT ASSORTED AIR FRESHENER  
PACK OF 12**

- PRODUCT CODE
- 52 JJH12ASST

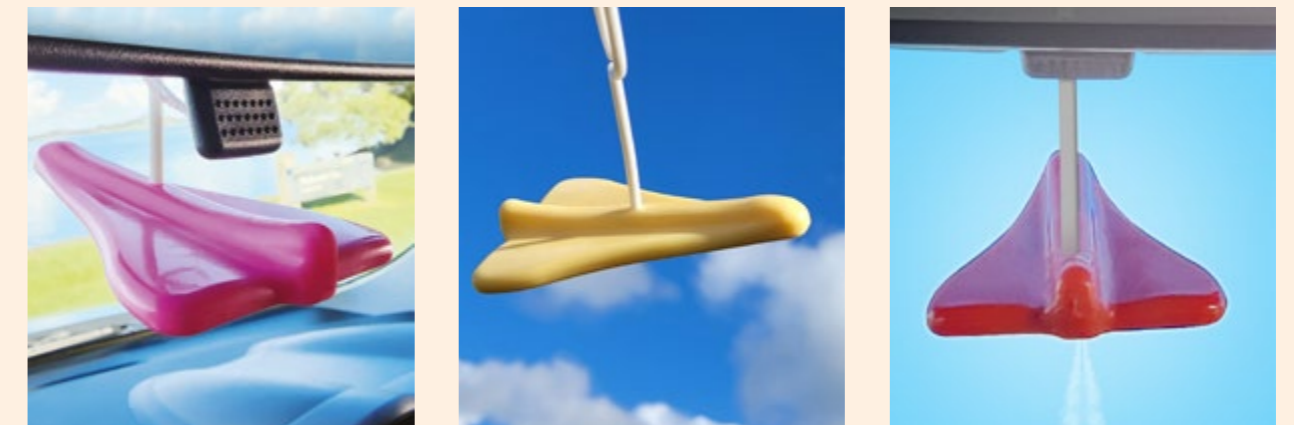

**WILDCAT  
LEAF AIR FRESHENER**

This air freshener provides long lasting fragrances for cars, boats, offices and homes. This visually unique product will solve your odour problems as the natural fragrance makes the air smell fresh.

- For car, boat, office or home.
- Supplied with elastic cords for easy hanging.

- PRODUCT CODE
- 52 LEAF11 BLACK MAGIC
  - 52 LEAF11-3 BLACK MAGIC – 3 PACK
  - 52 LEAF13 VANILLA
  - 52 LEAF13-3 VANILLA – 3 PACK
  - 52 LEAF15 GREEN APPLE
  - 52 LEAF17 STRAWBERRY
  - 52 LEAF17-3 STRAWBERRY – 3 PACK
  - 52 LEAF18 OUTDOOR BREEZE
  - 52 LEAF18-3 OUTDOOR BREEZE – 3 PACK
  - 52 LEAF19 WILDBERRIES
  - 52 LEAF19-3 WILDBERRIES – 3 PACK
  - 52 LEAF20 MOUNTAIN PINE



**WILDCAT  
HIDE IT AIR FRESHENER**

This premium under seat air freshener has a long lasting fragrance that freshens up your car, home, office or boat. The under seat type of air freshener removes bad odours and can be concealed under any seat perfectly.

- Long lasting fragrance.
- For car, boat, office or home.
- Under seat fragrance sachets.

- PRODUCT CODE
- 52 HIDEIT11 BLACK MAGIC
  - 52 HIDEIT13 VANILLA
  - 52 HIDEIT17 STRAWBERRY
  - 52 HIDEIT18 OUTDOOR BREEZE
  - 52 HIDEIT19 WILDBERRIES



**WILDCAT  
LEAF 7 X 6 ASSORTED  
AIR FRESHENERS PK42**

- PRODUCT CODE
- 52 LEAF42ASST

**WILDCAT  
HIDE IT 5 X 3 ASSORTED AIR  
FRESHENERS PK15**

- PRODUCT CODE
- 52 HIDE15ASST



**HOT WHEELS  
AIR FRESHENER 3D HANGING**

Hot Wheels has developed in partnership a range of automotive inspired air fresheners that can be enjoyed in the car, office, and home. Take your favourite Hot Wheels fragrances anywhere and have your vehicle smelling extra fresh.

- Authentic colour-coded hot wheels rim design.
- Two-sided design - EVA blended polymer.
- Signature hanging hook for multiple locations.
- Lasts up to 30 days.

- PRODUCT CODE
- 52 AF532320F REDLINE
  - 52 AF532321F BURNOUT
  - 52 AF532322F TREASURE HUNT
  - 52 AF532323F BEACH BOMB
  - 52 AF532324F RODGER DODGER
  - 52 AF532325F SILVER BULLET



**HOT WHEELS  
AIR FRESHENER VENT**

Hot Wheels has developed in partnership a range of automotive inspired air fresheners that can be enjoyed in the car, office, and home. Take your favourite Hot Wheels fragrances anywhere and have your vehicle smelling extra fresh.

- Authentic colour-coded hot wheels rim design.
- Dynamic air flow design improving fragrance delivery.
- 360-degree vent mount design.
- Lasts up to 30 days.

- PRODUCT CODE
- 52 AF532326F REDLINE
  - 52 AF532327F BURNOUT
  - 52 AF532328F TREASURE HUNT
  - 52 AF532329F BEACH BOMB
  - 52 AF532330F RODGER DODGER



**HOT WHEELS FRAGRANCES**

- **Redline** – a combination of orange bergamot, cedar and leather.
- **Burnout** – a woody combination of pine needle and sandalwood.
- **Treasure Hunt** – a combination of pineapple, caramel and raspberry.
- **Beach Bomb** – a combination of raspberry, peach and cedar.
- **Rodger Dodger** – a combination of ocean spray, orange and vanilla.
- **Silver Bullet** – a combination of leather, sandalwood and cedar.



**LITTLE JOE AIR FRESHENER**

The Little Joe car vent air freshener is designed with a clip that enables the scented Little Joe character to be fitted to any A/C air vent to release fragrance uniformly into a car for long lasting freshness.

- Fragrance lasts 45 days.
- Easy install – just clips to the cars vent.

PRODUCT CODE  
**52 LJMB001** VANILLA  
**52 LJMB002** NEW CAR  
**52 LJMB003** FRUIT PASSION  
**52 LJMB004** CHERRY  
**52 LJMB007** OCEAN SPLASH



**LITTLE JOE 3D VENT MEMBRANE AIR FRESHENER**

The Little Joe car vent air freshener is designed with a clip that enables the scented Little Joe character to be fitted to any A/C air vent to release fragrance uniformly into a car for long lasting freshness.

- Little Joe is a cute 3D character that smells great.
- Fragrance lasts 45 days.
- Easy installation - just clips to the cars vent.

PRODUCT CODE  
**52 LJMEM02** NEW CAR  
**52 LJMEM04** CHERRY  
**52 LJMEM06** BLACK VELVET



**LITTLE JOE 3D VENT CHARACTER SWEET AS NEW CAR AIR FRESHENER**

The Little Joe car vent air freshener is designed with a clip that enables the scented Little Joe character to be fitted to any A/C air vent to release fragrance uniformly into a car for long lasting freshness.

- Fragrance lasts 45 days.
- Easy installation - just clips to the cars vent.

PRODUCT CODE  
**52 LJOK02N**



**SPHERE 3D VENT SPHERE AIR FRESHENER**

Sphere Car Air Fresheners are uniquely designed with grid like inclusions and a round shape that perfectly align with the flow of the air conditioner inside a vehicle. The fragrance released is extremely effective in achieving a pleasant smell throughout the vehicle.

- Unique and modern design.
- Grid shape for better fragrance distribution.
- 360 degree swivel.
- Stronger and longer lasting smell.

PRODUCT CODE  
**52 SPE001** LEMON  
**52 SPE003** OCEAN SPLASH  
**52 SPE005** FRUIT BLAST



**ALL BLACKS OCEAN BREEZE AIR FRESHENER**

Improve the freshness of your car with this New Zealand All blacks air freshener. The air freshener is easy to install as you just need to clip it to the air vent. For use in car, boat, office or home.

- Long lasting Ocean Breeze fragrance.
- Single pack.

PRODUCT CODE  
**52 ABRJ015**



**MICHELIN AIR CONDITIONING SYSTEM CLEANER CLEAN AIR 150ML**

Michelin Clean Air is an easy-to-use interior spray for cleansing the AC system of automobiles. This easy-to-use interior care spray inhibits any foul odours and cleanses the vents and the AC of your vehicle leaving behind a refreshing Arctic fragrance.

- No tools required.
- Fragrance: Arctic.
- 15 minutes start to finish.
- Neutralises bad odours.
- 150ml.

PRODUCT CODE  
**52 31449**



**MICHELIN 3D VENT AIR FRESHENER OCEAN FRESH**

This Michelin Man air freshener is designed exclusively for attaching to the vehicle's air vent blades.

- In the shape of the iconic Michelin Man (Bibendum).
- Designed exclusively for attaching to the vehicle air vent blades.
- Long lasting Ocean Fresh fragrance.
- .

PRODUCT CODE  
**52 32040**



**MICHELIN TIRE CAN AIR FRESHENER VANILLA 48G**

MICHELIN Vanilla air freshener for your car. With Fragrance control, it is ideal for use in the home, car and office.

- Easy to use.
- Ideal for home, office or car.
- Long lasting vanilla fragrance.
- Fragrance control.

PRODUCT CODE  
**52 87800**



**AERPRO WIRELESS QI ENABLED ANTI SLIDE SILICONE CHARGING PAD**

Aerpro AP10QI anti-slide wireless charging pad for home or car use works well with Qi-enabled hand-held devices such as Samsung or Apple, among others. It also sports a non-slip charging base.

- Universal pad mount can be placed on flat surface.
- 10W fast charging.
- Maximum phone size 90mm wide x 175mm high.
- Ideal for use in cars, at home or even in the office.
- Non-slip, anti-skid and non-scratch rubber surface.

PRODUCT CODE  
**50 AP10QI**



**AERPRO WIRELESS PHONE CHARGER QI-ENABLED - TOYOTA HILUX 2015 ON**

Seamlessly blends in with the vehicle interior.

- Perfect accessory for Toyota Hilux 2015-on vehicles with automatic transmission.
- Qi Certified with up to 15W Fast Charging.
- Charge indicator light shows the charging status of the device.
- Anti-skid rubber finish for secure mounting of the smartphone.

PRODUCT CODE  
**50 AWCTO1**



**AERPRO SUPER SLIM 15W QI WIRELESS CHARGING PAD**

Aerpro AP15QIW brings together charging convenience, accessibility and efficiency into one single slim wireless charging solution. Designed for home or in-car use, this Qi-enabled charging pad is clad in rubber finish to avoid any possible device slippage at all times.

- 15W Qi fast-charging super slim wireless charging pad.
- Suitable for all wireless Qi-enabled gadgets like Samsung S7, S8, S9, S10 or Apple iPhone8, iPhone8 Plus, iPhone X, etc.
- Automatically identifies charging protocols to deliver the fastest wireless charge possible.
- Non-slip wireless charging surface to ensure phone securely stays placed over charging point.
- Charge indicator light to show when the phone is charging and when charging is complete.
- Anti-skid rubber finish perfect for home, office or car use.
- Multi-protect over voltage and temperature protection.
- Comes with a 1-metre Micro USB cable that can be connected to a USB charge port.

PRODUCT CODE  
**50 AP15QIW**



**AERPRO 10W QI ENABLED WIRELESS CHARGING SMARTPHONE HOLDER**

Take in-vehicle wireless charging to the next level with this universal adhesive, suction, and vent mount wireless charging smartphone holder. Delivers the fastest charge rate possible.

- Qi Certified 10W / 7.5W Qi Fast Charging automatically identifies charging protocols to deliver fast wireless charging for the device.
- Includes adhesive dash mount, air vent mount and gel suction mount, allowing the holder to be mounted virtually anywhere in the vehicle.
- Sliding charging coil increases charging efficiency by 20% by allowing perfect alignment with smartphone.
- Supports 60mm to 90mm wide smartphones.
- Safety protocols detect and prevent any unsafe charging occurrence to avoid damage to the smartphone.
- Convenient smartphone mounting with a touch sensor for opening and automatic close function.
- Also features a manual touch button with release and lock function.
- Foldable foot stand & 360 degree rotation enables the smartphone to be positioned vertical or horizontal.
- Charge indicator light shows the charging status.
- **50 AP20AQI** includes 1.2m Type C USB cable which simply connects to a USB port in the vehicle.
- **50 AP20AQIC** includes QC3.0 USB vehicle accessory socket charger (pictured) and 1.2m USB cable suitable for use in 12v & 24v vehicles.

PRODUCT CODE  
**50 AP20AQI**  
**50 AP20AQIC INCL. CHARGER**



**AERPRO QI ENABLED 15W CUP HOLDER SMARTPHONE MOUNT WIRELESS CHARGER**

Take your in-vehicle wireless charging experience to the next level with this cup holder wireless smartphone charger. Thanks to its 15W Qi-Certified wireless charging capabilities, it delivers the fastest charge rate possible.

- Qi Certified 15W Qi Fast Charging automatically identifies charging protocols to deliver fast wireless charging for the device.
- 3 Coil wireless charging provides a wider charging area and vertical inductive distance.
- Universal fit rubber base allows the holder to securely mount in the vehicle cup holder (60-90mm).
- Includes QC3.0 USB port, allowing other devices to connect and charge via the holder.
- Over voltage and temperature protection protocols detect and prevent any unsafe charging occurrence to avoid damage to the smartphone.
- Convenient smartphone mounting, simply sit the compatible smartphone on the holder and it will begin charging.
- 12V Accessory plug with 43cm lead will connect to any vehicle accessory socket to provide power to the holder.
- Charge indicator light shows the charging status of the connected device.

PRODUCT CODE  
**50 APDCCUP**



**AERPRO 5W QI WIRELESS CHARGER & 5000MAH POWER BANK**

AP5000WC automatically recognises charging protocols to deliver the fastest charging time possible. Even better, it comes with a non-slip suction cup that secure your smartphone making it ideal for use at home, in the car and on the go.

- Charge your wireless smartphone directly from the powerbank with no cables needed.
- 5W Qi certified wireless charging output for quick charge.
- USB charge port for non wireless phone charging & includes 30cm micro USB cable.
- 5000mAh battery capacity provides plenty of reserve power to keep your smartphone charged on the move.
- Suitable for all wireless Qi-enabled gadgets like Samsung S7, S8, S9, S10 or Apple iPhone8, iPhone8 Plus, iPhone X, etc.
- Automatically identifies charging protocols to deliver fastest, most efficient wireless charge possible.
- Equipped with over voltage and temperature protection to protect your smartphone.
- Light up power indicator to show how much power is left in the powerbank.
- Suction cup base secures phone making it ideal for home use, in-car use or on the go.

PRODUCT CODE  
**50 AP5000WC**



**AERPRO CHARGER 3-WAY 12/24V DC LED SOCKET POWER CENTRE**

This cigarette lighter adapter/USB car charger is an essential gadget for your vehicle. It fits most 12V car power sockets, and offers a convenient way to use portable appliances and charge your electronics while you drive.

- Converts 12V outlet into three 12V outlets.
- Output 10 amp .

PRODUCT CODE  
**50 APL3**



**AERPRO CHARGER 3-WAY 12/24V SOCKETS WITH USB PORT POWER CENTRE**

This device converts a 12V outlet into 3 x 12V outlets and 2 x USB for your car. This allows the user to charge or use multiple electronic devices at the same time while driving.

- Triple 12/24V DC sockets with 1.2A USB Port.
- Output USB 1.2 Amp.
- Charges smartphone, iPod, digital camera.
- Blue LED illumination.
- Allowing for connection and charging of multiple 5V+12V DC Devices.
- Max 5.0A per each individual socket.
- 10A Fused for protection.

PRODUCT CODE  
**50 APL3USB**



**AERPRO CHARGER 3 USB PORT 4A POWER CENTRE**

Convert your car's cigarette lighter into two USB ports with this useful power centre. Charge your laptops, smartphones, GPS etc. on the go while driving. Do not let low battery ruin your day again.

- Converts 12V outlet into three USB.
- Charges smartphone, iPod, digital camera, tablets.
- Output USB 5.2amp.

PRODUCT CODE  
**50 APL30USB**



**AERPRO CHARGER 5 USB PORT POWER CENTRE**

This USB power centre, with 5 USB ports can be used to charge your electronic devices while driving your car. This device charges smartphones, tablets etc. This USB power centre is made for your convenience while driving.

- Converts 12V outlet into five USB outputs.
- Charges almost any mobile device.
- Twin USB output on plug 2.4A shared.
- Triple USB output 2.4A each.
- 1.8m cable.

PRODUCT CODE  
**50 APL50USB**



**AERPRO DUAL USB CAR CHARGER**

The USBM221 is perfect for charging mobile devices in your vehicle. A compact plug with 2 USB charging ports and a max output of 3.1A gives you the power to charge almost any mobile device.

- Dual voltage input 12V or 24V.
- Suits most smartphones and tablets.
- Blue LED illumination.
- Smart IC for optimized charging.

PRODUCT CODE  
**50 USBM221**



**AERPRO TRIPLE USB CHARGER**

The APL48S is a triple USB port charger with Smart IC suitable for all kinds of smart phones and tablets. Smart IC detects device and optimises charge, reducing charging time and extending battery lifespan.

- Suitable for all smart phones and tablets.
- Triple USB car charger.
- Smart IC fast charging.
- Blue LED power indicator.

PRODUCT CODE  
**50 APL48S**



**AERPRO  
MAGNETIC ADHESIVE  
DASH MOUNT**

Our universal magnetic dash mobile cell phone car mount works with many different smartphones & GPS accessories. The magnetic adhesive makes sure that your device really sticks.

- Contour adhesive mount suits almost any surface.
- 360-degree rotating head.
- Locking knob secures magnetic head angle.
- Includes 1 x large and 1 x small metal plate.

PRODUCT CODE  
**50 APMDASH**



**AERPRO  
STRONG MAGNETIC  
SUCTION MOUNT**

Firmer grip of smartphones, tablets, GPS or other devices as you drive, APSMSHLD is armed with six powerful neodymium magnets.

- MagMate Pro super strong magnetic suction mount.
- 50% stronger than our previously released MagMate Series.
- Surface mountable with gel pad suction mount and locking suction base.
- Safely attaches phone to the windscreen, dash or other flat surface.
- Equipped with six powerful neodymium magnets for superior grip.
- Sports a 360-degree adjustable rotating head.
- Lets you use your phone for navigation or communication as you drive.
- Great for car, 4WD, truck, home or even office use.

PRODUCT CODE  
**50 APSMSHLD**



**AERPRO  
LOCKING AIR VENT MOUNT  
MAGNETIC HOLDER**

The APMVLOK premium vent mount will securely hold your mobile device in place without the need for spring-loaded brackets or sticky gel pads. MagMate mounts feature powerful rare-earth magnets that are 30% stronger than the competition.

- Powerful strong-hold rare-earth magnets.
- 360-degree rotating head.
- Locking grips for thick or thin vents.
- Adjustable magnetic head angle.

PRODUCT CODE  
**50 APMVLOK**



**AERPRO  
STRONG MAGNETIC VENT  
MOUNT**

Secures smartphones or other devices to your vehicle's vent. It's also equipped with six powerful neodymium magnets that keep your handheld gadget in place.

- MagMate Pro super strong magnetic vent mount.
- 50% stronger than our previously released MagMate Series.
- Adjustable padded clamping grips for secure, impeccable hold.
- Sports a 360-degree adjustable rotating head.
- Lets you use your phone for navigation or communication as you drive.
- Great for car, 4WD or truck.

PRODUCT CODE  
**50 APSMVLOK**



**AERPRO  
MAGNETIC WINDSCREEN  
MOUNT**

The holder attaches securely to any flat surface. Attach the metal plate securely to the back of your device or place it between the device and it's cover. Then simply snap it to the magnetic disc of the holder.

- Powerful strong-hold rare-earth magnets.
- 360-degree rotating head.
- Strong suction cup for a secure hold.
- Locking knob secures magnetic head angle.
- Includes 1 x large and 1 x small metal plate.

PRODUCT CODE  
**50 APMWSHLD**



**AERPRO  
REPLACEMENT METAL  
PLATES 3PK**

Got a new phone or case? No need to buy a mount! MagMate Plates are now available separately. MagMate Plates can be applied directly to the device, between the phone and the case or to the exterior of the case.

- Each plate is fitted with high-quality 3M brand adhesive.
- 3 different sizes in a pack, small, medium and large.

PRODUCT CODE  
**50 APM3RP**



**AERPRO  
STRONG MAGNETIC DASH  
MOUNT**

APSMMDASH Magnetic Dash Mount brings stability and security to the table, with convenience in tow. Enables for stronger grip of your smartphone or other devices and is equipped with six powerful neodymium magnets that hold your device steady.

- MagMate Pro super strong magnetic dash mount.
- 50% stronger than our previously released MagMate Series.
- Comes with 3M brand adhesive for excellent, secure hold on any flat surface.
- Equipped with 6 powerful neodymium magnets for superior grip.
- Ideal for mounting smartphones, tablets, GPS devices, among others.
- Sports a 360-degree adjustable rotating head.
- Securely adjust angle via a robust locking knob.
- Lets you use your phone for navigation or communication as you drive.
- Great for car, 4WD, truck, home or even office use.

PRODUCT CODE  
**50 APSMDASH**

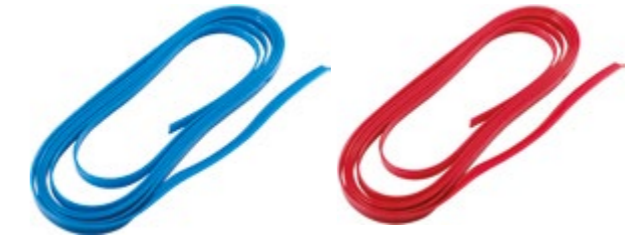

**TYPE S  
INTERIOR TRIM KIT 3M**

Add some style to the inside of your vehicle with the Interior Accent Strip. The flexible, UV resistant PVC material bends to form along the contours of your dash or door side panelling.

- Includes 3m trim to fit PVC strip.
- V-lock design for secure installation.
- Bends around corners.

PRODUCT CODE  
**17 AC56056 BLUE**  
**17 AC56216 RED**



**TYPE S  
WRAP 30.5CM X 91CM**

Designed to withstand the elements, these professional grade vinyl adhesives will guard against harsh UV rays and cover unsightly scratches or blemishes. Non-visible air release channels on the bottom of the film allow air to be released during installation, eliminating bubbles.

- Professional grade vinyl material.
- Pressure activated bonding allows repositioning for hassle free installation.
- Air release channels eliminate bubbles and air pockets.
- Durable, long lasting protection from scratches and UV rays.
- Package contains one 30.5cm x 91cm roll.

PRODUCT CODE  
**17 AC54783 BLACK**  
**17 AC54778 CARBON FIBRE**



**WILDCAT  
CARBON BLACK  
MANUAL PEDAL KIT**

Looking to upgrade and enhance your car pedals? Try out these pedals for a stylish edgy look. The pedals are easy to fit and are of high quality.

- Manual pedal pad kit.
- Matte black alloy and carbon fibre look inserts.
- Pads to fit existing pedals.
- Easy to follow fitting instructions supplied.

PRODUCT CODE  
**44 P20457MBL**



**WILDCAT  
GT MANUAL  
PEDAL PADS**

The Wildcat GT manual transmission set of pedal pedals consists of accelerator, brake pedal and clutch pedal. These premium pedals are made of a high-quality alloy and features a sporty black colour.

- Mounts securely over factory pedals.
- Universal design fits most cars.
- Sporty black look.
- Made of a premium alloy.

PRODUCT CODE  
**44 P8543B**



**WILDCAT  
RACE MANUAL  
PEDAL PADS**

The Wildcat Race manual transmission set of pedal pedals consists of accelerator, brake pedal and clutch pedal. Made of a high-quality alloy and is durable and wear resistant. Feature a non-slip sporty chrome colour.

- Mounts securely over factory pedals.
- Universal design fits most cars.
- Sporty chrome look.
- Made of a premium alloy.

PRODUCT CODE  
**44 P857B**



**WILDCAT  
CARBON BLACK  
AUTO PEDAL KIT**

Give your automatic transmission car a more sporty and stylish feel with this pedal kit. The pedal kit is constructed from matt black alloy and carbon fibre look inserts making them superior in quality.

- Auto pedal pad kit.
- Matt black alloy and carbon fibre look inserts.
- Pads to fit existing pedals.
- Easy to follow fitting instructions supplied.

PRODUCT CODE  
**44 P20458ABL**

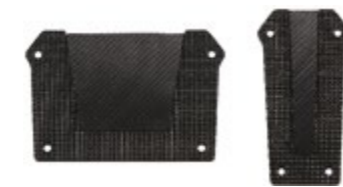

**WILDCAT  
GT AUTOMATIC  
PEDAL PADS**

The Wildcat GT automatic transmission set of pedal pedals consists of accelerator and brake pedals. These premium pedals are made of a high-quality alloy and are durable and wear resistant. The pedal pads feature a non-slip sporty black colour.

- Mounts securely over factory pedals.
- Universal design fits most cars.
- Sporty black look.
- Made of a premium alloy.

PRODUCT CODE  
**44 P8544B**



**WILDCAT  
RACE AUTOMATIC  
PEDAL PADS**

The Wildcat Race automatic transmission set of pedal pedals consists of accelerator and brake pedals. These premium pedals are made of a high-quality alloy and is durable and wear resistant. The pedal pads feature a non-slip sporty chrome colour.

- Mounts securely over factory pedals.
- Universal design fits most cars.
- Sporty chrome look.
- Made of a premium alloy.

PRODUCT CODE  
**44 P856B**



**WILDCAT  
WATER TEMPERATURE  
GAUGE 52MM**

For all water cooled engines, this gauge can alert you about a higher or lower than normal water temperature reading, to protect you while driving.

- Sweep: 270 degree.
- Dual temp range: 38-121 C and 100-250 F.
- Back light.
- Fitting kit and mount panel supplied.

PRODUCT CODE  
**42 1102S**



**WILDCAT  
ELECTRICAL  
FUEL LEVEL GAUGE 52MM**

The electrical fuel level gauge is used to measure the fuel level of an automobile.

- Diameter: 52mm.
- Sweep: 60 degree.
- Back light.
- Complete with tank unit for 5-27 inch tanks.
- Fitting kit and mount panel supplied.

PRODUCT CODE  
**42 EGF**



**WILDCAT  
OIL PRESSURE GAUGE  
52MM**

Monitor your engine temperature with precision using this oil pressure gauge. The gauge displays your truck's oil pressure levels from 0 to 80 PSI which allows you to closely monitor your engines oil pressure, in real time.

- Sweep: 270 degree.
- Dual pressure range: 0-80psi, 0-5.6kg.
- Back light.
- Fitting kit and mount panel supplied.

PRODUCT CODE  
**42 1103S**



**WILDCAT  
ELECTRICAL  
VOLTMETER GAUGE 52MM**

This voltmeter helps you keep an eye on battery voltage maintenance of the battery to prevent accidents caused by battery problems. Timely grasp the state of your battery between full charged and discharged.

- Diameter: 52mm.
- Sweep: 8-16 V and 60 degree.
- Fitting kit and mount panel supplied.
- Back light.

PRODUCT CODE  
**42 EGV**



**WILDCAT  
OIL PRESSURE GAUGE  
NYLON TUBE KIT**

This oil pressure nylon tube kit gauge from Trisco consists of the tube and fittings to suit Trisco oil pressure gauge.

- Nylon tube.

PRODUCT CODE  
**42 AG307**



**WILDCAT  
OIL PRESSURE GAUGE  
COPPER TUBE KIT**

This oil pressure copper tube kit gauge from Trisco consists of the tube and fittings to suit Trisco oil pressure gauge.

- Copper tube.

PRODUCT CODE  
**42 AG307C**



**WILDCAT  
ELECTRICAL  
OIL PRESSURE GAUGE  
52MM**

Oil pressure gauges are engineered to provide accurate readings measuring the pressure of oil circulating through the engine. The gauge is easy to hook-up and mount in your car and signals potential incorrect oil pressure, low oil level, defective oil pump and low oil level.

- Diameter: 52mm.
- Sweep: 0-7 kg and 60 degree.
- Back light.
- Fitting kit and mount panel supplied.
- Signals potential incorrect oil pressure, low oil level, defective oil pump and low oil level.

PRODUCT CODE  
**42 EGO**



**WILDCAT  
ELECTRICAL  
WATER TEMPERATURE  
GAUGE 52MM**

This water temperature gauge can be installed to measure either water or oil temperature. It can alert you, usually before the dash warning light would, to a problem that may cause a break down that would result in costly repairs.

- Diameter: 52mm.
- Sweep: 40-120 temp and 60 degree angle.
- Back light.
- Fitting kit and mount panel supplied.

PRODUCT CODE  
**42 EGT**



**WILDCAT  
ROUND BLACK TOP GEAR KNOB**

Give the interior of your car a more sporty look with this round black top gear knob. Constructed with lightweight materials to produce quick and spirited shifting making this a very quick and affordable upgrade for your car.

- Perforated vinyl and acrylic.
- Universal fit.
- Five adaptors to suit different gear shafts.

PRODUCT CODE  
**44 G1136A**



**WILDCAT  
TOURING GEAR SHIFT KNOB**

Wildcat's Touring Gear Shift Knobs have a modern sleek style and is made from high quality alloy that perfectly fits most vehicles but is specifically designed to fit cars and trucks with a manual 4, 5 or 6 speed transmission or a buttonless automatic transmission shift knob.

- Modern design.
- Ergonomic design.
- Easy to install.
- High quality alloy material.

PRODUCT CODE  
**44 G311BL**



**WILDCAT  
TURBO GEAR SHIFT KNOB  
WITH 4 SHIFT PATTERN DECALS**

Wildcat's Turbo Gear Shift Knobs have a modern sleek style and is made from high quality alloy that perfectly fits most vehicles but is specifically designed to fit cars and trucks with a manual 4, 5 or 6 speed transmission or a buttonless automatic transmission shift knob.

- Modern design.
- Ergonomic design.
- Easy to install.
- High quality alloy material.
- Includes 4 shift pattern decals.

PRODUCT CODE  
**44 G3411B**



**WILDCAT  
GT GEAR SHIFT KNOB  
WITH 4 SHIFT PATTERN DECALS**

Wildcat's GT Gear Shift Knobs have a modern sleek style and is made from high quality alloy that perfectly fits most vehicles but is specifically designed to fit cars and trucks with a manual 4, 5 or 6 speed transmission or a buttonless automatic transmission shift knob.

- Modern design.
- Ergonomic design.
- Easy to install.
- High quality alloy material.
- Includes 4 shift pattern decals.

PRODUCT CODE  
**44 G3597B**



**WILDCAT  
SKULL GEAR KNOB  
WITH LED LIGHT**

Tired of your regular stock gear knob? Then this might be the product for you. This skull gear knob has eyes that light up when activated. The skull is also a universal fit making it very easy and convenient to use.

- Batteries included.
- Eyes light up when activated.
- Five adaptors to suit different gear shafts.

PRODUCT CODE  
**44 G6020**



**WILDCAT  
BLACK SKULL GEAR KNOB**

Tired of your regular stock gear knob? Then this might be the product for you. This skull gear knob has eyes that light up when activated. The skull is also a universal fit making it very easy and convenient to use.

- Blue eyes.
- Universal fit.
- Five adaptors to suit different gear shafts.

PRODUCT CODE  
**44 G6021**



**WILDCAT  
NITRO GEAR SHIFT KNOB  
WITH 4 SHIFT PATTERN DECALS**

Wildcat's Nitro Gear Shift Knobs have a modern sleek style and is made from high quality alloy that perfectly fits most vehicles but is specifically designed to fit cars and trucks with a manual 4, 5 or 6 speed transmission or a buttonless automatic transmission shift knob.

- Modern design.
- Ergonomic design.
- Easy to install.
- High quality alloy material.
- Includes 4 shift pattern decals.

PRODUCT CODE  
**44 G3413G**



**WILDCAT  
BOOST GEAR SHIFT KNOB**

Wildcat's Boost Gear Shift Knobs have a modern sleek style and is made from high quality alloy that perfectly fits most vehicles but is specifically designed to fit cars and trucks with a manual 4, 5 or 6 speed transmission or a buttonless automatic transmission shift knob.

- Modern design.
- Ergonomic design.
- Easy to install.
- High quality alloy material.

PRODUCT CODE  
**44 G3520C**



**WILDCAT  
RACE GEAR SHIFT KNOB  
WITH 4 SHIFT PATTERN DECALS**

Wildcat's Race Gear Shift Knobs have a modern sleek style and is made from high quality alloy that perfectly fits most vehicles but is specifically designed to fit cars and trucks with a manual 4, 5 or 6 speed transmission or a buttonless automatic transmission shift knob.

- Modern design.
- Ergonomic design.
- Easy to install.
- High quality alloy material.
- Includes 4 shift pattern decals.

PRODUCT CODE  
**44 G3523S**



**WILDCAT  
CURVED BLACK GEAR KNOB**

The gear knob is designed to add style and function to the interior of your car. The shift knobs are constructed from durable long lasting materials and engineered to fit most shifter handles. If you are just driving to work, cruising or customizing your vehicle, this is the right shift knob for you.

- Leather look vinyl.
- Universal fit.
- Five adaptors to suit different gear shafts.

PRODUCT CODE  
**44 G6139**



**WILDCAT  
BLACK GEAR BOOT**

Give your vehicle a new look with this car shift gear cover. This car gear cover decorates car appearances, and makes your car particular and unique. The product is easy to install and can be done as part of a DIY project.

- Leather look cover.
- Universal fit.

PRODUCT CODE  
**44 GB7302**



**WILDCAT  
FRONT FOLDED SUPER THICK SUNSHADE**

This car window sunshade is suitable for a great variety of vehicles and efficiently insulates your car. It will keep your car interior cool and comfortable, help you prevent getting a hot steering wheel and protect you and your family from a hot car seat.

- Easy to pop open, and easy to fold.
- Damage-free installation, quick to install, directly install on front window.
- Extra thick
- Insulated and reflective foil.
- Protects, cools and blocks out UV rays.
- Accordion shade.

PRODUCT CODE  
**11 11616**



**WILDCAT  
FRONT FOLDED STANDARD SUNSHADE**

Our sunshades also act as a protector against damage from the sun's UV rays and helps you to maintain the appearance of your vehicle's upholstery. Easy installation and storage make this a great product to carry at all times in your vehicle.

- Suction cups to secure to glass.
- Accordion Shade.
- Protects, cools and blocks out UV rays.
- Front folding.

PRODUCT CODE  
**11 ISFS**



**WILDCAT  
FRONT FOLDED ULTRA JUMBO BUBBLE SUNSHADE**

Suction cups help to secure the sunshade to the glass. Protects, cools and blocks out UV rays.

- Dimensions: 1500mm x 740mm.

PRODUCT CODE  
**11 IJFSB1**



**WILDCAT  
SIDE TWIST MESH SUNSHADE PAIR**

The side twist sunshade helps you to keep your car cool and fresh while blocking out sunlight. A see through durable mesh gives you a quality product as well as an enjoyable view. Protects, cools and blocks out UV rays.

Two per pack - Dimensions: 440mm x 360mm.

PRODUCT CODE  
**11 TSMS**



**ALL BLACKS  
FRONT FOLDING SUNSHADE**

Show your support for the mighty All Blacks, with this sunshade. Not only will it help keep the sun's heat out of the car, it will protect the car interior upholstery from UV rays.

- High quality, double bubble accordion shade.
- Protects dashboard and upholstery.
- Keeps vehicle interiors cool.
- Dimensions: 1450mm x 650mm.

PRODUCT CODE  
**11 ABSS419**



**CATERPILLAR  
FRONT FOLDING SUNSHADE**

The Official CAT licensed Merchandise sunshade is perfect for the warmer summer months, reducing vehicle interior temperatures and protecting dashboards and steering wheels from sun wear and tear.

- Neotex 350gsm side panel fabric.
- Double bubble thickness for additional protection.
- Size: 68cm x 140cm.
- Reversible design.
- Fits most cars.
- Velcro strap for easy storage.

PRODUCT CODE  
**11 WSCATCHP**

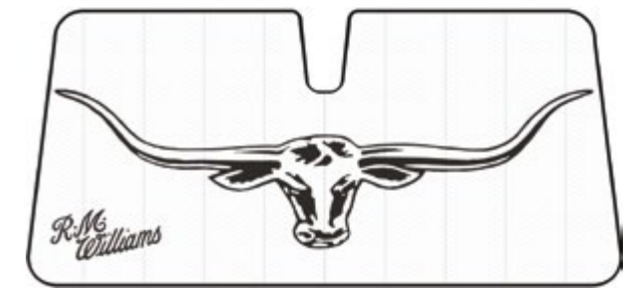

**R.M. WILLIAMS  
LONGHORN  
FRONT FOLDING SUNSHADE**

The Official R.M. Williams sunshade is perfect for the warmer summer months, reducing vehicle interior temperatures and protecting dashboards and steering wheels from sun wear and tear.

- Protects your car interior.
- Keeps your car cool.
- Fold away easily.
- Size: 68cm x 140cm.

PRODUCT CODE  
**11 WSRM17LH**



**WILDCAT  
DOUBLE HOOK  
STEERING WHEEL LOCK**

The steering wheel lock makes it impossible for your car to be stolen. This double hook steering wheel lock is made of heavy duty hardened steel, has a double bar hook for extra security and is self locking.

- Double bar, double hook, double security.
- Made of heavy duty hardened steel.
- Self-locking for easy installation.
- Highly visible to deter thieves.
- Vinyl coated to protect interiors from damage.

PRODUCT CODE  
**47 KSL12**



**PROLOCK  
STEERING WHEEL LOCK SS RED**

The Wildcat Prolock SS is an anti-theft device which easily locks onto your steering wheel for added security. The Prolock consists of a high security brass barrel lock and a unique cross key preventing the key from being duplicated.

- It is a highly visible deterrent - a potential thief will see the Prolock SS, and think twice before attempting to break into your vehicle.
- It is the 'Quiet Defender'. No false alarms.
- Prolock SS is easy to use. It can be fitted in seconds.
- Vinyl coated hooks protect your steering wheel.
- Up to \$1000 guaranteed rebate. Conditions apply.

PRODUCT CODE  
**47 PLSSR**



**PROLOCK  
STEERING WHEEL LOCK UNIVERSAL**

Wildcat Prolock physically prevents a thief from driving off in your vehicle. The 'press & click' lock allows you to securely lock the device without needing the key. The Prolock's high security brass barrel lock and unique key prevents key duplication.

- Easy 'press & click' locking system.
- Maximum security.
- Compact design.
- Safe integrated safety features.
- Saw and bolt cutter resistant.
- Up to \$1500 guaranteed rebate. Conditions apply.

PRODUCT CODE  
**47 PLUNI**



**WILDCAT  
SECURITY CABLE RESETTABLE COMBINATION LOCK 1.5M**

The combination lock security cable is easy to install and an ideal theft deterrent. The security lock code is resettable - making the product useful for a long period of time.

- High visual deterrence.
- Designed to protect various items around the home.
- Resettable combination lock.
- Vinyl coating protects the secured item from damage.
- Portable and easy to store.

PRODUCT CODE  
**47 CLD15**



**WILDCAT  
BOOT ORGANISER WITH COOLER BAG**

Wildcat's multifunctional boot organizer is an all-in-one storage solution for your vehicle. Constructed of premium materials, the whole organizer is durable and easy to be stored. With easily foldable design, the organizer is convenient to change into different sizes to meet your different needs.

- Ideal design to organise items in the boot of your car.
- Keeps your groceries, picnic supplies or camping gear secure.
- The cooler bag keeps your perishables cold and fresh.
- Mesh pockets all around for easy access to pack and store smaller items.
- Collapsible and compact when not in use.
- Size: (L) 55cm X (W) 35cm X (H) 30cm.

PRODUCT CODE  
**47 BOOTORG**



**WILDCAT  
PET SEAT PROTECTOR**

The Wildcat pet seat protector protects your car seats from your pet's dirty paws, stains, slobber and scuff marks. The pet seat protector can be fixed firmly on the back seat by adjustable buckle straps and features a non-slip bottom.

- Protects car seats from pet hair, dirt and drool.
- Easy to install easy to clean and easy to store.
- Scratch proof.
- Water-proof.
- Large activity space.
- Fits most cars.

PRODUCT CODE  
**47 PETSPP**



**WILDCAT  
ROUND 12V OSCILLATING FAN  
6 INCH 1 SPEED**

The oscillating automotive fan will make sure to cool off areas without the need to move it around constantly. The fan is quiet and durable, providing cool comfort for miles on the road.

- Complete with adjustable mounting bracket.
- Variable shift head oscillation mechanism.
- Ideal for use in cars, trucks, boats and 4WD.

PRODUCT CODE  
**47 YF612**



**TYPE S  
STEERING WHEEL SPINNER**

This device is designed to make steering effortless. Has a heavy duty clamp with cushion insert and fits most standard steering wheels.

- Black spinning knob with heavy duty clamp.
- Fits most steering wheels.
- Easy to install.

PRODUCT CODE  
**50 AC50092**



**WILDCAT  
STATIC CLING L PLATES PAIR**

With a complete static backing these "L" plates simply peel off and stick on as required without the need for an adhesive and is also great if you're learning in someone else's car.

- No need for adhesive.
- Pack of two.
- Leaves no mark on vehicles when removed.
- Easy To fit and remove. Complete static backing.

PRODUCT CODE  
**47 LPLATE**



**WILDCAT  
COLLAPSIBLE DRINK HOLDER**

Adjustable drink holder helps prevent spills and mounts quickly and easily in RVs, cars, vans, trucks as well as boats. This holder features arms that easily adjust to hold almost any size bottle, can or mug.

- Ideal for marine and caravan use.
- Screw or clip-on.
- Stainless steel screws supplied.
- Folds flat when not in use.

PRODUCT CODE  
**50 DH11089**



## WORKSHOP CONSUMABLES

Big Wipes .....	126
J-B Weld Epoxies & Adhesives .....	127
Quicksteel Epoxy.....	138
Tee-Kay Head Check.....	138
K-Seal Leak Repair .....	139
Gumout Additives .....	140
Slick 50.....	143
Dri Lube Stick.....	143
Pod Air Filters .....	144
Oil Breather Filter.....	144
Pod Air Filter Adaptors .....	145
Parts & Accessories.....	146
Bonnet Cables .....	146
Inspection Camera.....	146
Oil Filter Wrench .....	146
Oil Catch Tank .....	146
Radiator Overflow Recovery Unit.....	146
Assortments Packs.....	147

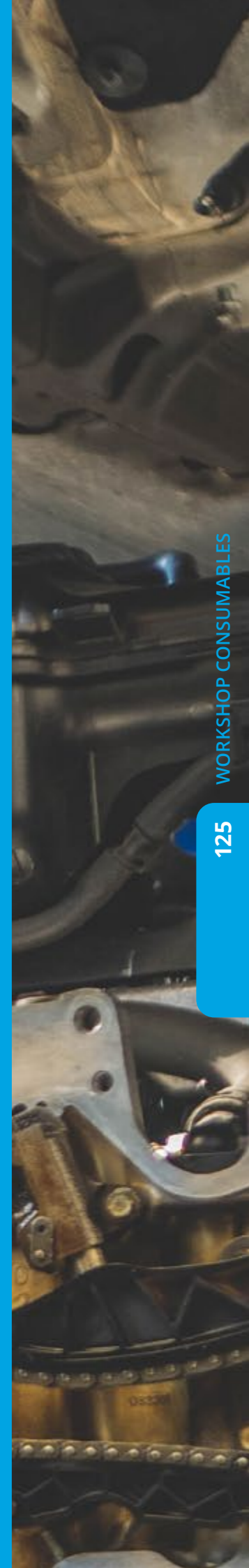





**BIG WIPES  
HEAVY DUTY  
SCRUB & CLEAN WIPES  
TUB OF 80**

Dual sided, textured, scrub and clean Heavy-Duty wipes offer the fastest deepest clean ever - use them for just about every cleaning task. The unique combination of power cleansers targets the toughest grime to ensure our wipes never get stuck in your muck.

- Remove paint, adhesive, Poly foam, gap fill, oil and more from hands, tools & surfaces.
- Dual sided abrasive fabric for the toughest jobs - Abrasive side removes even the most stubborn grime, while the smooth side soaks up the grime.
- Upgraded 4x4 formula - contains 4 powerful cleaning agents + 4 skin conditioners: Aloe Vera, Lanolin, Vitamin E and Glycerine.
- Dermatologically tested to be safe on hands.
- Contains 80 wipes (8inx 12in)



PRODUCT CODE  
**66 2420**

**BIG WIPES MERCHANDISERS**

- Big Wipes Try Me! counter display
- Big Wipes counter display
- Big Wipes floor display stand



**J-B WELD  
WINDSHIELD SAVER REPAIR KIT**

Minimizes the appearance of damages on the windshield. Repairs damages up to 1.25in in diameter and prevents further spreading.

- Can be used on all laminated windshields.
- Minimises the appearance of chips and stars.
- Repairs up to 1/4 inch diameter damage.
- Prevents further spreading.

PRODUCT CODE  
**69 2100**



**J-B WELD  
TANK WELD REPAIR KIT**

Contains everything required for making professional quality permanent repairs of metal and fuel storage containers from leaks caused by cracks or holes.

- Fuel & metal tank repair kit.
- Can be used on cracks of 4in or less and holes up to 1/4in in diameter.
- No welding required.
- Kit contains epoxy putty, fibre glass cloth, sandpaper and applicator.

PRODUCT CODE  
**69 2110**



**J-B WELD  
RADIATOR WELD REPAIR KIT**

For permanent or temporary repairs on metal and plastic radiators and plastic liquid storage containers from leaks caused by cracks or holes.

- Can be used on cracks of 4in or less and holes up to 1/4in in diameter.
- Kit contains epoxy putty, fibre glass cloth, sandpaper and applicator brush.
- Stops leaks.
- No removal required.

PRODUCT CODE  
**69 2120**



**J-B WELD  
LEATHER WELD REPAIR KIT**

Easy to use DIY repair product that does not require conventional heating irons or heating tools to fix torn or cracked vinyl or leather.

- Great for car interiors, boats, office furniture, leather clothes and leather accessories
- Use on automotive, cloth/ carpet and more

PRODUCT CODE  
**69 2130**



**J-B WELD  
PERMA-LOCK BLUE  
THREADLOCKER**

Reliable and superior lock and seal for threaded fasteners. Ideal for use on all mechanical parts, body assemblies, and hundreds of other applications to prevent loosening of fasteners from shock and vibration.

- Medium strength Ideal for fastener applications requiring easy disassembly with hand tools.
- Provides a reliable, superior lock and seal.
- Temperature resistant to 149C.

PRODUCT CODE  
**69 24206 6ML**  
**69 24213 13ML**  
**69 24236 36ML**



**J-B WELD  
PERMA-LOCK RED  
THREADLOCKER**

Reliable and superior lock and seal for threaded fasteners. Ideal for use on all mechanical parts, body assemblies, and hundreds of other applications to prevent loosening of fasteners from shock and vibration.

- Medium strength Ideal for fastener applications requiring easy disassembly with hand tools.
- Provides a reliable, superior lock and seal.
- Temperature resistant to 149C.

PRODUCT CODE  
**69 27106 6ML**  
**69 27113 13ML**  
**69 27136 36ML**



**J-B WELD  
SUPERWELD SUPER GLUE**

SuperWeld is a specially formulated cyanoacrylate super glue that provides a strong, instant bond in just seconds. It works on multiple and hard to bond surfaces. The brush applicator allows for even and pin point surface application.

- A specially formulated cyanoacrylate super glue.
- Provides a strong, instant bond in just seconds.
- It works on multiple and hard to bond surfaces.

PRODUCT CODE  
**69 33102 2G X 2 TUBES WITH NOZZLES**  
**69 33106G 6G BRUSH APPLICATOR**  
**69 33120 20G**  
**69 33220 20G (WITHOUT BLISTER PACKAGING)**  
**69 33400 15G**



**J-B WELD CLEAR ALL PURPOSE RTV SILICONE SEALANT & ADHESIVE 85G TUBE**

All purpose sealant and adhesive, suitable for automotive and household applications. The silicone forms a tough, waterproof, mildew and mould resistant seal on most surfaces.

- Room temperature vulcanisation, all purpose technology.
- Set time: 1 hour.
- Fully cures in 24 hours.
- Forms a tough, waterproof seal on most surfaces.

PRODUCT CODE  
**69 31310**



**J-B WELD WHITE ALL PURPOSE RTV SILICONE SEALANT & ADHESIVE 85G TUBE**

Waterproof general purpose sealant adhesive that is ideal in applications such as bathtubs, showers, sinks, bathroom fixtures, windows, interior trim, door frames, moulding and lens housings.

- Designed for use in household or mechanical jobs.
- Forms a tough, waterproof seal on most surfaces.
- White, set time: 1 hour.
- Mold and mildew resistant.

PRODUCT CODE  
**69 31312**



**JB WELD RED HIGH TEMP RTV SILICONE 85G TUBE**

RTV (Room Temperature Vulcanized) silicone gasketing material, designed for use in mechanical assemblies where the existence of higher, continuous temperatures up to 343C intermittent might exist.

- Room temperature vulcanisation, all purpose technology.
- Red, set time: 1 hour.
- Will not shrink or crack and resists weathering.

PRODUCT CODE  
**69 31314**



**JB WELD BLUE RTV SILICONE GASKET MAKER AND SEALANT 85G TUBE**

An RTV (Room Temperature Vulcanized) silicone gasketing material designed for use in mechanical assemblies, sealing and bonding uneven surfaces.

- Blue RTV silicone gasket maker and sealant.
- Will not shrink or crack and resists weathering.
- Blue, set time: 1 hour.
- Forms a tough, waterproof seal on most surfaces.

PRODUCT CODE  
**69 31316**



**J-B WELD BLACK RTV SILICONE GASKET MAKER AND SEALANT 85G TUBE**

A general purpose RTV (Room Temperature Vulcanized) silicone, designed for sealing and bonding uneven surfaces. Upon curing, the silicone forms a tough, waterproof seal on most surfaces.

- For use in household or mechanical jobs.
- Black, set time: 1 hour.
- Forms a tough, waterproof seal on most surfaces.
- Will not shrink or crack and resists weathering.

PRODUCT CODE  
**69 31319**



**J-B WELD ULTIMATE COPPER RTV SILICONE GASKET MAKER & SEALANT 85G TUBE**

RTV (Room Temperature Vulcanized) silicone gasketing material that is three times more oil resistant than conventional silicones and designed to resist the high operating temperatures of turbocharged or high-performance engines.

- Advanced high temperature RTV sealant adhesive.
- Designed for high operating temperatures.

PRODUCT CODE  
**69 32325**



**J-B WELD ULTIMATE GREY RTV SILICONE GASKET MAKER & SEALANT 85G TUBE**

For use in mechanical assemblies where higher torque or closely spaced bolt profiles can lead to higher loads and cause gasket and sealing failures for average silicones.

- Designed for use in mechanical assemblies.
- Use in higher torque and higher load applications.
- Resistance up to 260°C.
- Set time: 1 hour.

PRODUCT CODE  
**69 32327**



**J-B WELD ULTIMATE BLACK RTV SILICONE GASKET MAKER & SEALANT 85G TUBE**

For use in mechanical assemblies where maximum petroleum and oil resistance is required. Upon curing, the silicone forms a tough, waterproof, gasket and seal on most surfaces.

- Ultimate black RTV gasket maker and sealant.
- Designed for use in mechanical assemblies.
- Maximum petrol and oil resistance.
- Resistance up to 260°C.
- Set time: 1 hour.

PRODUCT CODE  
**69 32329**



**J-B WELD ULTIMATE BLACK RTV SILICONE GASKET MAKER & SEALANT 14G TUBE**

For use in mechanical assemblies where maximum petroleum and oil resistance is required.

- Ultimate black RTV gasket maker and sealant.
- Designed for use in mechanical assemblies.
- Maximum petrol and oil resistance.
- Temperature resistance up to 260C.
- Set time: 1 hour, Cure colour: Black.

PRODUCT CODE  
**69 32509**



**J-B WELD WATER PUMP & THERMOSTAT HOUSING RTV SILICONE 14G TUBE**

Specially designed RTV (Room Temperature Vulcanized) silicone gasketing material for use in mechanical assemblies.

- Water pump and thermostat gasket maker/sealant.
- Maximum oil resistance.
- Forms a tough, waterproof seal on most surfaces.
- Temperature resistance up to 260C.
- Set time: 1 hour, Cure colour: Black.

PRODUCT CODE  
**69 32507**



**J-B WELD RED HIGH TEMP RTV SILICONE 292G CARTRIDGE**

RTV (Room Temperature Vulcanized) silicone gasketing material, designed for use in mechanical assemblies where the existence of higher, continuous temperatures up to 343 degrees Celsius intermittent might exist.

- Set time: 1 hour, Cure colour: Red.
- Will not shrink or crack and resists weathering.
- Red hi-temp RTV silicone gasket maker and sealant.

PRODUCT CODE  
**69 31914**



**J-B WELD BLACK RTV SILICONE SEALANT & ADHESIVE 85G TUBE**

RTV (Room Temperature Vulcanized) silicone, designed for sealing and bonding uneven surfaces. Upon curing, the silicone forms a tough, waterproof seal on most surfaces.

- Designed for use in household or mechanical jobs.
- Set time: 1 hour, Cure colour: Black.
- Will not shrink or crack and resists weathering.

PRODUCT CODE  
**69 31919**



**J-B WELD ULTIMATE GREY RTV SILICONE GASKET MAKER & SEALANT 269G CART**

Designed for use in mechanical assemblies where higher torque or closely spaced bolt profiles can lead to higher loads and cause gasket and sealing failures for average silicones.

- Use in higher torque and higher load applications.
- Temperature resistance up to 260C.
- Set time: 1 hour, Cure colour: Grey.

PRODUCT CODE  
**69 32927**



**J-B WELD ULTIMATE BLACK RTV SILICONE GASKET MAKER & SEALANT 269G CART**

Designed for use in mechanical assemblies where maximum petroleum and oil resistance is required. Upon curing, the silicone forms a tough, waterproof, gasket and seal on most surfaces.

- Designed for use in mechanical assemblies.
- Maximum petrol and oil resistance.
- Temperature resistance up to 260C.
- Set time: 1 hour, Cure colour: Black.

PRODUCT CODE  
**69 32929**



**J-B WELD MIRRORWELD**

Why spend time and money on mirror adhesives that aren't going to last? Instead, use J-B Weld Mirror Weld, the most effective adhesive on the market, to reattach your rear view mirror. When exposed to UV light, shock, or vibration.

- Specially formulated rear view mirror adhesive.
- Includes adhesive and accelerator.
- Sets in 1 minute.
- Cures in 1 hour.
- Used to install new mirrors, and re-attached mirrors that have fallen.

PRODUCT CODE  
**69 33701**



**J-B WELD VALVE GRINDER 42G**

J-B Weld Valve Grinder is a water-based odourless and abrasive paste designed to aid in valve grinding and lapping operations on engines to remove burrs, surface defects, deposits and corrosion.

- Water-based odourless abrasive paste.
- Grinding & lapping compound for valve faces and seats.
- Removes burrs, defects & corrosion.
- Auto-adjust grit: application starts as a coarse 120 grit, then grinds down to 150, 180, and then a fine 220.

PRODUCT CODE  
**69 37801**



**J-B WELD EXTREME HEAT METALLIC PASTE 85.2G**

Organic repair paste able to withstand extreme heat up to 1300C. Organic repair paste can be used for filling cracks and holes on metal surfaces. Sets in 1 hour and dries machine grey to a functional cure in 24 hours.

- Temperature resistant metallic paste.
- Cure colour: Machine grey.
- Cure time: 24 hours, Set time: 1 hour.
- Able to withstand continuous heat to 1300°C.
- Used for filling cracks and holes on metal surfaces.

PRODUCT CODE  
**69 37901**



**J-B WELD METAL STRAPPING KIT**

J-B Weld Metal Strapping Kit is a 5 foot galvanized metal strip that accommodates a 1/4in bolt and nut to do temporary or permanent repairs on mufflers, exhaust, general automotive or household items.

- Great for: muffler clamps, tail pipe hanger, pipe hanger and work benches.
- Can also be used for household, gutter and downspout support.

PRODUCT CODE  
**69 37990**



**J-B WELD AUTOMOTIVE REPAIR CAST**

Permanent Repair Cast is a high-strength one-time use fiberglass wrap, impregnated with a specially formulated resin designed to adhere to a wide variety of surfaces. When activated by water, the product forms a strong, permanent bond that hardens like steel in 15 minutes.

- Once the product is dipped in water for 5-7 seconds, you will have between 5-10 minutes to work with the product and then it will fully cure in 15 minutes!
- J-B Weld FiberWeld Repair Cast has a bend strength of 1500 PSI. Once the product is fully cured, it can be sanded and painted!
- Great for outdoor/indoor furniture, tool handles, yard equipment, pipes & hoses, sporting & camping gear, preventative reinforcement and more!

PRODUCT CODE  
**69 38237**



**J-B WELD TAILPIPE & PIPE REPAIR WRAP**

J-B Weld Tailpipe and Pipe Repair Wrap is a high-strength, fiberglass cloth, infused with temperature-resistant adhesive for a lasting repair. When cured, it hardens like steel and is able to withstand temperatures up to 800 degrees F.

- 2in x 70in temperature resistant fiberglass tape.
- Withstands up to 800°F
- 1 hour cure time
- Hardens like steel
- Repairs, seals & insulates tailpipes and mufflers

PRODUCT CODE  
**69 38503**



**J-B WELD EXHAUST SYSTEM CRACK JOINT & SEAM SEALANT 85G TUBE**

J-B Weld Exhaust system sealant is a heat resistant paste that is used to seal gaps, smooth seams or seal pipe connections within an exhaust system reassembly or repair. The paste is resistant to temperature of up to 1800F with negligible, if any shrinkage.

- Set time: 30 minutes.
- Temperature resistant up to 1800F.
- Non-shrinking.
- Great for: Mufflers, tailpipes, catalytic converters and exhaust pipe connections.

PRODUCT CODE  
**69 37903**



**J-B WELD MUFFLER SEAL CEMENT PASTE 170G TUBE**

MufflerSeal Muffler Cement is a metal containing paste that prevents and seals leaks at seams and gaps of pipe and exhaust connection points. When fully cured, this paste dries to a cement-like hardness that is heat resistant up to 700° F.

- SET TIME: 2- 4 hours
- CURE TIME: 24 hours
- CURE COLOUR: Dark Grey.
- GREAT FOR: Mufflers, pipe joints, exhaust systems, seams cracks, gaps & joints.
- 6 oz.

PRODUCT CODE  
**69 37906**



**J-B WELD MUFFLER SEAL CEMENT PASTE 340G TUBE**

MufflerSeal Muffler Cement is a metal containing paste that prevents and seals leaks at seams and gaps of pipe and exhaust connection points. When fully cured, this paste dries to a cement-like hardness that is heat resistant up to 700° F.

- SET TIME: 2- 4 hours
- CURE TIME: 24 hours
- CURE COLOUR: Dark Grey.
- GREAT FOR: Mufflers, pipe joints, exhaust systems, seams cracks, gaps & joints.
- 12 oz.

PRODUCT CODE  
**69 37912**



**J-B WELD ULTRA HEAT WRAP CERAMIC EXHAUST SYSTEM REPAIR KIT**

J-B Weld Ultra Heat Wrap is high-strength temperature resistant, ceramic cloth material, infused with a high temperature adhesive. When fully cured it hardens like steel and able to withstand temperatures up to 1800 degrees F.

- 2in x 35in temperature resistant ceramic fiber tape
- Withstands over 1500°F
- 30 minute cure time
- Flame resistant
- Exhaust system repair

PRODUCT CODE  
**69 38553**



**J-B WELD RIGID PATCH**

The Rigid Patch is the perfect solution for repairs that you can't wrap. Simply place the patch on the broken area, expose to natural or UV light and in less than 15 minutes it will cure!

- Wet, apply and let it dry!
- Works on composites, metals, wood, plastics and more.
- Great for repairs on boats, pools, spas, tubs/showers, yard equipment, auto body, gutters and more.

PRODUCT CODE  
**69 39036**



J-B Weld offers a complete, innovative range of strongest in class products to help DIYers of all skill levels confidently pull off projects both big and small, from the workshop to the garage to the home. Our mission is to help you tap into the confidence and self-reliance you already have to help you "Be Your Strongest Self".



**J-B WELD  
WOOD RESTORE  
LIQUID HARDENER 474ML**

J-B wood restore liquid hardener is a quick drying liquid for sealing and reinforcing decayed or rotted wood; for reducing moisture in decaying or rotted wood surfaces, prior to putty filling. The special liquid formula penetrates the wood to reinforce the fibres stopping further decay.

- Seals rotted wood surfaces.
- Easy brush on application.
- No mix formula.
- Reduces moisture in rotted wood.
- Forms solid base for filling.

PRODUCT CODE  
**69 40001**



**J-B WELD  
WOOD RESTORE  
REPAIR PUTTY WOOD FILLER 354ML**

J-B wood restore repair putty wood filler provides a permanent repair to damaged and rotted wood. J-B wood filler's professional strength formula is ideal for interior and exterior wood projects. Use to fill in small cracks or large holes.

- Provides permanent repairs to damaged wood.
- Ideal for interior or exterior wood projects.
- Use to fill small cracks or large holes.
- Provides a hard workable surface in 15 minutes.
- Can be tapped, filed, sanded, drilled and painted.

PRODUCT CODE  
**69 40003 354ML**  
**69 40004 946ML**



**J-B WELD  
WOOD RESTORE  
PREMIUM LIQUID EPOXY 946ML**

J-B Weld Wood Restore Premium Liquid Epoxy is a high strength liquid epoxy coating. It is a specially formulated coating that can be used to seal wood surfaces with a durable clear finish, or to strengthen wood surfaces damaged over time.

- High-strength liquid epoxy resin for coating
- Seals and strengthens damaged or rotted wood
- Penetrates into wood to reinforce the fibres
- Crystal clear finish
- Set time: 30 mins
- Cure time: 12 hours

PRODUCT CODE  
**69 40002**



**J-B WELD  
WOOD RESTORE  
PREMIUM EPOXY PUTTY WOOD  
REPAIR COMPOUND 946ML**

J-B weld wood restore premium epoxy putty repair compound is a hand mixable epoxy putty specially formulated to repair and rebuild wood quickly and easily. When applied it adds structural strength to areas of damaged or rotted wood.

- Hand-mixable wood repair epoxy putty.
- Adds structural strength to damaged areas of wood.
- Cures to the same density of wood.
- For interior or exterior use.
- Can be tapped, filed, sanded, drilled and painted.

PRODUCT CODE  
**69 40006**



**J-B WELD  
MUFFLER PATCH KIT**

Temperature resistant epoxy combined with fiberglass that cures with heat. When in contact with a heat source, this product will cure itself and form a strong, permanent patch to the underlying surface.

- Cures with heat in 20 minutes.
- Hardens strong as steel.
- Can withstand temperatures up to 600F.

PRODUCT CODE  
**69 39205**



**J-B WELD  
TIGER PATCH KIT**

Temperature resistant epoxy combined with fiberglass that cures with heat. When in contact with a heat source, this product will cure itself and form a strong, permanent patch to the underlying surface.

- Withstands up to 600F.
- Hardens like steel with heat in 20 minutes.
- Comes with aluminum tape for long-term patch repair on mufflers & tailpipes.
- Great for mufflers, exhaust systems, seams, cracks, gaps, joints, automotive and machine parts.

PRODUCT CODE  
**69 39206**



**J-B WELD  
FIBERWELD PERMANENT  
FIBREGLASS REPAIR CAST**

Permanent Repair Cast is a high-strength one-time use fiberglass wrap, impregnated with a specially formulated resin designed to adhere to a wide variety of surfaces. When activated by water, the product forms a strong, permanent bond that hardens like steel in 15 minutes.

- Cure and Set Time: Once the product is dipped in water for 5-7 seconds, you will have between 5-10 minutes to work with the product and then it will fully cure in 15 minutes!
- J-B Weld FiberWeld Repair Cast has a bend strength of 1500 PSI. The kit includes a pair of gloves and a securing bandage!
- Great For: Outdoor/Indoor furniture, Tool Handles, Yard Equipment, Pipes & Hoses, Sporting & Camping Gear, Preventative Reinforcement and more!
- Big or small, you can DIY it with J-B Weld. Our heavy duty epoxy and adhesives repair & restore it right the first time.
- Surface Applications: Metal, Most Plastics, Wood, PVC, Fiberglass, Rubber and more!
- Set Time: 5-10 minutes.
- Cure Time: 15-20 minutes.
- Once the product is fully cured, it can be sanded and painted!

PRODUCT CODE  
**69 38236**



**J-B WELD  
FIBERWELD  
FIBERGLASS PIPE  
REPAIR CAST**

J-B Weld FiberWeld is a high-strength one-time use fiberglass wrap, impregnated with a specially formulated anti-corrosive resin providing a permanent and protective adhesion to a wide variety of pipes.

- Cure and Set Time: Once the product is dipped in water for 5-7 seconds, you will have between 5-10 minutes to work with the product and then it will fully cure in 15 minutes!
- Bend strength of 1800 PSI. The kit includes a pair of gloves, an epoxy putty stick and a securing bandage!
- Great For Repairs On: Copper, Cast Iron, PVC, ABS, Galvanized Steel, Rubber and more!
- Big or small, you can DIY it with J-B Weld. Our heavy duty epoxy and adhesives repair & restore it right the first time.
- Surface Applications: Copper, Cast Iron, PVC, ABS, Galvanized Steel, Rubber and more!
- Set Time: 5-10 minutes.
- Cure Time: 15-20 minutes.
- Once the product is fully cured, it can be sanded and painted!

PRODUCT CODE  
**69 38248 1 INCH**  
**69 38260 2 INCH**



**J-B WELD  
EXHAUST WELD**

ExhaustWeld Total Exhaust Repair Wrap is a high strength fiberglass wrap, impregnated with a specially formulated resin for high temperature resistant repairs.

- A high strength fiberglass wrap, impregnated with a specially formulated resin for high temperature resistant repairs. ExhaustWeld can resist up to 1100°F once it is fully cured!
- ExhaustWeld can cure with or without heat! It will cure within 20 minutes if heat is applied to it with either a heat gun or by letting the engine run.
- Once fully cured, J-B Weld ExhaustWeld Exhaust System Repair Wrap has a temperature resistance of 1100°F, allowing it to be used on every part of the exhaust system!
- Great for manifolds, catalytic converters, mufflers, tailpipes and more!
- The kit includes a pair of gloves and a 0.5in x 24in piece of aluminum tape!

PRODUCT CODE  
**69 38572**



**J-B WELD  
STATIC MIXERS 2 PACK**

J-B Weld Static Mixers are easy-to-use attachments for any of J-B Weld 25 ml syringes that allow for precise mixing of our two-component adhesives. Each mixer comes with 16 static elements to ensure complete mixing.

- 16 elements to ensure proper mixing every time.
- Works on all JB weld syringes.
- Precision tip for dispensing control.
- 2 pack.

PRODUCT CODE  
**69 50099**



**J-B WELD  
MINUTEWELD  
CLEAR INSTANT SETTING EPOXY  
SYRINGE 25ML**

MinuteWeld is a special formulated, high-strength, two-part instant setting epoxy. MinuteWeld will set under most temperature conditions in one minute. MinuteWeld is designed to adhere to multiple surfaces and can be used on ceramic, tile, glass, stone, most plastics, wood and metal.

- High-strength, two-part instant setting epoxy.
- Will set in one minute under most temperatures.
- Designed to adhere to multiple surfaces.
- Strength 2850 psi, Set time: 1 min.
- Cure time: 1 hour, Cure colour: Clear.

PRODUCT CODE  
**69 50101**



**J-B WELD  
CLEARWELD  
CLEAR QUICK SETTING EPOXY  
SYRINGE 25ML**

ClearWeld is a quick setting, multi-purpose two part epoxy that provides a strong and lasting bond on most surfaces including tile, most plastics, ceramic, glass, wood and metal. ClearWeld is designed to cure with a clear, transparent bond when used at thicknesses of less than 15mm.

- Quick setting two-part, multi-purpose epoxy.
- Creates a strong, long lasting bond.
- Bonds tile, ceramic, glass, wood and plastics.
- Strength 4400 psi, Set time: 5 mins.
- Cure time: 1 hour, Cure colour: Clear.

PRODUCT CODE  
**69 50112**



**J-B WELD  
CLEARWELD SYRINGE 14ML**

ClearWeld is a quick setting, multi-purpose two part epoxy that provides a strong and lasting bond on most surfaces including tile, most plastics, ceramic, glass, wood and metal. ClearWeld is designed to cure with a clear, transparent bond when used at thicknesses of less than 15ml.

- Great for: Tiles, most plastics, ceramic, glass, wood and metal.
- Use on: Automotive, brick, ceramic, cloth/carpets, concrete, fiberglass, glass, plastic/composite/PVC and more.
- Strength: 3900 PSI.
- Set time: 5 minutes.
- Cure time: 1 hour.
- Cure colour: clear.

PRODUCT CODE  
**69 50114**



**J-B WELD  
PLASTICWELD  
QUICK SETTING EPOXY SYRINGE 25ML**

PlasticWeld is a specially formulated two-part adhesive and epoxy filler system that provides for strong, lasting repairs. PlasticWeld will bond a variety of surfaces, such as metal, composites, fiberglass and others.

- Will bond a variety of surfaces.
- Long lasting bond.
- Strength 4400 psi, Set time: 5 mins.
- Cure time: 1 hour, Cure colour: Off white.

PRODUCT CODE  
**69 50132**



**J-B WELD  
PLASTICBONDER TAN ADHESIVE,  
FILLER & SEALER SYRINGE 25ML**

Plastic Bonder is a quick-setting, two-part, urethane adhesive system that provides strong and lasting repairs and works on thermoset, carbon fibre composites, thermoplastics, coated metals, concrete and more.

- Two-part, urethane adhesive system.
- Creates strong, long lasting repairs.
- Works on thermoset, thermoplastics and more.
- Strength 3770 psi, Set time: 15 mins.
- Cure time: 30 mins, Cure colour: Tan.

PRODUCT CODE  
**69 50133**



**J-B WELD  
PLASTICBONDER  
BLACK ADHESIVE & GAP FILLER  
SYRINGE 25ML**

Plastic Bonder is a quick-setting, two-part, urethane adhesive system that provides strong and lasting repairs and works on thermoset, carbon fibre composites, thermoplastics, coated metals, concrete and more.

- Two-part, urethane adhesive system.
- Creates strong, long lasting repairs.
- Works on thermoset, thermoplastics and more.
- Strength 3770 psi, Set time: 15 mins.
- Cure time: 30 mins, Cure colour: Black.

PRODUCT CODE  
**69 50139**



**J-B WELD  
WOODWELD  
LIGHT TAN QUICK SETTING EPOXY  
SYRINGE 25ML**

WoodWeld is a fast setting two-part epoxy system formulated for wood bonding and repairs. When fully cured it can be shaped, tapped, filed, sanded and drilled. It provides a lasting permanent bond that is stronger than wood!

- GREAT FOR: Indoor/outdoor, furniture, doors, windows, trim/moulding, decks & more
- USE ON: Rotted wood, non-rotted wood & more

PRODUCT CODE  
**69 50151**



**J-B WELD  
COLDWELD  
DARK GREY STEEL REINFORCED EPOXY  
SYRINGE 25ML**

J-B Weld two-part epoxy cold weld system provides strong, lasting repairs to metal and multiple other surface types. After mixing, it forms a permanent bond and can be shaped, tapped, filed, sanded and drilled after curing.

- Two-part, cold weld epoxy system.
- Creates strong, long lasting repairs.
- Can be shaped, tapped, filed, sanded and drilled.
- Strength 3960 psi, Set time: 4-6 hours.
- Cure time: 15-24 hours, Cure colour: Dark grey.

PRODUCT CODE  
**69 50165**



**J-B WELD  
MARINEWELD  
WHITE MARINE ADHESIVE  
SYRINGE 25ML**

MarineWeld is a specially formulated two part Cold-Weld adhesive system that provides strong, lasting repairs for bonding different or similar surfaces, such as metal, composites, fiberglass and others.

- Retains full strength above or below water surface.
- Can be shaped, tapped, filed, sanded and drilled.
- Strength 3200 psi, Set time: 20 mins.
- Cure time: 15 - 24 hours, Cure colour: White.

PRODUCT CODE  
**69 50172**



**J-B WELD  
KWIKWELD  
DARK GREY STEEL REINFORCED  
EPOXY SYRINGE 25ML**

KwikWeld is a fast setting two-part epoxy cold weld system that provides strong, lasting repairs to metal and multiple other surface types. After mixing, it forms a permanent bond and can be shaped, tapped, filed, sanded and drilled after curing.

- Can be shaped, tapped, filed, sanded and drilled.
- Strength 2424 psi, Set time: 6 mins.
- Cure time: 4 - 6 hours, Cure colour: Dark grey.

PRODUCT CODE  
**69 50176**



**J-B WELD  
CLEARWELD  
PROFESSIONAL  
SIZE 8 OZ**

ClearWeld Professional Size is professional size of our quick setting, multi-purpose two part epoxy that provides a strong and lasting bond on most surfaces including tile, most plastics, ceramic, glass, wood and metal.

- Great for: Tiles, most plastics, ceramic, glass, wood and metal.
- Use on: Automotive, brick, ceramic, cloth/carpets, concrete, fiberglass, glass, plastic/composite/PVC and more.
- Cure colour: clear.
- Set time: 5 minutes.
- Cure time: 1 hour.

PRODUCT CODE  
**69 50240H**



**J-B WELD CLEARWELD TWIN TUBE 16ML**

ClearWeld is a quick setting, multi-purpose two part epoxy that provides a strong and lasting bond on most surfaces including tile, most plastics, ceramic, glass, wood and metal. ClearWeld is designed to cure with a clear, transparent bond.

- Great for: Tile, most plastics, ceramic, glass, wood & metal.
- Use on: Automotive, brick, ceramic, cloth/ carpet, concrete, fiberglass, glass, plastic/ composite/PVC and more.
- Strength: 3900 PSI.
- Set time: 5 minutes.
- Cure time: 1 hour.
- Cure colour: Clear.

PRODUCT CODE  
**69 8212**



**J-B WELD TANKWELD PETROLEUM RESISTANT EPOXY PUTTY STICK 28.4G**

AutoWeld is a hand-mixable, steel-reinforced, non-rusting epoxy putty that quickly repairs or rebuilds anything made of metal. After mixing, it forms an industrial-strength polymer compound that can be moulded into shapes or used to build up, patch and repair steel components.

- Steel reinforced epoxy putty stick.
- Set time: 5 mins, Cure colour: Dark Grey.
- Strength 900 PSI.

PRODUCT CODE  
**69 8217**



**J-B WELD PLASTICWELD PLASTIC REPAIR EPOXY PUTTY STICK 28.4G**

PlasticWeld is a hand-mixable, fast-setting epoxy putty that forms a durable bond to most major plastic types. After mixing, it forms a polymer compound that can be moulded or used to build up and repair just about anything made from plastic.

- Forms a durable bond to most plastic types.
- Can be moulded to repair most plastic applications.
- Can be sawed, drilled, carved and sanded.
- Strength 350 psi, Set time: 25 mins.
- Cure time: 3 hours, Cure colour: Off white.

PRODUCT CODE  
**69 8237**



**J-B WELD KWIKWELD PROFESSIONAL SIZE 10 OZ**

J-B Weld is The Original Cold Weld two-part epoxy system that provides strong, lasting repairs to metal and multiple surfaces. Mixed at a ratio of 1:1, it forms a permanent bond and can be shaped, tapped, filed, sanded and drilled after curing.

- Great for household repairs, automotive, plumbing, marine, crafts and more.
- Use on automotive, brick, concrete, metal and more.
- Strength: 5020 PSI.
- Set time: 4-6 hours.
- Cure time: 15-24 hours.
- Cure colour: Dark grey.

PRODUCT CODE  
**69 8271**



**J-B WELD MARINEWELD MARINE EPOXY TWIN 28.4G TUBES**

MarineWeld is a specially formulated two-part epoxy cold weld system. Provides for strong, lasting repairs for bonding different or similar surfaces, such as aluminium, metal, composites, fiberglass and others.

- Can be shaped, tapped, filed, sanded and drilled.
- Waterproof when fully cured.
- Strength: 3960 psi, Set time: 20-25 mins.
- Cure time: 15-24 hours, Cure colour: Dark grey.

PRODUCT CODE  
**69 8272**



**J-B WELD KWIKWELD STEEL REINFORCED EPOXY TWIN 28.4G TUBES**

KwikWeld is a fast setting version of the original J-B Weld two-part epoxy cold weld system that provides strong, lasting repairs to metal and multiple other surface types. Forms a permanent bond and can be shaped, tapped, filed, sanded and drilled after curing.

- Can be shaped, tapped, filed, sanded and drilled.
- Strength: 2424 psi, Set time: 6 mins.
- Cure time: 4-6 hours, Cure colour: Dark grey.

PRODUCT CODE  
**69 8276**



**J-B WELD KWIKWOOD WOOD REPAIR EPOXY PUTTY STICK**

KwikWood is a hand-mixable epoxy putty, formulated to repair and rebuild wood. After mixing, it cures to the same density as wood and becomes an integral part of the repair. Contains no solvents, will not rot, shrink, crack or pull away.

- USE ON: Rotted wood, wood and more Formulated to repair and rebuild wood.
- For use on interior or exterior applications.
- Can be tapped, filed, machined and drilled.
- Strength 900 psi, Set time: 25 mins.
- Cure time: 1 hour, Cure colour: Light tan.

PRODUCT CODE  
**69 8257 28G**  
**69 8258 57G**



**J-B WELD COLDWELD STEEL REINFORCED EPOXY TWIN 28.4G TUBES**

This cold weld two-part epoxy system that provides strong, lasting repairs to metal and multiple surfaces. Mixed at a ratio of 1:1, it forms a permanent bond and can be shaped, tapped, filed, sanded and drilled after curing.

- Can be shaped, tapped, filed, sanded and drilled.
- Cure time: 15-24 hours, Cure colour: Dark grey.
- Strength: 3960 psi, Set time: 4-6 hours.
- Great for household repairs, automotive projects, plumbing and marine applications, crafts etc.

PRODUCT CODE  
**69 8265S**



**J-B WELD STEELSTIK STEEL REINFORCE EPOXY PUTTY STICK 57G**

SteelStik is a hand-mixable, steel-reinforced, non-rusting epoxy putty that quickly repairs or rebuilds anything made of metal. After mixing, it forms an industrial-strength polymer compound that can be moulded into shapes or used to build up, patch and repair steel components.

- Repairs or rebuilds anything made of metal.
- Can be tapped, filed, machined and drilled.
- Strength 900 psi, Set time: 5 mins.
- Cure time: 1 hour, Cure colour: Dark grey.

PRODUCT CODE  
**69 8267S**



**J-B WELD WATERWELD EPOXY PUTTY STICK 57G**

WaterWeld will plug or seal leaks and patch holes and cracks in almost anything. Ideal for repairing plumbing, fuel tanks, tub and shower, drains, pool and spa, boats and potable water tanks; setup occurs even under water.

- Will plug or seal leaks and patch holes.
- Will even set under water.
- Can be tapped, filed, machined and drilled.
- Strength 900 psi, Set time: 25 mins
- Cure time: 1 hour, Cure colour: Off white.

PRODUCT CODE  
**69 8277**



**J-B WELD COLDWELD STEEL REINFORCED EPOXY TWIN 141.8G TUBES**

J-B Weld is the original cold weld two-part epoxy system that provides strong, lasting repairs to metal and multiple surfaces. Forms a permanent bond and can be shaped, tapped, filed, sanded and drilled after curing.

- Great for: household repairs, automotive, plumbing, marine, crafts and more
- Use on: automotive, brick, concrete, metal and more.

PRODUCT CODE  
**69 8281**



**J-B WELD HIGH HEAT TEMPERATURE RESISTANT EPOXY PUTTY STICK 57G**

High heat is a hand mixable epoxy putty stick specifically formulated to bond and repair materials that will be exposed to high temperatures in automotive and industrial maintenance applications. It cures to a tough, hard bond with little to no shrinkage.

- Hand-mixable temperature resistant epoxy putty.
- Formulated for high temperature applications.
- Can be tapped, filed, machined and drilled.
- Strength 800 psi, Set time: 1 hour.
- Cure time: 8 hour, Cure colour: Machine grey.

PRODUCT CODE  
**69 8297**



**QUIKSTEEL EPOXY PUTTY 56.8G**

This QuikSteel Epoxy putty withstands up to 500 degrees Fahrenheit temperatures, sets in 5 minutes, is steel hard in 15 minutes and cures in one hour. Cures under water and can be drilled, tapped, filed, sanded and painted.

- Steel reinforced epoxy putty.
- Sets in 5 minutes, is steel hard in 15 minutes and fully cured in 1 hour.
- Withstands temperatures up to 260°C.
- Thousands of uses.
- Can be drilled, tapped, filed, sanded and painted.

PRODUCT CODE  
**69 16002**

**QUIKSTEEL PLASTIC REPAIR PUTTY 56.8G**

The white reinforced epoxy putty has a large variety of uses. The product sets in 5 minutes, is steel hard in 15 minutes and fully cured in 1 hour.

- Withstands temperatures up to 260°C.
- Can be drilled, tapped, filed, sanded and painted.

PRODUCT CODE  
**69 16502**

**QUIKSTEEL PLASTIC TANK REPAIR KIT**

QuikSteel plastic repair tank repair kit gives you everything you need to repair plastic fuel tanks, radiators, water tanks, RV holding tanks. No need to remove tank or drain, can make permanent repair in minutes.

- No need to empty tank or remove from vehicle.
- Full instructions included.

PRODUCT CODE  
**69 6522K**

**QUIKSTEEL STEEL REINFORCED EPOXY PUTTY 56.8G**

QuikSteel epoxy putty withstands up to 500 degrees Fahrenheit, sets in 5 minutes, is steel hard in 15 minutes and cures in one hour. Cures under water and can be drilled, tapped, filed, sanded and painted.

- Steel reinforced epoxy putty.
- Withstands temperatures up to 260°C.
- Multiple uses.
- Available in a display carton of 12.

PRODUCT CODE  
**69 6002TRI**



**TEE-KAY HEAD CHEK COMBUSTION LEAK DETECTOR TEST UNIT**

The Tee-Kay head check combustion leak detector is designed to check combustion gases in the cooling system. It works by analysing the air within the 'air cushion' above the radiator coolant level.

- Designed to check combustion gases in the cooling system.
- Suitable for petrol, diesel and LPG engines.
- Replacement fluid available. (P/NO 69 TKFLUID500).
- Some leaks will occur only under certain conditions and the Head Check test must be made under the same conditions to detect the leak.
- Detects combustion leaks in seconds.

PRODUCT CODE  
**69 TKTEST**

**TEE-KAY HEAD CHEK TESTER FLUID 500ML**

Head Check Fluid is a sensitive, chemical indicator and care should be taken to avoid contamination.

- Replacement fluid for 69 TKTEST.
- Store Head Check fluid away from direct sunlight, and store at room temperature.
- Head Check fluid is non-toxic and non-corrosive, but is not for human consumption.

PRODUCT CODE  
**69 TKFLUID500**

# K-Seal® ONE STEP

PERMANENT COOLANT LEAK REPAIR

NO DRAINING/NO FLUSHING SEALS HOLES/CRACKS - JUST POUR AND GO

KSEAL.COM/NZ



**K-SEAL ULTIMATE HEAD GASKET REPAIR 472ML**

K-Seal Ultimate is the simple, permanent fix for blown head gaskets, cracked heads and blocks, and porous engine blocks. Our unique formula works with all water-cooled engines, there is no need to drain or flush your cooling system.

- Will fix blown head gaskets, cracked heads and blocks.
- Mixes with all types of antifreeze and coolants.
- Seals leaks up to 0.635mm in size.
- Simple to use. Just shake, pour and drive.
- A permanent repair, guaranteed for the lifetime of the engine.

PRODUCT CODE  
**69 K3501**



**K-SEAL COOLANT LEAK REPAIR 236ML**

This coolant leak repair is a one step permanent coolant leak repair system - single vehicle size. Just shake the bottle, add the fluid to your coolant system, and run your engine as normal.

- Simple to use. Just shake, pour and go
- Mixes with all antifreeze and coolants.
- No need to drain or flush the system.
- It repairs leaks and cracks in the radiator, head gasket, heater core, freeze plugs, water pump casing, cylinder heads and engine blocks.

PRODUCT CODE  
**69 K5501**



**K-SEAL COOLANT HD LEAK REPAIR 472ML**

K-Seal HD permanent coolant repair is the brand that motor stockists recommend with confidence to their customers with buses, coaches and HGVs. K-Seal HD can be used in the workshop, on the road or on site.

- A one step permanent coolant leak repair system - commercial quantity.
- Mixes with all antifreeze and coolants.
- No need to drain or flush the system.
- Simple to use. Just shake, pour and go.

PRODUCT CODE  
**69 K5516**



**GUMOUT STARTING FLUID 110Z**

Engines need the right conditions to perform properly. Gumout Starting Fluid helps engines start in all types of extreme weather, while conditioning fuel and engine parts to prevent friction and corrosion.

- For petrol engines.
- Works best in extreme cold or humid weather.
- Lubricates upper cylinders.
- Inhibits corrosion.

PRODUCT CODE  
**65 5072866**



**GUMOUT HIGH MILEAGE FUEL INJECTOR CLEANER 177ML**

Gumout High Mileage Fuel Injector Cleaner is specially formulated to remove carbon deposits from engines with over 75,000 miles for restored engine performance and fuel economy.

- Cleans port/indirect fuel injectors, intake valves and ports.
- Prevents future carbon buildup on port/indirect fuel injectors, intake valves and ports, combustion chamber.
- Best for restored performance and fuel economy in high mileage vehicles and reduced emissions.

PRODUCT CODE  
**65 510013**



**GUMOUT MULTI SYSTEM TUNE UP 473ML**

Gumout Multi-System Tune-Up is the most advanced treatment for all types of engines, from cars to lawn mowers. It cleans and conditions using premium ingredients, like P.E.A. (polyetheramine), to help maximize performance, fuel economy and engine life.

- Cleans GDI/direct and port/indirect fuel injectors, carburetors, intake valves and ports, piston tops, cylinder heads, combustion chamber and crankcase.
- Conditions gasoline, ethanol blend and diesel fuels to fight ethanol and water corrosion, fuel and oil to fight deterioration/destabilization.
- Prevents future carbon build up.
- Best for maximized performance, fuel economy, reduced emissions and fuel stabilization.

PRODUCT CODE  
**65 510011**



**GUMOUT COMPLETE FUEL SYSTEM CLEANER 177ML**

Gumout Regane Complete Fuel System Cleaner conditions fuel against corrosion to help extend the life of key engine parts, while using P.E.A. (polyetheramine) to effectively remove deposits other products can't, for maximized performance and fuel economy.

- Cleans GDI/direct and port/indirect fuel injectors, intake valves and ports, piston tops, cylinder heads and combustion chambers.
- Conditions fuel to fight ethanol and water corrosion.
- Prevents future carbon buildup.
- Best for maximized performance and fuel economy in one fill up.

PRODUCT CODE  
**65 510014**



**GUMOUT ALL-IN-ONE DIESEL FUEL SYSTEM CLEANER 320Z**

Gum out All-In-One Diesel Complete Fuel System Cleaner is a unique all season, multi-functional, diesel fuel additive. Unlike other diesel additives that just clean injectors, this product cleans the entire diesel fuel system.

- Cleans all components of the diesel fuel system.
- Improves fuel economy and reduces emissions.
- Restores horsepower and boosts cetane.
- Prevents and fixes diesel fuel gelling.

PRODUCT CODE  
**65 510012**



**GUMOUT FUEL SYSTEM TREATMENT 60Z**

Carbon buildup across the fuel system can reduce the efficiency of engine combustion. Gumout Fuel System Treatment removes carbon deposits from engine parts to maximize engine performance and fuel economy.

- Cleans port/indirect fuel injectors, intake valves and ports.
- Conditions upper cylinder to reduce friction and wear.
- Prevents future carbon buildup on intake valves and ports.
- Best for maximized performance and fuel economy, reduced upper cylinder wear.

PRODUCT CODE  
**65 510015**



**GUMOUT ALL-IN-ONE FUEL SYSTEM CLEANER 296ML**

Engine performance is affected by everything from carbon deposits and corrosion to heat and friction. Gumout All-In-One Complete Fuel System Cleaner uses P.E.A. (polyetheramine) to effectively remove carbon deposits.

- Cleans GDI/direct and port/indirect fuel injectors, intake valves and ports, piston tops, cylinder heads and combustion chambers.
- Conditions fuel to fight ethanol and water corrosion, upper cylinder to reduce friction and wear.
- Prevents future carbon buildup.
- Best for improved performance, fuel economy and reduced emissions in one fill up.

PRODUCT CODE  
**65 510016**



**GUMOUT FUEL INJECTOR/CARBURETOR CLEANER 60Z**

Carbon buildup from combustion can clog fuel injectors and carburetors, limiting the amount of fuel that reaches the engine. Gumout Fuel Injector & Carburetor Cleaner keeps deposits from forming on these crucial parts to maintain performance and fuel economy.

- Helps save fuel.
- Prevents deposits.

PRODUCT CODE  
**65 510021**



**GUMOUT GAS TREATMENT 60Z**

Humidity and condensation can cause water to accumulate in the fuel system, corroding key engine parts. Gumout® Gas Treatment removes water from fuel to improve fuel quality and helps extend the life of engine parts.

- Improves fuel quality.

PRODUCT CODE  
**65 510018**



**GUMOUT OCTANE BOOSTER 296ML**

All engines are calibrated to run on fuel with a specific octane rating. In vehicles with knock sensors, lower octane gas can retard timing, reducing performance and fuel economy. Gumout Octane Booster raises the octane level in gas to restore proper combustion and performance.

- Boosts octane rating.
- Best for stopping knocks and pings.
- Reduces emissions.

PRODUCT CODE  
**65 510022**



**GUMOUT FUEL INJECTOR CLEANER 177ML**

When carbon deposits build up on fuel injectors, intake valves and ports, it can cause engines to hesitate, surge or lose power. Gumout Fuel Injector Cleaner removes carbon deposits from these key engine parts to maximize engine performance and fuel economy.

- Cleans port/indirect fuel injectors, intake valves and ports.
- Prevents future carbon buildup on port/indirect fuel injectors, intake valves and ports.
- Best for maximized performance, fuel economy and reduced emissions.

PRODUCT CODE  
**65 510019**



**GUMOUT HIGH MILEAGE FUEL SYSTEM CLEANER 177ML**

Engines with over 75,000 miles can suffer from extensive carbon deposits and excess friction. Gumout Regane High Mileage Fuel System Cleaner reduces friction in the upper cylinder to improve fuel economy.

- Cleans GDI/direct and port/indirect fuel injectors, intake valves and ports, piston tops, cylinder heads and combustion chambers.
- Conditions fuel to fight ethanol and water corrosion, upper cylinder to reduce friction and wear.
- Prevents future carbon buildup.
- Best for restored performance, fuel economy in high mileage vehicles and reduced emissions in just one fill-up.

PRODUCT CODE  
**65 510023**





**GUMOUT ALL-IN-ONE FUEL SYSTEM CLEANER/ETHANOL TREATMENT 12OZ**

Engine performance is affected by everything from carbon deposits and corrosion to heat and friction. Gumout All-In-One Complete Fuel System Cleaner uses P.E.A. (polyetheramine) to effectively remove carbon deposits other products can't for improved performance across the fuel system.

- Improves fuel economy.
- Fights rust & corrosion.
- Reduces friction and wear.
- Cleans entire fuel system.

PRODUCT CODE  
**65 510104**



**GUMOUT REGANE HIGH MILEAGE FUEL SYSTEM CLEANER 12OZ**

Engines with over 75,000 miles can suffer from extensive carbon deposits and excess friction. Gumout Regane High Mileage Fuel System Cleaner reduces friction in the upper cylinder to improve fuel economy and remove deposits.

- Cleans GDI/direct and port/indirect fuel injectors, intake valves and ports, piston tops, cylinder heads, combustion chamber.
- Conditions fuel to fight ethanol and water corrosion, upper cylinder to reduce friction and wear.
- Prevents future carbon build up.

PRODUCT CODE  
**65 510105**



**GUMOUT REGANE COMPLETE FUEL SYSTEM CLEANER 12OZ**

Even high-quality fuel can leave behind carbon deposits and corrosion from ethanol and water. Gumout Regane Complete Fuel System Cleaner conditions fuel against corrosion to help extend the life of key engine parts.

- Maximizes fuel economy.
- Improves horsepower.
- Cleans entire fuel system.

PRODUCT CODE  
**65 510106**



**GUMOUT DIESEL ALL-IN-ONE FUEL TREATMENT 296ML**

Engine performance is affected by everything from carbon deposits and corrosion to heat and friction. Gumout All-In-One Complete Fuel System Cleaner uses P.E.A. (polyetheramine) to effectively remove carbon deposits other products can't for improved performance across the fuel system.

- Improves Fuel Economy.
- Fights Rust & Corrosion.
- Reduces Frictions & Wear.
- Cleans Entire Fuel System.

PRODUCT CODE  
**65 510152INTL**



**GUMOUT REGANE PARTS CLEANER/DEGREASER 16OZ**

Over time, a vehicles engine becomes covered with gum, varnish, and dirt build-up. Gumout Regane Parts Cleaner/Degreaser cleans and degreases all unpainted metal parts, carburetors, chokes, intakes, throttle bodies, brake drums, brake rotors and calipers.

- Removes Gum, varnish and dirt build-up that can cause hard starting, rough idling, stalling, high emissions, and loss of power.
- Leaves brakes clean for smoother, fast and more dependable braking performance.
- Quickly cleans all unpainted metal surfaces.
- Fast drying.
- Contains no CFC's or chlorinated solvents.

PRODUCT CODE  
**65 540001**



**GUMOUT REGANE DIRECT INJECTION INTAKE VALVE & PORT CLEANER 11OZ**

Gasoline Direct Injection (GDI) systems have unique carbon build-up issues on intake valves and ports. The professional strength formula ensures valves and ports in GDI/direct Injection and standard injection systems are cleaned.

- Remove Deposits from GDI intake valves.
- Quickly restores lost performance.

PRODUCT CODE  
**65 540023**



**GUMOUT JET SPRAY CARBURETOR/CHOKE & PARTS CLEANER 16OZ**

Overtime, carburetors and choke valves can become clogged with gum, varnish and dirt, affecting performance. Gumout® Carb/Choke & Parts Cleaner quickly removes these deposits from the inside and outside of the carburetor to improve engine performance and fuel economy.

- Helps stop hard starting & rough idling.

PRODUCT CODE  
**65 800002230**



**GUMOUT JET SPRAY CARB CHOKE CLEANER 397GR**

Overtime, carburetors and choke valves can become clogged with gum, varnish and dirt, affecting performance. Gumout Carb/Choke & Parts Cleaner quickly removes these deposits from the inside and outside of the carburetor to improve engine performance and fuel economy.

- Cleans carburetors, linkage, choke valves and unpainted metal parts.
- Best for improved performance, fuel economy and reduced emissions.

PRODUCT CODE  
**65 800002231**



**GUMOUT JET SPRAY CARB CHOKE CLEANER 170GR**

The carburetors and choke valves in small engines are especially prone to gum, varnish and dirt buildup because of less frequent use. Gumout Small Engine Carb + Choke Cleaner quickly removes these deposits from the inside and outside of the carburetor.

- Cleans carburetors, linkage and choke valves.
- Best for improved performance, fuel economy and reduced emissions.

PRODUCT CODE  
**65 800002241**



**SLICK 50 SUPERCHARGED SYNTHETIC ENGINE TREATMENT**

Slick 50, inventors of the engine treatment introduce Slick 50 Supercharged Synthetic Engine Treatment. Now in a pour and drive formula, Slick 50's Supercharged technology fights performance robbing friction 18% better than the leading synthetic motor oil alone.

- Protects against power robbing friction, heat and wear.
- Enhances oil durability.
- Cleans and prevents sludge.
- Fights ethanol water damage.

PRODUCT CODE  
**65 750001**



**SLICK 50 RECHARGED HIGH MILEAGE ENGINE TREATMENT**

Slick 50 Recharged High Mileage Engine Treatment was developed for vehicles that suffer from lost performance due to friction & wear, oil consumption & leaks, smoking, and sludge build-up. It is formulated to restore the performance of your high mileage vehicle.

- Protects against power robbing friction, heat and wear.
- Revitalizes seals to help stop oil leaks.
- Cleans and prevents sludge.
- Enhances emission system durability.

PRODUCT CODE  
**65 750002**



**DRI LUBE HANDY STICK**

Dri Lube is a petroleum based dry lubricant in a handy stick form. The stick with 1000 uses. Simply rub it on. It lubricates, stops squeaks, prevents rust, loosens sticking drawers and windows plus many other uses.

- Prevents rust.
- Does not soil clothing.

PRODUCT CODE  
**67 DL**



**WILDCAT  
MEGA FLOW FILTER 77MM**

The fine mesh increases the amount of air flow, straightens the flow and stops sucking hot air from high temperature engine compartment. Gain instant horsepower with this product by improving the filtration process.

- Honeycomb steel mesh cover over foam.
- Width: 160mm.
- Height: 80mm.
- Neck: 77mm.

PRODUCT CODE  
**36 WS24577B** BLUE  
**36 WS24577R** RED



**WILDCAT  
MINI AIR FILTER**

This filter provides a high volume flow of clean and cooler free air into the engine crankcase. Improves fuel economy, and virtually helps increasing horsepower by bringing in cold dense air, instead of hot oil fumes.

- Mini oil breather filter.
- Supplied with hose clip for easy installation.
- Manufactured from advanced polyurethane.
- Can be used in extreme temperatures.
- Removes carbon particles before venting.

PRODUCT CODE  
**36 MF12** 12MM  
**36 MF18** 18MM  
**36 MF20** 20MM  
**36 MF25** 25MM

**WILDCAT  
POD FILTER 77MM**

The filter will improve overall air filtration, horse power, torque and gas mileage over stock filters. It helps to draw more air into your engine to improve throttle response and enhance horsepower.

- Oiled, pleated cotton cloth for maximum filtration.
- Width: 160mm.
- Height: 130mm.
- Neck: 77mm.

PRODUCT CODE  
**36 WS00277BL** BLACK  
**36 WS00277C** CHROME  
**36 WS00277CF** CARBON FIBRE  
**36 WS00277R** RED

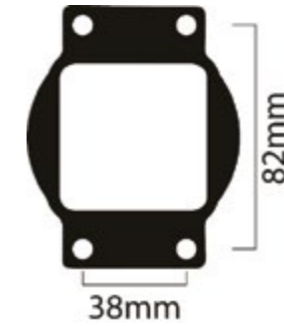

**WILDCAT  
POD ADAPTOR  
SUITS MOST BMW MAZDA  
& SOME TOYOTA**

More cold air coming into your vehicle will help the performance of your engine, meaning more power! This bolts onto your factory airflow meter and on the other end of this pod filter adaptor you put your pod filter.

- Plastic adaptor to suit 77mm pod filters.
- Length: 82mm.
- Width: 38mm.
- Suits: Most BMW, most Mazda, some Toyota.

PRODUCT CODE  
**36 PAB**

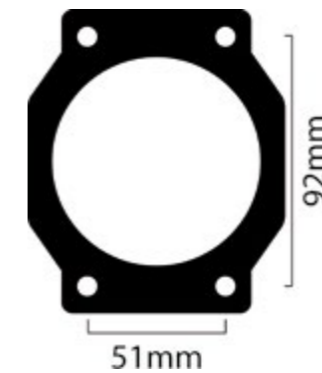

**WILDCAT  
POD ADAPTOR  
SUITS NISSAN SENTRA,  
SKYLINE, PRIMERA**

More cold air coming into your vehicle will help the performance of your engine, meaning more power! This bolts onto your factory airflow meter and on the other end of this pod filter adaptor you put your pod filter.

- Plastic adaptor to suit 77mm pod filters.
- Length: 92mm.
- Width: 51mm.
- Suits: Nissan Sentra, Skyline, Primera.

PRODUCT CODE  
**36 PAN2**

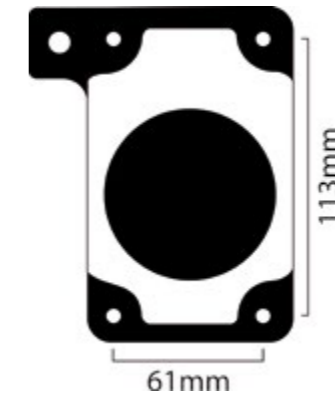

**WILDCAT  
POD ADAPTOR  
SUITS MOST MITSUBISHI  
& MOST 77MM POD FILTERS**

More cold air coming into your vehicle will help the performance of your engine, meaning more power! This bolts onto your factory airflow meter and on the other end of this pod filter adaptor you put your pod filter.

- Plastic adaptor to suit 77mm pod filters.
- Length: 113mm.
- Width: 61mm.
- Suits: Most Mitsubishi.

PRODUCT CODE  
**36 PAM**

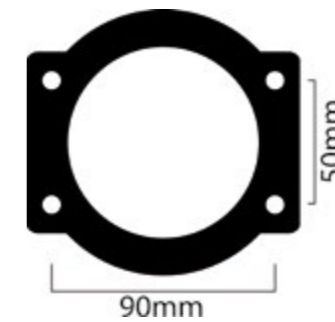

**WILDCAT  
POD ADAPTOR  
SUITS SUBARU LEGACY IMPREZA  
TO 97 WRX**

More cold air coming into your vehicle will help the performance of your engine, meaning more power! This bolts onto your factory airflow meter and on the other end of this pod filter adaptor you put your pod filter.

- Plastic adaptor to suit 77mm pod filters.
- Length: 50mm.
- Width: 90mm.
- Suits: Subaru Legacy, Impreza to 97, WRX 96-99.

PRODUCT CODE  
**36 PAS1**





**WILDCAT  
BONNET RELEASE/CHOKE  
CABLE KIT 120 INCH**

The choke cable kit is a super attractive way to provide a polished and finished look to any carburettor installation. The choke cables are designed to perform well using high quality materials engineered for optimum fit and function.

- Features a 120 inch braided cable.
- Universal fitment.

PRODUCT CODE  
**47 CC120**



**WILDCAT  
BONNET RELEASE/CHOKE  
CABLE KIT 72 INCH**

The choke cable kit is a super attractive way to provide a polished and finished look to any carburettor installation. The choke cables are designed to perform well using high quality materials engineered for optimum fit and function.

- Features a 72 inch braided cable.
- Universal fitment.

PRODUCT CODE  
**47 CC72**



**GATOR  
INSPECTION CAMERA  
WITH 2.3IN DISPLAY**

The Wired Inspection Camera is ideal for surveying hard-to-reach places. Rated IP67 waterproof, G5000 is equipped with a 2.31-inch TFT LCD monitor that has an adjustable brightness feature. G5000 is lightweight and easy-to-use.

- Mini waterproof camera with 980-millimetre (3-foot) flexible extended tube.
- Manufactured and tested to IP67 waterproof standards.
- Adjustable brightness on lens-mounted LED light.
- Lightweight, hand-held, flexible and convenient-to-use design.
- Hook, mirror and magnet accessories included.

PRODUCT CODE  
**47 G5000**



**WILDCAT  
OIL FILTER WRENCH**

The wrench helps to make the installation of the tubing or oil filter replacement work with high efficiency and comes with serrated jaws that give you a superior grip.

- Serrated jaws for maximum grip.
- Adjusts to fit filters from 65mm to 95mm.
- Easy operation.
- The oil wrench adjusts to fit filters from 65mm to 95mm.

PRODUCT CODE  
**47 TOF**



**WILDCAT  
OIL CATCH TANK  
BLACK 400CC**

The oil catch tank can catch the oil and moisture in the blow-by gas that causes carbon and sludge build-up in the intake system and the engine, keeping dirt and oil from getting inside the engine.

- 400 CC capacity.
- Maintains life and efficiency of engine.
- Stops blow by and catches excess oil.
- Includes hose and fittings.

PRODUCT CODE  
**36 CTPOL**



**WILDCAT  
RADIATOR OVERFLOW  
RECOVERY UNIT**

The radiator overflow recovery unit aims to meet or exceed the performance of the original equipment they replace. The unit can withstand high pressure and tries to ensure that the vehicle will be free from coolant leaks.

- Suitable for 13 psi to 16 psi radiators.
- Eliminates the need to fill radiator directly.
- Maintains coolant at maximum level.
- Easily installed.

PRODUCT CODE  
**47 WRU1**



**WILDCAT  
BLADE FUSE ASSORTMENT**

Protect your car and your electrical device from short circuit or overload. Transparent for quick detection of blown fuses and coloured coded for confident and easy installation. Contains 5A, 10A, 15A, 20A, 25A and 30A blade fuses.

- Packed in a plastic display case.

PRODUCT CODE  
**91 PXP100 BLADE FUSES**  
**91 PXP101 MINI BLADE FUSES**



**WILDCAT  
BLACK HEAT SHRINK TUBING  
ASSORTMENT**

This heat shrink tubing is ideally suitable for electrical insulation, wire bundling, colour coding, mechanical protection, wire/cable joints and daily repairs etc. The heat activated adhesive lining provides impermeable seal to salt water and other liquids.

- Packed in a plastic display case.
- Black pre-shrunk tubing 2mm to 13mm.

PRODUCT CODE  
**91 PXP103**



**WILDCAT  
ELECTRICAL TERMINAL ASSORTMENT**

A handy assortment of terminals and joiners included for quick electrical repairs.

- Contains joiners, blade, ring & spade terminals.
- Packed in a plastic display case.

PRODUCT CODE  
**91 PXP105**



**WILDCAT  
FLAT & SPRING WASHER ASSORTMENT**

An assorted box containing a range of washers from 4mm to 20mm.

- Packed in a plastic display case.

PRODUCT CODE  
**91 PXP120**



**WILDCAT  
TAP WASHERS ASSORTMENT**

An assorted box containing O-Rings, faucet, rubber siphon, foam gaskets, fibre, aluminium, c-clips and flat rubber washers.

- Packed in a plastic display case.

PRODUCT CODE  
**91 PXP123**



**WILDCAT  
RUBBER GROMMETS ASSORTMENT**

An assorted box containing grommets to suit hole sizes from 6.4mm to 25.4mm.

- Packed in a plastic display case.

PRODUCT CODE  
**91 PXP130**



**WILDCAT  
O-RINGS ASSORTMENT**

An assorted box containing O-rings from 1mm to 4mm in diameter.

- Packed in a plastic display case.

PRODUCT CODE  
**91 PXP131**



**WILDCAT  
SPLIT PINS ASSORTMENT**

An assorted box containing split pins from 1.6x4mm to 4x63.5mm.

- Packed in a plastic display case.

PRODUCT CODE  
**91 PXP132**



**WILDCAT  
BLANK RUBBER GROMMETS  
ASSORTMENT**

These rubber grommets are made of quality, flexible and durable rubber material, they are of good electric resistance capability. And the rubber o-rings will fit those drill holes precisely and efficiently.

- Sizes from 8mm to 25.4mm.
- Packed in a plastic display case.

PRODUCT CODE  
**91 PXP200**



## CAR CARE

Rain-X Car Care .....	151
Rain-X Cleaning Accessories .....	154
Rain-X Brushware .....	155
Dirty Steve Car Care.....	156
Black Magic Car Care .....	158
Michelin Car Care.....	158
Blue Magic Metal Polish .....	159
Kenco Brushware & Sponges .....	160
Kenco Towels, Cloths & Chamois.....	161
Plasti Dip Rubber Coating .....	162
Aerosol Spray Can Trigger Handle .....	162
Plasti Dip Vinyl Repair Kit.....	163
Plasti Dip Liquid Tape .....	163





**APPLY TO GLASS.  
DEFY THE ELEMENTS.**



**OUTSMART THE ELEMENTS™**  
Visit [rainx.co.nz](http://rainx.co.nz)



**RAIN-X  
GLASS WATER REPELLENT 255G**

The Rain-X Glass Water-Repellent Aerosol brings you all of the performance you have come to expect and love from the original Rain-X glass treatment to an aerosol version to make the application process faster and easier.

- Easier and faster to apply Rain-X water-beading magic: Simply spray on and wipe off.
- Instant activation. No hazing and buffing required!
- Works even on wet windshields.
- Dramatically improves wet weather driving visibility.
- Repels rain and reduces the adhesion of sleet and snow.

PRODUCT CODE  
**64 630167**



**RAIN-X  
GLASS WATER REPELLENT 340G**

Rain-X Glass Water Repellent dramatically improves all-weather visibility, safety and driving comfort. Perfect for use on all glass conditions, wet or dry. The new easy-to-use aerosol spray can makes prepping your car's glass and windshield a whole lot faster.

- Easier and faster to apply Rain-X water-beading magic: Simply spray on and wipe off.
- Instant activation. No hazing and buffing required!
- Works even on wet windshields.
- Dramatically improves wet weather driving visibility.
- Repels rain and reduces the adhesion of sleet and snow.

PRODUCT CODE  
**64 630168**



**RAIN-X  
WATER REPELLENT**

Drive safer in wet weather conditions with Rain-X's Glass Water Repellent. It dramatically improves your visibility while driving in rain, sleet and snow. Simply apply the treatment to exterior glass and watch the raindrops fly off your windshield while driving.

- Improve all-weather visibility, safety and driving comfort.
- Helps easily remove frost, ice, salt, mud and bugs.

PRODUCT CODE  
**64 80002245 103ML**  
**64 80002250 473ML TRIGGER BOTTLE**



**RAIN-X  
PLASTIC RAIN REPELLENT 355ML**

Watch water bead up and roll away on motorcycle windscreens, goggles, visors and boat windshields for improved visibility as this product helps in enhancing visibility in rainy conditions. Applies water beading technology to dramatically enhance visibility.

- Specifically formulated for plastic surfaces.
- Easily applied, durable coating.
- Great for boats, motorbike helmets and goggles.
- Clean and dry surfaces before treating. Spray directly onto plastic surfaces or onto a clean, dry cloth. Wipe using a firm, circular and overlapping motion. Wipe off and buff with a clean, dry cloth.

PRODUCT CODE  
**64 620036**



**RAIN-X  
ANTI-FOG 103ML**

Just spray on the windshield or apply to a clean towel, spread, let it haze and wipe for a fog free glass. Use on the inside of your vehicles windows, as well as on helmet visors, sun control films, mirrors etc.

- Removes smoke residue.
- For use on automotive and marine interior glass.
- Also great for bathroom mirrors.

PRODUCT CODE  
**64 BCAF21112**



**RAIN-X  
2-IN-1 GLASS CLEANER  
WITH RAIN REPELLENT 680ML**

Rain-X glass cleaner applies water beading technology to enhance your driving visibility in one simple step. Helps prevent and remove sleet, snow, ice, bugs, and road spray from sticking to glass. Repels rain by causing water to bead up and roll away.

- Streak free glass cleaner with rain repellent.
- Improves wet weather driving visibility.
- Easy to use. Just spray on and wipe away.

PRODUCT CODE  
**64 5071268**



**RAIN-X GLASS CLEANER TRIGGER 680ML**

This glass cleaner delivers automotive strength cleaning for glass and mirrors leaving a streak-free, clean shine. The concentrated formula quickly and easily cuts through dirt, bug residue, tree sap and road grime on exterior glass. Use the formula on interior glass to remove smoke film or protectant over spray. It is safe for all permanently tinted windows.

- Easy to use. Just spray on and wipe away.
- Use on interior and exterior glass.

PRODUCT CODE  
**64 630018**



**RAIN-X AUTOMOTIVE GLASS CLEANER 539G**

Rain X Glass Cleaner delivers automotive strength cleaning for glass and mirrors leaving a streak-free, clean shine! The concentrated formula quickly and easily cuts through dirt, bug residue, tree sap and road grime on exterior glass.

- Part of the family of #1 glass cleaners.
- Cleans to a streak-free shine by cutting through road-trip bug residue, dirt and grime while being safe for tinted windows.
- Delivers automotive strength glass cleaning.
- Outperforms leading glass cleaners at removing tough bug residue.
- Formulated to be safe for OEM tinted windows.

PRODUCT CODE  
**64 630175**



**RAIN-X GLASS TREATMENT WIPES PK25**

Rain-X 2-in-1 Glass Cleaner + Rain Repellent improves wet weather driving visibility and is easy to use! The Glass Cleaner applies water beading technology to enhance your driving visibility in one simple step.

- 2-in-1 formula cleans and repels rain.
- Applies water beading technology to enhance driving visibility.
- Fast and easy to use - just spray on and wipe away with no buffing required.
- Helps prevent and remove sleet, snow, ice, bugs and road spray from sticking to glass.
- Cleans automotive glass streak-free.

PRODUCT CODE  
**64 630022**



**RAIN-X HEADLIGHT RESTORER 148ML**

Over a period of time, plastic headlights become oxidized rendering them hazy and yellow. This causes headlights to shine less brightly, which is dangerous for the driver and others on the road. Save money by restoring headlights instead of replacing them.

- Helps restore clear plastic by removing haze.
- Improves visibility with clearer headlight lenses.

PRODUCT CODE  
**64 800001810**



**RAIN-X WASHER FLUID ADDITIVE 500ML**

Simply add Rain-X washer fluid additive to water or any windshield washer fluid and apply. Enhances driver visibility, safety and comfort.

- Improves windshield cleaning.
- Rain drops bead up and are blown away.

PRODUCT CODE  
**64 RX11806D**



**RAIN-X SPOT FREE CAR WASH 1.42L**

A specially formulated car wash formula that leaves a spot free shine without the need of hand drying. This car wash contains a unique blend of rinsing polymers, causing water to sheet off the vehicle for fast air drying.

- Eliminates the drying step, saving time.
- Spot-free formula sheens water off vehicle.
- Deep cleaning, high foam soap cuts through dirt.

PRODUCT CODE  
**64 620034**



**RAIN-X X-TREME CLEAN GLASS SCRUB 355ML**

This glass cleaner removes harsh build-up from windshields and headlights to deliver ultimate driving visibility! The formula renews glass and plastic quickly and easily removing dirt, bugs, and road grime for an ultimate, streak-free clean.

- Removes haze and discoloration from windshields and headlights.
- Glass cleaner gently strips away heavy residue.
- Improves driving visibility and wiper performance.

PRODUCT CODE  
**64 5080217**



**RAIN-X WINDSHIELD REPAIR KIT**

Rain-X Windshield Repair Kit helps you minimize the appearance and stop the spread of chips and cracks in your windshield. It removes air from the break, fills it with durable resin and makes it even stronger than before.

- For best results, repairs should be made as soon as possible after the damage occurs and before the break is contaminated by dirt or water.
- The kit works best on round damage not more than one inch in diameter, and cracks not longer than 12 inches.
- Repairs all types of laminated windshields.
- Easy to use, multiple-use kit.
- Super strong, durable resin fills the cracks.

PRODUCT CODE  
**64 600001**



**RAIN-X HEADLIGHT RESTORATION KIT**

Over time, headlight lenses become oxidized rendering them hazy and yellow. This causes headlights to shine less brightly, which is dangerous for the driver and others on the road. The Rain-X headlight restoration kit provides a deep clean to yellowed, hazed headlights.

- Helps restore clear plastic by removing haze and discoloration.
- Improves visibility with clearer headlight lenses.
- Multi-step kit provides a deeper cleaning process than single step products.
- Save money by restoring headlights instead of replacing them.

PRODUCT CODE  
**64 800001809**



**RAIN-X CERAMI-X DETAILER 650ML**

Rain-X Cerami-X Detailer Premium HydroShield Polymer Blend formula provides superior water repellence, UV protection, and long-lasting shine & protection for exterior painted surfaces, trim & chrome. It's non-abrasive formula that gives superior glossy shine and colour intensity.

- No streaking formula.
- Superior water repellency and UV protection.
- Premium hydroshield polymer blend formula.

PRODUCT CODE  
**64 620161**



**RAIN-X SHOWER DOOR EXTREME CLEAN 354ML**

Rain-X Shower Door X-treme Clean removes harsh build-up on glass shower doors to deliver the ultimate in sparkling clean. This unique product, specially formulated for use on glass shower doors, is ideal for removing soap scum, dirt etc.

- Provides an extreme clean for glass shower doors.
- Leaves a sparkling finish.
- Ideal for use before Rain-x Water Repellent.

PRODUCT CODE  
**64 630035**



**RAIN-X SHOWER DOOR REPELLENT 473ML**

Rain-X Glass Water Repellent uses advanced technology that causes water to bead and slide off on glass surfaces. Regular use helps prevent hard water stains, soap scum and grime build-up on your glass shower door - keeping it looking clean.

- Helps prevent soap scum, hard water deposit and grime build up on glass shower doors.
- Easy to apply.
- Durable long lasting coating.

PRODUCT CODE  
**64 630023**



OUTSMART THE ELEMENTS™

**66 RXJS  
JUMBO SPONGE**

- Gentle on paintwork
- Quality soft foam
- Super sudsing
- Hard wearing



**66 RXWM  
WASH MITT**

- Scratch free wipe
- Super absorbent
- Hold tons of soap and suds
- Designed for any hand size
- Ideal for SUVs, cars, boats and motorbikes.



**66 RXDT  
DRYING TOWEL**

- Premium ultra-soft drying towel
- Super absorbent
- Scratch-free wipe
- Ideal for SUVs, cars, vans, boats, trucks and RVs
- Size: 130 x 75cm



**66 RXCHL  
LARGE CHAMOIS**

- 100% genuine leather for effective drying
- Absorbs up to four times its weight in water
- Naturally gentle streak-free finish
- 2.5 sq/ft



**66 RXWCD  
EXTENDABLE  
WINDOW CLEANER**

- Triangle car windshield and dashboard cleaner
- Extendable handle inside windshield cleaning tool
- Great for the hard to reach glass of the vehicle interior
- Includes two microfibre covers



**66 RXSQS  
SQUEEGEE**

- Flexible silicone blade design provides a smooth, resistance-free swipe
- Curved easy to hold handle with comfortable feel grip
- Leaves surface streak-free
- Perfect for use on windows, mirrors, shower doors and any large flat surface
- Convenient hang hole for drying and storage



**66 RXEXTMOP13  
EXTENDABLE AUTO  
WASH MOP**

- The ultimate extendable microfibre wash mop
- Adjustable to 1.3m
- Ideal for SUVs, cars, vans, boats, trucks and RVs



**66 RXEXTSQ13  
EXTENDABLE  
SQUEEGEE**

- Nylon netting with heavy-duty sponge
- Adjustable handle
- Extends to 1.3m
- Wiper with rubber blade



**66 RXCWB  
AUTO BRUSH  
HOSE CONNECTION**

- Soft bristles
- Connects to any standard garden hose fitting
- Ideal for cleaning cars
- Instant on/off switch saves water



**66 RXWBLH  
AUTO WHEEL BRUSH  
HOSE CONNECTION**

- Super soft brush head
- Features foam grips for extra control
- Ideal for SUVs, cars, vans, boats, trucks and RVs
- Water control valve
- Quick connect hose adaptor



**66 RXWBM  
MAG WHEEL  
SPOKE BRUSH**

- Soft scratch-free, sturdy bristles remove dirt and grime with minimal effort
- Designed to remove mud and road grime from mag wheel spokes
- Rubber handle for the perfect grip



**66 RXWBD  
WHEEL WASH BRUSH**

- Bristles deliver safe and gentle cleaning
- Great for tyres, wheels, rims, inner fenders
- Removes caked on grime and grease
- Heavy duty non-slip rubber handle for the perfect grip
- Designed to get into hard to reach areas



**66 RXEXT21  
EXTENDABLE BRUSH  
HOSE CONNECTION**

- Soft tip bristles
- Adjustable telescopic handle - extends to 2.1m
- Water control valve
- Quick connect hose adaptor
- Ideal for SUVs, cars, vans, boats, trucks, RVs and home



**66 RXEXT16  
EXTENDABLE BRUSH  
REMOVABLE HEAD  
HOSE CONNECTION**

- Soft tip bristles
- Adjustable telescopic handle - extends to 1.6m
- Quick connect hose adaptor
- Ideal for SUVs, cars, vans, boats, trucks, RVs and home
- Removable brush head for hand-held cleaning

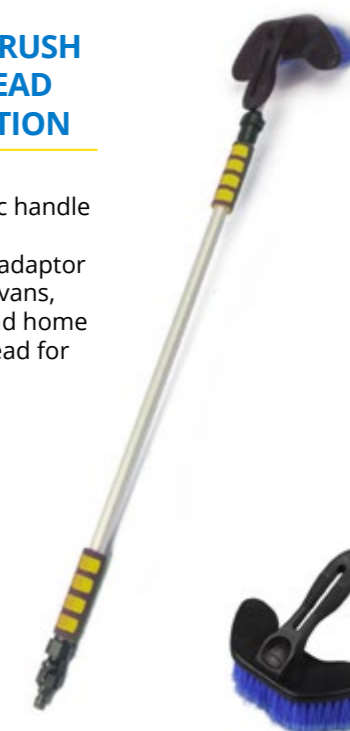



**DIRTY STEVE  
RADICAL RUST PROTECTOR**

A lanolin based lubrication for use on external metallic surfaces including vehicles, heavy machinery, trailers.

- Spray on multi-purpose lubrication.
- Machinery component protection.
- Long life coating application for storage.
- Industrial lubricant.
- Corrosion prevention.
- Spray on anti-seize.

PRODUCT CODE  
**62 DS1020**



**DIRTY STEVE  
VINYL REVITALISER**

Revitalise all vinyl surfaces with Dirty Steve's 'Vinyl Revitaliser'. Suitable for use on exterior plastic, rubber and vinyl, this formula is engineered to prevent UV damage and rejuvenate surfaces.

- Revives and protects exterior vinyl and plastics.
- Protection for vinyl roofs, ute tonneaus, car bras, bimini tops, black plastic trim, motor bike seats, boat seats and rubber mats.
- Will not create premature aging, cracking, greying, chalking or fissures.
- Leaves a new looking, mid sheen finish.
- 100% free of oil and water based silicones as well.
- pH neutral, safe for long term use, including stitching.
- Great for renewing engine bay plastics and rubber hoses.
- Stops vinyl UV yellowing and excessively fast ageing.
- Enriches and renews older vinyl, plastic and rubber.

PRODUCT CODE  
**62 DS1030**



**DIRTY STEVE  
BANANA FOAMING WASH  
+ CERAMIC INFUSION**

Designed to lift and remove dirt, salt, and other contaminants from external surfaces with little effort, Dirty Steve Banana Foaming Wash is engineered specifically for use on marine vessels, for removal of salt and corrosion prevention & general maintenance.

- Ceramic infused formula for extra protection.
- Streak free, no residue and cleans without stripping wax.
- Compatible with Dirty Steve foaming applicator gun.
- A pleasant banana scent.
- Features safe PH levels of 7.5 - 8.5.
- Contains bio-degradable surfactants.

PRODUCT CODE  
**62 DS1010**



**DIRTY STEVE  
FOAMING APPLICATOR GUN**

The Foaming Applicator Gun is a quick and easy way to get a deep clean of your valued possessions from the comfort of your home with a standard garden hose access. Ideal for exterior maintenance cleaning of your automotive or marine vehicles.

- Easy connection to standard garden hoses.
- Ideal for foaming wash, foaming degreaser & salt eliminator application.
- Adjustable spray intensity.
- Foaming barrel nozzle.
- Ideal for general maintenance clean of cars, boats, dirt bikes and more.

PRODUCT CODE  
**62 DS1001**



**DIRTY STEVE  
STRAWBERRY FOAMING DEGREASER**

Dirty Steve Strawberry Foaming Degreaser is engineered specifically to assist in removing built up oil, grease & tough grime including chain lube residue, waterproof grease & other stubborn contaminants from external surfaces.

- Assists in removing oil, grease & grime.
- Works on tough grime including chain lube residue, waterproof grease & other stubborn contaminants.
- Apply directly to dry surfaces, rinse within 30 seconds.
- Compatible with Dirty Steve foaming applicator gun.
- A pleasant strawberry scent.
- Features safe PH levels of 12.0 - 12.5.
- Contains bio-degradable surfactants.

PRODUCT CODE  
**62 DS1011**



**DIRTY STEVE  
MARINE ENGINE FLUSH APPLICATOR**

The innovative Dirty Steve Marine Engine Flush Applicator allows for 100ml of Dirty Steve Engine Flush & Salt Eliminator Solution to be injected directly into engines of boats, jet-skis and personal watercraft, flushing out salt deposits that may remain inside the engine.

- Removes salt and other contaminants from marine engines.
- Prevents salt corrosion.
- Easy connection to garden hoses.
- Use in conjunction with Dirty Steve Engine Flush & Salt Eliminator solution.
- Container provides measurements for accuracy when filling with salt eliminator solution.

PRODUCT CODE  
**62 DS1013**



**DIRTY STEVE  
PEPPERMINT ENGINE FLUSH  
& SALT REMOVER**

Designed for flushing marine engines, removing salt & a general salt wash for marine watercrafts & equipment. Perfect for general maintenance cleaning of boats, jet-skis, trailer or surface that may come into contact with corrosive salty sea air.

- Flexible to be used as a salt wash for surfaces and marine engine flush for all marine watercraft.
- Helps protect against corrosive salty sea air by dissolving salt deposits on surfaces and inside engines.
- Designed for use with our Dirty Steve engine flush applicator.
- Compatible with Dirty Steve foaming applicator gun for use as a general salt wash.
- A pleasant & fresh peppermint scent.
- This solution features safe PH levels of 9.5 - 10.0.
- Contains bio-degradable surfactants.

PRODUCT CODE  
**62 DS1012**





**BLACK MAGIC  
TYRE WET  
GEL 473ML**

Providing the best shine out of all Black Magic Tyre Wet products, this gel utilizes an advanced silicone formula to last longer and shine brighter than other products on the market.

- Long-lasting intensity. Weather and rinse-resistant formula keeps your tyres looking black and glossy for weeks, not days.
- Self-healing formula automatically fills in small scuffs and maintains a smooth, black shine.
- The thick, clinging Black Magic formula adheres to the tyres to produce minimal sling.
- Clear formula leaves behind no white powdery residue - just pure wet shine.

PRODUCT CODE  
**67 5072647**



**BLACK MAGIC  
TYRE WET  
AEROSOL FOAM 510GR**

Black Magic Tyre Wet Foam cleans, shines and protects in just one step. Simply spray and walk away! Specially formulated thick foam clings to the tyre to dissolve and release dirt, road grime and mud.

- Long-lasting intensity. Weather and rinse-resistant formula keeps your tyres looking black and glossy for weeks, not days.
- Clear formula leaves behind no white powdery residue - just pure wet shine.
- The thick, clinging Black Magic formula adheres to the tyres to produce minimal sling.

PRODUCT CODE  
**67 800002220**



**BLACK MAGIC  
FACTORY BLACK TRIM  
& PLASTIC RESTORER KIT**

The Black Magic Factory Black Trim Restorer will have your trim looking black and refreshed in no time. Factory Black restores faded trims & plastics to like-new look that lasts with InviArmour Technology.

- Restores faded trims & plastics to like-new look that lasts.
- Protects against fading.
- Provides a dark, rich shine with a long lasting shine.
- No harsh chemical smells.

PRODUCT CODE  
**67 120164**



**MICHELIN  
TYRE SHINE TRIGGER SPRAY 650ML**

The Michelin Tyre Wheel Shine has a sophisticated nozzle equipped with a pre-compression trigger that dispenses liquid efficiently at a high velocity. This single bottle of 650ml can dress up to 40 tyres when used optimally.

- The sophisticated nozzle equips a pre-compression trigger that dispenses liquid efficiently at a high-velocity.
- Can dress up to 40 tyres. Wash and dry tyres prior to application. Apply by spraying liquid onto a sponge or cloth and wipe it around the tyre wall.
- Formulated based on a silicone emulsion. It is anti-static and reduces the build-up of static charge on the surface.
- Adds a long-lasting finish and renders a new look and sheen to the tyres. Its no-fling formula prevents the liquid from flinging over the fenders and body panels.
- This tyre shine bottle contains 650ml.

PRODUCT CODE  
**67 31371**



**MICHELIN  
WHEEL CLEANER  
TRIGGER SPRAY 650ML**

Fully tested acid free wheel cleaner offering superior cleaning and safety. Effectively removes brake dust, tar, salt, mud and other residue from the brake blocks. Safe to use with all types of rims and hub caps.

- Acid free safe on all types of wheels.
- PH balance formula.
- Removes brake dust.
- Pre-compression trigger.
- REACH standard.
- MVDS available.

PRODUCT CODE  
**67 31418**



**MICHELIN  
TYRE SHINE  
AEROSOL 520ML**

This aerosol creates a glossy look on your car tyres, to make them look brand new.

- No fling formula
- Anti-static
- Adds a glassy look
- Easy application aerosol

PRODUCT CODE  
**67 31432**



**BLUE MAGIC  
METAL POLISH CREAM  
TUB**

Non abrasive, for home, auto, marine, polished, seals brass, copper, sterling silver, aluminium. Adds extra shine to your product and provides lasting protective coating. For all metal surfaces, brass, copper, sterling silver, aluminium, stainless steel and gold.

- Non-Abrasive.
- Can be used with buffers and polishers.
- Provides a lasting protective coating.

PRODUCT CODE  
**69 400 200G**  
**69 500 500G**



**BLUE MAGIC  
METAL POLISH CREAM  
100G TUBE**

Restores a showroom shine to chrome & aluminium wheels, bumpers and all automobile and truck chrome. Removes oxidation, tarnish and dirt while it polishes. Polishes stainless steel and is safe for fibreglass finishes.

- Use on brass, copper, silver, aluminium and more
- Non-Abrasive
- Removes tarnish and oxidation
- Can be used with buffers and polishers
- Provides a lasting protective coating

PRODUCT CODE  
**69 100**



**MICHELIN  
SUPER CONCENTRATED  
SCREEN WASH 250ML**

The Michelin screen wash liquid is a powerful and fragrant windscreen cleansing solution for your vehicle. It cleanses and leaves the windscreen sparkling and is ideal for getting rid of even the toughest of residues.

- Makes up to 25 litres.
- Removes road grime and insects.
- Forest scent.
- HDPE single neck measuring bottle 250ml.

PRODUCT CODE  
**64 31999**



**MICHELIN  
WINDOW DE-ICER  
650ML SPRAY**

Cut down the time scraping the ice from the glass with this fast-acting de-icer. Effects seen within 5 seconds to quickly remove frost and frozen snow. The de-icer works effectively even in temperatures down to -40°C.

- Fast acting.
- High power 360 degree spray head.
- Safe on all types of glass, plastic, paintwork and rubber.
- Cut down the time scraping the ice from the glass.

PRODUCT CODE  
**64 31319**



**BLACK MAGIC  
TYRE WET  
TRIGGER SPRAY 680ML**

Black Magic Tyre Wet uses only one gentle mist to give your tyres an ultimate long-lasting wet glossy black look. Tyre Wet is specially formulated to deliver the most brilliant shine of any leading tyre spray available.

- Deepest shine of any leading tyre spray.
- Unique combination of polymers and high-molecular-weight silicones provide long-lasting, high-gloss shine.
- Leaves tyres looking wet, black and glossy - better than new.
- Incredibly easy to use. No wiping: just ready, aim, shine.

PRODUCT CODE  
**67 BM23**



**BLACK MAGIC  
NO SCRUB WHEEL CLEANER  
TRIGGER SPRAY 680ML**

Great looking rims make your vehicle stand out. Black Magic No Scrub All Wheel Cleaner dissolves brake dust, dirt and road grime quickly and easily. Its powerful formula improves the appearance of all types of wheels without hazing or discolouration.

- Specially formulated to safely clean all wheel types.
- Easily removes brake dust, dirt & grime.
- Safe on all wheel types and improves the appearance your wheels without hazing or discolouration.
- Gentle chemistry is safe for use on ABS plastic, chrome, aluminium, wire, and mag wheels with clear coat, polished, painted or anodized finish.
- Ideal for preparing wheel for polishing.

PRODUCT CODE  
**67 BM41023**



**KENCO BODY & WHEEL BRUSH**

The body and wheel brush is a unique brush that is soft on sensitive surfaces yet strong enough to remove tough dirt and grime. The bristles get deep into cracks and crevices making this brush perfect for cleaning your wheels.

- Heavy duty bristles.
- Durable.
- Knuckle saving handle.
- Ideal for cleaning car, home or boat.

PRODUCT CODE  
**66 KBWBWH**



**KENCO PREMIUM DOUBLE LOOP WHEEL BRUSH**

Deluxe bristles are flexible and chemical-resistant. Our brush is durable and will last for ages. Soft rubber handle offers comfort and functionality and will not harm your wheel or rims. Dual bristle loops for easy removal of dirt.

- Easy grip comfort handle.

PRODUCT CODE  
**66 KBWW**



**KENCO SOFT BRISTLE SPRAY & WASH BRUSH**

The spray and wash brush is a multifunctional cleaning brush. The spray and wash brush with super soft bristles is ideal for cleaning your car, home or boat. The brush connects to any standard garden hose fitting.

- Super soft bristles.
- Connects to any standard garden hose fitting.
- Instant on/off switch saves water.
- Ideal for cleaning car, home or boat.

PRODUCT CODE  
**66 KBWWSPW**



**KENCO EXTENDABLE HANDLE SOFT BRISTLE FLOW-THRU BRUSH 1.65M**

The handle flow through brush has soft tip bristles that clean without scratching. The long extendable handle allows you to clean hard-to-reach surfaces. Perfect for larger vehicles - SUV's, RV's, trucks and trailers.

- Soft tip bristles.
- Adjustable telescopic handle - extends to 1.65M.
- Water control valve.
- Quick connect hose adaptor.
- Ideal for cleaning car, home or boat.

PRODUCT CODE  
**66 KBWEFT165**



**KENCO EASY GRIP GIANT SPONGE**

This large sponge is designed to clean large surfaces faster. It is made from durable material that lasts long and offers better grip with wet hands. This sponge is easy to use and maintain. Ideal for cleaning car, home or boat.

- Super sudsing.
- Easy grip.
- 290mm x 155mm.

PRODUCT CODE  
**66 KSPG**



**KENCO EASY GRIP JUMBO SPONGE**

This large sponge is designed to clean large surfaces faster. It is made from durable material that lasts long and offers better grip with wet hands. This sponge is easy to use and maintain. Ideal for cleaning your car, home or boat.

- Super sudsing.
- Easy grip.
- 220mm x 115mm.

PRODUCT CODE  
**66 KSPJ**



**WILDCAT ICE SCRAPER**

This ice scraper removes the toughest of ice and snow with its extra sharp blade without leaving scratches. The ice scraper is extra convenient as it fits directly inside the glove compartment.

- Compact design.
- Quickly removes ice from your car's windscreen.

PRODUCT CODE  
**66 SCR010**



**KENCO SOFT MICROFIBRE TOWELS 6 PACK**

Attracts and lifts out dirt and dust. Use wet or dry. Hypoallergenic. Machine washable. Ideal for cleaning car, home or boat.

- Dimensions: 40cm x 30cm
- 6 pack

PRODUCT CODE  
**66 KCPMT6PC**



**KENCO STREAK FREE MICROFIBRE GLASS CLEANING CLOTH**

Smooth microfibre. Special corners to clean hard to reach areas. Soft and gentle cleaning action. Lint and streak free results. Ideal for cleaning car, home or boat.

PRODUCT CODE  
**66 KCTGC**



**KENCO SOFT & ABSORBENT POLISHING CLOTH 1M**

Kenco polishing cloth measuring: 100cm x 35cm.

- Soft and absorbent
- Waxing
- Dusting
- Polishing

PRODUCT CODE  
**66 KPP1M**



**KENCO HYDRO PVA CHAMOIS LARGE**

This super absorbent chamois is of the highest quality and lasts longer than all other synthetic chamois. This chamois is resistant to chemicals, solvents, grease and oil and is soft and gentle on all surfaces.

- Machine washable.

PRODUCT CODE  
**66 KHCLG**



**KENCO GENUINE OIL TANNED LEATHER CHAMOIS**

This genuine leather chamois is made of premium oil tanned leather. The chamois is fully absorbent and offers a streak free finish. Ideal for windows, mirrors and painted surfaces.

- Oil tanned leather.
- Thick and soft.

PRODUCT CODE  
**66 KLC225**



**KENCO GENUINE OIL TANNED LEATHER CHAMOIS**

This genuine leather chamois is made of premium oil tanned leather. The chamois is ideal for windows, mirrors and painted surfaces.

- Thick and soft.
- Streak free finish.
- Fully absorbent.

PRODUCT CODE  
**66 KLC375**



**PLASTI DIP  
MULTI-PURPOSE RUBBER COATING  
AEROSOL - GLOSSIFIER**

Specially designed to make the already-outstanding Plasti Dip home solution even better. The Enhancers are easy to use and will give any Plasti Dipped item a unique look and dries to a soft, satin finish.

- Exhibits excellent moisture, acid, alkaline, and abrasion resistance.
- Protects against electrical shock, skidding, slipping, and corrosion.
- Remains flexible and stretchy, and will not become brittle or crack even in extreme weather conditions.

PRODUCT CODE  
**68 11212 GLOSSIFIER**



**PLASTI DIP  
MULTI-PURPOSE RUBBER COATING  
AEROSOL**

Plasti Dip is a synthetic rubber based coating that's perfect for do-it-yourself projects around the home, garage, garden or shop. Plasti Dip is used widely for automotive detailing; coating wheels; and painting graphics that can be peeled off without affecting the car's OEM finish.

- Resists moisture, acids, and alkalines
- Protects against electrical shock
- Anti-Skid, Anti Slip, Abrasion resistant
- Remains flexible and stretchy
- Will not become brittle or crack even in extreme weather

PRODUCT CODE  
**68 11201 RED**  
**68 11203 BLACK**  
**68 11207 WHITE**  
**68 11209 CLEAR**  
**68 11221 GUNMETAL GREY**



**PLASTI DIP  
MULTI-PURPOSE RUBBER COATING  
AEROSOL - GLOSS BLACK**

Plasti Dip Gloss Black Spray provides a Gloss Black finish without the need for a separate Gloss Top Coat. Plasti Dip is a synthetic rubber based coating that's perfect for do-it-yourself projects around the home, garage, garden or shop.

- One step glossy process, no gloss top coat needed
- Peel-able and easy to remove from most surfaces when ready
- Anti-Skid, Anti Slip, Abrasion resistant
- Remains flexible and stretchy
- Will not become brittle or crack even in extreme weather
- Resists moisture, acids, and alkalines
- Protects against electrical shock

PRODUCT CODE  
**68 11297 GLOSS BLACK**



**PLASTI DIP  
MULTI-PURPOSE RUBBER COATING  
AEROSOL - METALLIC BLACK SAPPHIRE**

Plasti Dip Luxury Metal Colours bring you the eye catching metallic colours found on fine luxury automobiles. Durable, flexible and waterproof, Luxury Metal Plasti Dip protects your things and gives them that mark of elegance.

- Resists moisture, acids, and alkalines
- Protects against electrical shock
- Anti-Skid, Anti Slip, Abrasion resistant
- Remains flexible and stretchy
- Will not become brittle or crack even in extreme weather

PRODUCT CODE  
**68 11350 BLACK SAPPHIRE METALLIC**



**PLASTI DIP  
MULTI-PURPOSE RUBBER COATING  
429ML**

Multi-purpose rubber coating aerosol is comfortable to hold with its non-slip controlled grip. Areas of application gain protection from moisture, acids, and corrosion. Provides protection from shock, vibration, and heat.

- Multi purpose rubber coating.
- Insulates surfaces.
- Durable.
- 429ML.

PRODUCT CODE  
**68 11601 RED**  
**68 11602 YELLOW**  
**68 11603 BLACK**  
**68 11604 BLUE**



**PLASTI DIP  
MULTI-PURPOSE RUBBER COATING  
AEROSOL - CAMO GREEN**

Plasti Dip Camo matte colour to blend with nature. Durable, flexible and waterproof Plasti Dip protects your equipment while reducing its visibility.

- Remains flexible and stretchy
- Will not become brittle or crack even in extreme weather

PRODUCT CODE  
**68 11217 CAMO GREEN**



**PLASTI DIP  
MULTI-PURPOSE RUBBER COATING  
AEROSOL - BLAZE ORANGE**

Blaze Orange is an eye-catching fluorescent colour that stand out from the crowd. Durable, flexible and waterproof, protects your equipment from the elements while increasing its visibility.

- Will not become brittle or crack even in extreme weather

PRODUCT CODE  
**68 11218 BLAZE ORANGE**



**PLASTI DIP  
MULTI-PURPOSE RUBBER COATING  
AEROSOL - SMOKE**

Smoke is a semi-translucent grey product. Can be used for tinting or applications where a darker, but see through finish is desired. Creates a matte finish - not gloss.

- Resists moisture, acids, and alkalines
- Will not become brittle or crack even in extreme weather

PRODUCT CODE  
**68 11220 SMOKE**



**PLASTI DIP  
LIQUID TAPE AEROSOL SPRAY 170G - BLACK**

This liquid tape spray is a flexible, synthetic rubber coating, which exhibits excellent moisture, acid, alkaline, and abrasion resistance. The spray will not unravel like electrical tape.

- Spray-on insulation coating.
- Superior formula will not crack, peel or harden.
- Seals out moisture and salt permanently.
- Colour: Black.

PRODUCT CODE  
**68 16003**



**PLASTI DIP  
VLP LEATHER VINYL REPAIR 29ML**

VLP is a clear, high strength leather and vinyl repair designed to mend small rips, tears, and holes in most types of vinyl and leather materials. A repair made with VLP is stronger than the original vinyl or leather material.

- High strength vinyl and leather repair.
- Flexible, waterproof and weather resistant.

PRODUCT CODE  
**68 61Z09**



**PLASTI DIP  
BRUSH ON LIQUID TAPE 118ML**

Brush on liquid electrical tape, 4 oz can simply brush on this liquid electrical tape and give it 5 minutes to set - just like using electrical tape. Forms a tough, flexible coating on metal, rubber and plastic. Will not crack or unravel.

- Rubber coating used as electrical tape.
- Convenient applicator brush in cap.
- Will not unravel like electrical tape.
- Superior formula will not crack, peel or harden.
- Seals out moisture and salt permanently.

PRODUCT CODE  
**68 LET14Z03 BLACK**  
**68 LET14Z01 RED**

**PLASTI DIP  
AEROSOL SPRAY CAN TRIGGER HANDLE**

Lightweight trigger handle that snaps on to any standard spray can to provide fatigue free accuracy and control over your painting project. To install you only need to place the front lip of the spray handle into the valve mounting cup of the can. Full grip trigger for effortless spraying.

PRODUCT CODE  
**68 02012**





## INTERIOR COVERINGS

Seat Covers .....	166
All Blacks Seat Covers.....	168
Caterpillar Seat Covers.....	168
R.M. Williams Seat Covers.....	169
Tradies Seat Covers .....	172
Carpet Mats .....	174
All Blacks Carpet Mats .....	175
R.M. Williams Carpet Mats.....	175
All Weather Mats.....	176
All Blacks All Weather Mats .....	177
Caterpillar All Weather Mats.....	177
R.M. Williams All Weather Mats .....	177
Vehicle Specific All Weather Mats .....	178





**WILDCAT**  
**ALPINE PLUSH GREY HIGH BACK FRONT SEAT COVER PAIR**

Protect against spills, stains, fading, dirt and wear and tear and extend the life of your vehicle seats. These car seat covers are made of plush fur, giving the user comfort as well as a durable product.

- Quality seat covers.
- Universal fit - fits most vehicles.
- Plush fur.
- Extra comfort.
- 1 year quality guarantee.

PRODUCT CODE  
**55 APHBTL GREY**  
**55 APHBTB BLACK**



**WILDCAT**  
**CLASSIC GREY FRONT SEAT COVER PAIR**

Protect against spills, stains, fading, dirt and wear and tear and extend the life of your vehicle seats. These car seat covers are made from velour and a foam backing thus giving the user comfort as well as a durable product.

- Colour: Classic grey, with black fleck.
- Velour side panels and a foam backing.
- Durable, high quality acrylic material.
- Slip on installation.
- Sold per pair.

PRODUCT CODE  
**55 CLFHBG**



**WILDCAT**  
**GTX GREY FRONT SEAT COVER PAIR**

Protect against spills, stains, fading, dirt and wear and tear. The GTX car seat covers are made from quality foam backed acrylic thus giving the user comfort as well as a durable product.

- Colour: Grey square pattern, black side panels.
- Quality foam backed acrylic.
- Easy to fit to most bucket seats.
- Sold per pair.

PRODUCT CODE  
**55 GTXFHBG**



**WILDCAT**  
**CANVAS BLACK 4 PIECE FRONT & REAR SEAT COVER PACK**

Protects your original car seats against spills, dirt and daily wear. Transforms the look and feel of the interior of your car instantly. Simple to Install. Flat cloth with foam backing makes the material washable and breathable.

- High quality, durable cotton-canvas.
- Machine washable.
- Foam backed for extra comfort.
- Complete front and rear set of covers.

PRODUCT CODE  
**55 CV4PCBL**



**WILDCAT**  
**CANVAS FRONT SEAT COVER PAIR BLACK SIZE 60**

Protects your Original car seats against spills, dirt and daily wear. Transform the look and feel of the interior of your car instantly. Simple to Install. Flat cloth with foam backing makes the material washable and breathable.

- High quality, durable cotton-canvas.
- Side airbag compatible.
- Foam backed for extra comfort.
- Map pockets for extra storage.
- Sold per pair.

PRODUCT CODE  
**55 CV60BL**



**WILDCAT**  
**ROADSTAR GREY FRONT SEAT COVER PAIR**

Extend the life of your vehicle and improve the appearance of old or dirty seats. Protect your seats against spills, stains, fading, dirt and wear and tear while giving you comfort as well as a durable product.

- High quality, durable polypropylene.
- Universal fit, slip on installation.
- Easy to maintain and clean.
- Sold per pair.
- Matching rear cover available.

PRODUCT CODE  
**55 RSFHBG**



**WILDCAT**  
**ROADSTAR GREY REAR SEAT COVER**

It is made specifically to protect your original factory seat covers from excessive wear caused by children, pets and from other heavy duty uses. Great for construction or work type vehicles.

- High quality, durable polypropylene.
- Universal fit.
- Easy to maintain and clean.
- Slip on installation.
- Matching front cover available.

PRODUCT CODE  
**55 RSRG**



**WILDCAT  
FRONT SEAT COVER PROTECTOR BLACK 1PC**

Easily installed in seconds and removed in seconds, effortlessly folded and stored away. Perfect for pets, use under baby seats to prevent damage, great to use after going outdoors. Superior quality, plush and soft for a comfortable feel.

- Made from durable, waterproof PVC.
- Easy install - simply slips over head rest.
- Sold as a single unit.

PRODUCT CODE  
**55 SP1BL**



**ALL BLACKS  
SEAT COVER PAIR**

Support the All blacks in comfort and style with this pair of seat covers. The seat covers are made of a high quality foam backed fabric.

- Universal fit.
- Side airbag compatible.
- Sold per pair.

PRODUCT CODE  
**55 ABSC170**



**R.M. WILLIAMS  
CANVAS FRONT SEAT COVERS SIZE 30**

R.M. Williams seat covers are designed to protect your vehicles interior seats and provide ultimate resistance against dirt, mud, water and sand. The canvas seat covers also offer three storage pockets on the back.

- Polyester / Canvas material.
- Extra thick foam backed.
- Waterproof.
- Stylish addition to any interior.

PRODUCT CODE  
**55 CVMW16BLK30 BLACK**  
**55 CVMW16GRY30 GREY**



**CATERPILLAR  
CANVAS FRONT SEAT COVER PAIR BLACK SIZE 30**

The Caterpillar Icon canvas seat covers provide premium fabrication all over and the ultimate fit. The airbag compatible seat covers suit most seats with or without airbags and have a buckle tie system for easy fitment.

- Official CAT licenced merchandise.
- Premium 50% cotton / 50% polyester canvas.
- Waterproof backing.
- Size 30 universal front seat covers.
- Buckle Tie System for easy fitment.
- Airbag Compatible Seat Covers to suit most seats with or without impact airbags.
- Neotex 350gsm Side panel fabric.

PRODUCT CODE  
**55 CVCATBLK30**



**CATERPILLAR  
POLYESTER CANVAS FRONT SEAT COVER PAIR BLACK SIZE 30**

The Caterpillar Icon canvas seat covers provides premium fabrication all over and the ultimate fit. The airbag compatible seat covers suit most seats with or without airbags and have a buckle tie system for easy fitment.

- Official CAT licenced merchandise.
- 100% polyester canvas.
- Waterproof backing.
- Neotex 350gsm side panel fabric.
- Size 30 universal front seat covers.
- Buckle tie system for easy fitment.
- Airbag compatible seat covers to suit most seats with or without impact airbags.

PRODUCT CODE  
**55 PCCATGRY30**



**R.M. WILLIAMS  
JACQUARD FRONT SEAT COVERS BLACK SIZE 30**

Specifically designed for R.M. Williams, made from a durable woven fabric with a timeless look to compliment your vehicle's interior. Neotex is triple the industry standard keeping your seat covers fitting snug and protecting your seats for longer.

- Front pair.
- High quality woven jacquard fabric.
- Airbag compatible.
- Extra thick foam backing.
- Rear map pockets.
- Easy to fit buckle system.

PRODUCT CODE  
**55 JCRMW16BLK30**



**R.M. WILLIAMS  
JACQUARD FRONT SEAT COVERS BLACK SIZE 60**

Specifically designed for R.M. Williams, made from a durable woven fabric with a timeless look to compliment your vehicle's interior. Neotex is triple the industry standard keeping your seat covers fitting snug and protecting your seats for longer.

- Front pair.
- High quality woven jacquard fabric.
- Airbag compatible.
- Extra thick foam backing.
- Rear map pockets.
- Easy to fit buckle system.

PRODUCT CODE  
**55 JCRMW16BLK60**



**R.M. WILLIAMS**  
**MESH FRONT SEAT COVERS BLACK SIZE 30**

R.M. Williams Canvas Car Seat Covers are designed to protect your vehicle's interior seats, providing resistance from dirt, mud, water & sand. Add a stylish touch and new look to your car's interior with these high-quality durable seat covers.

- Extra thick foam backing.
- High quality mesh fabric.
- Rear pockets.
- Easy to fit buckle system.

PRODUCT CODE  
**55 MHRMW16BLK30**



**R.M. WILLIAMS**  
**MESH BACK SEAT COVER BLACK SIZE 06**

R.M. Williams Canvas Car Seat Covers are designed to protect your vehicle's interior seats, providing resistance from dirt, mud, water & sand. Add a stylish touch and new look to your car's interior with these high-quality durable seat covers.

- Extra thick foam backing.
- Lined for seat protection.
- Rear pockets.
- Easy to fit buckle system.
- High quality mesh fabric.

PRODUCT CODE  
**55 MHRMW16BLK06**



**R.M. WILLIAMS**  
**VELOUR FRONT SEAT COVERS BLACK SIZE 30**

R.M. Williams Canvas Car Seat Covers are designed to protect your vehicle's interior seats, providing resistance from dirt, mud, water & sand. Add a stylish touch and new look to your car's interior with these high-quality durable seat covers.

- Suede Velour Seat Cover.
- Storage pockets on the back of the seat.
- Extra thick foam backing.
- Buckle fitting for easy installation.

PRODUCT CODE  
**55 VLRMW16BLK30**



**R.M. WILLIAMS**  
**VELOUR REAR SEAT COVERS BLACK SIZE 06**

R.M. Williams Canvas Car Seat Covers are designed to protect your vehicle's interior seats, providing resistance from dirt, mud, water & sand. Add a stylish touch and new look to your car's interior with these high-quality durable seat covers.

- Suede Velour Seat Cover.
- Storage pockets on the back of the seat.
- Extra thick foam backing.
- Buckle fitting for easy installation.

PRODUCT CODE  
**55 VLRMW16BLK06**



**DANGER**  
**TRADIES**  
**SEAT COVERS**

TRADIES  
CANVAS SEAT COVERS

VEHICLE DETAILS	ROW	PICTURE #	GREY	BLACK
FORD EVEREST (UA) TREND, TITANIUM, AMBIENTE SUV 2015-ON	FRONT	102C	56 RPG1003.TRG	56 RPG1003.TRB
FORD RANGER (PX) XL SINGLE CAB, BUCKET SEATS 2011-ON	FRONT	102C	56 RPG1003.TRG	56 RPG1003.TRB
FORD RANGER (PX) XL, XLT SUPER CAB 2011-ON	FRONT	102C	56 RPG1003.TRG	56 RPG1003.TRB
FORD RANGER (PX) DUAL CAB, ALL BADGES 2011 - 05/2015	FRONT	102C	56 RPG1003.TRG	56 RPG1003.TRB
	REAR	982	56 RPG5002.TRG	
FORD RANGER (PX) XL SINGLE CAB, BUCKET & 3/4 BENCH 2011 - 2015	FRONT	401	56 RPG1067.TRG	
FORD RANGER (PX) DUAL CAB, ALL BADGES (EXCL. RAPTOR) 06/2015-ON	FRONT	102C	56 RPG1003.TRG	56 RPG1003.TRB
	REAR	907	56 RPG5001.TRG	56 RPG5001.TRB
FORD RANGER (PX) DUAL CAB, RAPTOR 09/18-ON	REAR	907	56 RPG5001.TRG	56 RPG5001.TRB
HOLDEN COLORADO (RG) SNGL CAB, ALL BADGES, BUCKET SEATS 2012-ON	FRONT	102C	56 RPG1004.TRG	
HOLDEN COLORADO (RG) SPACE CAB, ALL BADGES 2012-ON	FRONT	102C	56 RPG1002.TRG	56 RPG1002.TRB
HOLDEN COLORADO (RG) LTZ DUAL CAB 2012 -8/2014	FRONT	102C	56 RPG1002.TRG	56 RPG1002.TRB
	REAR	1044	56 RPG5014.TRG	
HOLDEN COLORADO (RG) DUAL CAB, ALL BADGES 09/2014-ON	FRONT	102C	56 RPG1002.TRG	56 RPG1002.TRB
	REAR	1044	56 RPG5014.TRG	
HOLDEN COLORADO (RG) LX, LT DUAL CAB 2012 - 8/2013	FRONT	102C	56 RPG1002.TRG	56 RPG1002.TRB
HOLDEN COLORADO (RG) LX, LT DUAL CAB 9/2013 - 8/2014	FRONT	102C	56 RPG1002.TRG	56 RPG1002.TRB
HOLDEN COLORADO 7 (RG) LT, LTZ, 7 SEAT WAGON 2013 - 2016	FRONT	102C	56 RPG1002.TRG	56 RPG1002.TRB
HOLDEN TRAILBLAZER (RG) LT, LTZ, Z71, 7 SEAT WAGON 10/2016-ON	FRONT	102C	56 RPG1002.TRG	56 RPG1002.TRB
HYUNDAI ILOAD (TQ) 3 SEATER, 6 SEATER VAN 2008-ON	FRONT	303	56 RPG1036.TRG	
ISUZU DMAX (TF) SPACE CAB SX 06/2012-ON	FRONT	102C	56 RPG1004.TRG	
ISUZU DMAX (TF) SPACE CAB LS, LS-U, LS-M 06/2012-ON	FRONT	102C	56 RPG1002.TRG	56 RPG1002.TRB
ISUZU DMAX (TF) SINGLE CAB, ALL BADGES 06/2012-ON	FRONT	102C	56 RPG1004.TRG	
ISUZU DMAX (TF) DUAL CAB SX 06/2012 - 2013	FRONT	102C	56 RPG1004.TRG	
ISUZU DMAX (TF) DUAL CAB LS, LS-U, LS-M, LS-TERRAIN 06/2012-ON	FRONT	102C	56 RPG1002.TRG	56 RPG1002.TRB
	REAR	1044	56 RPG5012.TRG	56 RPG5012.TRB
ISUZU DMAX (TF) DUAL CAB 4X2 SX 2014-ON	FRONT	102C	56 RPG1004.TRG	
ISUZU DMAX (TF) DUAL CAB 4X4 SX 2014-ON	FRONT	102C	56 RPG1002.TRG	56 RPG1002.TRB
	REAR	1044	56 RPG5012.TRG	56 RPG5012.TRB
ISUZU MU-X (UCR, UCS) LS-M, LS-T, LS-U SUV 2013-ON	FRONT	102C	56 RPG1002.TRG	56 RPG1002.TRB
MAZDA BT50 (UP, UR) XT SINGLE CAB BUCKET SEATS 2011-ON	FRONT	102C	56 RPG1003.TRG	56 RPG1003.TRB
MAZDA BT50 (UP, UR) XT SINGLE CAB BUCKET & 3/4 BENCH 2011-ON	FRONT	401	56 RPG1067.TRG	
MAZDA BT50 (UP, UR) XT, XTR FREESTYLE CAB 2011-ON	FRONT	102C	56 RPG1003.TRG	56 RPG1003.TRB
MAZDA BT50 (UP, UR) XT DUAL CAB 2011-ON	FRONT	102C	56 RPG1003.TRG	56 RPG1003.TRB
	REAR	982	56 RPG5002.TRG	
MAZDA BT50 (UP) XTR, GT DUAL CAB 2011 - 06/2015	FRONT	102C	56 RPG1003.TRG	56 RPG1003.TRB
	REAR	982	56 RPG5002.TRG	
MAZDA BT50 (UR) XTR, GT DUAL CAB 07/15-ON	FRONT	102C	56 RPG1003.TRG	56 RPG1003.TRB
	REAR	907	56 RPG5001.TRG	56 RPG5001.TRB

MITSUBISHI TRITON (MQ, MR) GLX, GLX+, GLX ADAS, GLS BLACKLINE DUAL CAB 05/2015-ON	FRONT	102C	56 RPG1016.TRG	56 RPG1016.TRB
	REAR	903	56 RPG5018.TRG	56 RPG5018.TRB
MITSUBISHI TRITON (MQ, MR) GLX CLUB CAB 05/2015-ON	FRONT	102C	56 RPG1016.TRG	56 RPG1016.TRB
MITSUBISHI TRITON (MQ, MR) EXCEED, GLS PREMIUM DUAL CAB 05/2015-ON	REAR	903	56 RPG5018.TRG	56 RPG5018.TRB
NISSAN NAVARA (D23, NP300) DX, RX SINGLE CAB 11/2015-ON	FRONT	102C	56 RPG1011.TRG	57 RPG1011.TRB
NISSAN NAVARA (D23, NP300) RX, ST, ST-X KING CAB 03/2015-ON	FRONT	102C	56 RPG1011.TRG	58 RPG1011.TRB
NISSAN NAVARA (D23, NP300) SERIES 1 & 2 DX, RX, ST, ST-X DUAL CAB 03/2015 - 10/2017	FRONT	102C	56 RPG1011.TRG	59 RPG1011.TRB
NISSAN NAVARA (D23, NP300) SERIES 3 & 4 RX, ST, ST-X DUAL CAB 11/2017-ON	FRONT	102C	56 RPG1011.TRG	60 RPG1011.TRB
	REAR	704	56 RPG5073.TRG	57 RPG5073.TRB
TOYOTA HILUX SR5 DUAL CAB 5/2005 - 5/2006	REAR	998	56 RPG5023.TRG	56 RPG5023.TRB
TOYOTA HILUX SR, SR5 DUAL CAB 6/2006 - 7/2009	REAR	998	56 RPG5023.TRG	56 RPG5023.TRB
TOYOTA HILUX SR, SR5 DUAL CAB (4 X 2 ONLY) 8/2009 - 6/2015	REAR	998	56 RPG5023.TRG	56 RPG5023.TRB
TOYOTA HILUX SR, SR5 DUAL CAB (4 X 4 ONLY) 8/2009 - 6/2015	FRONT	102C	56 RPG1001.TRG	56 RPG1001.TRB
	REAR	998	56 RPG5023.TRG	56 RPG5023.TRB
TOYOTA HILUX SR, SR5, ROGUE, RUGGED, RUGGED X DUAL CAB 7/2015-ON	FRONT	102C	56 RPG1005.TRG	56 RPG1005.TRB
	REAR	1061	56 RPG5029.TRG	56 RPG5029.TRB
TOYOTA HILUX SR, SR5 EXTRA CAB (4 X 4 ONLY) 7/2011 - 6/2015	FRONT	102C	56 RPG1001.TRG	56 RPG1001.TRB
TOYOTA HILUX WORKMATE, SR SINGLE CAB BUCKET SEATS 07/2015-ON	FRONT	110		56 RPG1035.TRB
TOYOTA HILUX WORKMATE, SR SINGLE CAB BUCKET SEATS (4X4 ONLY) 7/2011 - 6/2015	FRONT	102C	56 RPG1001.TRG	56 RPG1001.TRB
TOYOTA HILUX WORKMATE, SR, SR5 EXTRA CAB 7/2015-ON	FRONT	102C	56 RPG1005.TRG	56 RPG1005.TRB
TOYOTA HILUX WORKMATE DUAL CAB 5/2005 - 06/2015	REAR	998	56 RPG5023.TRG	56 RPG5023.TRB
TOYOTA HILUX WORKMATE DUAL CAB 7/2015-ON	FRONT	102C	56 RPG1005.TRG	56 RPG1005.TRB
VOLKSWAGEN AMAROK (2H) ALL BADGES EXCL. ULTIMATE 2/2011-ON	FRONT	102C		56 RPG1022.TRB
VOLKSWAGEN AMAROK (2H) ALL BADGES 2/2011-ON	REAR	1054		56 RPG5021.TRB

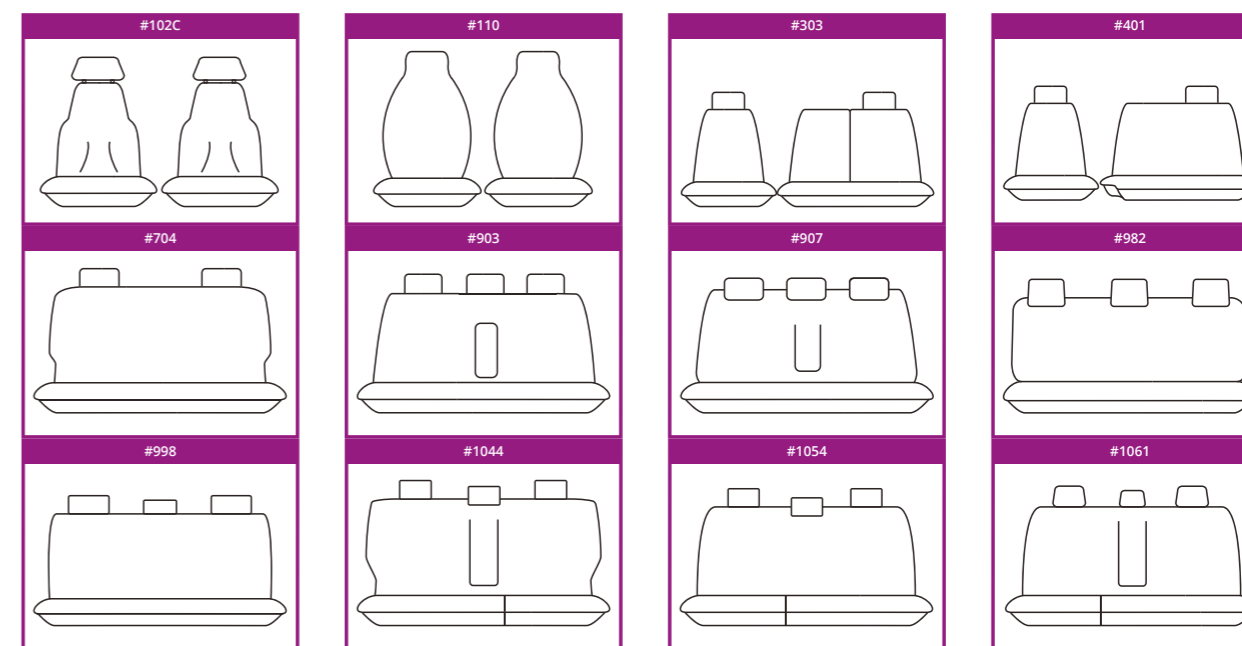





**WILDCAT  
BLACK CARPET SET OF 4 MATS  
3 STAR**

The 3 star black carpet vehicle floor mats give your car a fresh look and keep it neat and clean. The mats easily cover old, dirty or torn floor mats protecting your car's floors from dirt and spills.

- Fitted with driver's side heel pad.
- Non-slip rubber backing.
- Universal fit.
- Front Mat Dimensions: 620mm x 310mm.
- Rear Mat Dimensions: 310mm x 410mm.

PRODUCT CODE  
**14 CM10B**



**WILDCAT  
BLACK CARPET SET OF 4 MATS  
4 STAR**

The 4 star black carpet vehicle floor mats protects your car carpet against dirt and spills. Top surface of mat has textured design to prevent slipping while giving your car floor a new look.

- Fitted with driver's side heel pad.
- Non-slip rubber backing.
- Universal fit.
- Set of 4.
- Front Mat Dimensions: 650mm x 460mm.
- Rear Mat Dimensions: 390mm x 330mm.

PRODUCT CODE  
**14 CM22B**



**WILDCAT  
BLACK CARPET SET OF 4 MATS  
WITH DRIVER CHECKER PLATE PAD**

Black carpet vehicle floor mats give your car a fresh look and keep it neat and clean. The mats easily cover old, dirty or torn floor mats protecting your car's floors from dirt and spills.

- Drivers side checker plate heel pad.
- Anti-slip ribbed backing.
- Contoured design.
- Front Mat Dimensions: 650mm x 420mm.
- Rear Mat Dimensions: 280mm x 420mm.

PRODUCT CODE  
**14 CM21B**



**WILDCAT  
BLACK CARPET SET OF 4 MATS  
5 STAR**

The 5 star black carpet vehicle floor mats will keep car's floor neat and clean. The mats cover old dirty or torn floor mats thereby giving your car a new look.

- Drivers side checker plate heel pad.
- Universal fit.
- Non slip rubber backing.
- Front Mat Dimensions: 645mm x 465mm.
- Rear Mat Dimensions: 395mm x 330mm.

PRODUCT CODE  
**14 CM30B**



**ALL BLACKS  
BLACK CARPET SET  
4 MATS**

Show your support for the New Zealand All Blacks with this car carpet mat set. The set contains hard wearing carpet mats with the All Blacks logo.

- Driver side heel pad.
- Non-slip backing.
- Universal fit.
- Front: 650mm x 445mm. Rear: 440mm x 330mm.

PRODUCT CODE  
**14 ABFM850**



**R.M. WILLIAMS  
BLACK CARPET MATS SET OF 4**

R.M. Williams high-quality carpet car mats include trim lines for a creating a perfect custom fit for your vehicle. With a sleek design, these carpet floor mats include the signature R.M. Williams logo.

- Full seat carpet floor mats.
- Non-Slip backing.
- Durable quality carpet.
- Protects floors from dirt, stains and rain.
- Easy to fit.
- Perfect for any tradie, off-roader or an everyday commuter.

PRODUCT CODE  
**14 CMMRCLKS4**



**WILDCAT**  
**BLACK ALL WEATHER SET OF 4 MATS - 3 STAR**

The 3 star car floor mats protects your carpet from anything your shoes bring into the vehicle. The top surface of the mat has textured design to prevent slipping while giving your car floor a new look.

- Budget friendly.
- Hard wearing, contoured design.
- Anti-slip backing.
- Universal fit. Set of 4.
- Front Mat Dimensions: 625mm x 425mm.
- Rear Mat Dimensions: 425mm x 315mm.

PRODUCT CODE  
**14 RM10B**



**WILDCAT**  
**BLACK ALL WEATHER SET OF 4 MATS - 4 STAR**

The 4 star car floor mats protects your car, truck, or SUV with this premium quality set of 4 all weather floor mats. Your vehicle's interior is constantly under siege from the elements.

- Deluxe all-weather mats.
- Non slip backing.
- Universal fit. Set of 4.
- Front Mat Dimensions: 625mm x 425mm.
- Rear Mat Dimensions: 420mm x 350mm.
- Protect against mud, snow, water, and ice.

PRODUCT CODE  
**14 RM20B**



**WILDCAT**  
**HEAVY DUTY BLACK RUBBER 4WD MAT - LARGE**

Protect your vehicle's interior from even the most resilient blemishes such as dirt, spills, and other hardcore wear and tear with this heavy-duty all-weather floor mat. These non-skid floor mats are very easy to clean and durable.

- Deep dish design to suit 4x4 vehicles.
- Anti-slip backing.
- Includes trim lines for a custom fit.
- Dimensions: 780mm x 600mm x 30mm.

PRODUCT CODE  
**14 RM50**



**WILDCAT**  
**HEAVY DUTY BLACK RUBBER 4WD MAT - SMALL**

Protect your vehicle's interior from even the most resilient blemishes such as dirt, spills, and other hardcore wear and tear with this heavy duty all-weather floor mat. These non-skid floor mats are very easy to clean and durable.

- Deep dish design to suit 4x4 vehicles.
- Anti-slip backing.
- Includes trim lines for a custom fit.
- Dimensions: 510mm x 510mm x 30mm.

PRODUCT CODE  
**14 RM59**



**ALL BLACKS**  
**ALL WEATHER PAIR OF FRONT MATS**

Show your support for the mighty All Blacks with this hard wearing front rubber mat set.

- Hard Wearing.
- Protects your carpet.
- Anti-Slip Backing.
- Easy to clean.
- Fits Most Vehicles.
- Contoured Design.

PRODUCT CODE  
**14 ABRM019**



**R.M.WILLIAMS**  
**RUBBER FRONT MATS BLACK SET OF 2**

R.M. Williams high-quality rubber car mats include trim lines for creating a perfect custom fit for your vehicle. With a sleek design, these rubber floor mats include the signature R.M. Williams logo.

- Black rubber floor mats.
- Deep dish design to trap mud, dirt and water.
- Front pair.
- Trim lines - create a custom fit. Non-slip backing.
- Easy to clean. Heavy-duty design.
- Perfect for any tradie, off-roader or an everyday commuter.

PRODUCT CODE  
**14 CMRMWBKFR**



**CATERPILLAR**  
**BLACK RUBBER SET OF 2 FRONT MATS**

The Caterpillar heavy-duty rubber floor mats will keep your car clean and dry and will guard your car floor from damage. These mats provide superior protection for years against from spills, dirt, wear, tear and debris.

- Waterproof backing.
- Heavy-duty rubber floor mats.
- Deep dish design to trap mud and water.
- Trimmable edge.
- Heavy duty handle.

PRODUCT CODE  
**14 CMCATBLKFR**



**WILDCAT**  
**ALL WEATHER LINK MAT**

This all weather floor mat protects your vehicle's interior. The deep tread pattern protects against rain, snow and mud.

- All weather mat.
- Link design for grip.
- Fits cars, trucks, and SUVs.
- **Dimensions**  
Large: 600mm x 500mm  
Small: 500mm x 390mm

PRODUCT CODE  
**14 LINKL LARGE**  
**14 LINKS SMALL**

**WILDCAT**  
**ALL WEATHER FRONT & REAR MAT SETS**

The Wildcat Custom Fit Floor Mats perfectly match the interior of your vehicle offering you durability combined with a premium look. These mats are hard-wearing and have a slip-resistant backing which helps them maintain their position.

- Hard wearing.
- Protects your carpet against air, snow, mud and dust.
- Anti-slip backing.
- Easy to clean.



**WILDCAT**  
**ALL WEATHER FRONT & REAR MAT SET**  
**FORD RANGER 2012 ON**

- Suits: Ford Ranger 2012 onwards.

PRODUCT CODE  
**14 RMFR12**

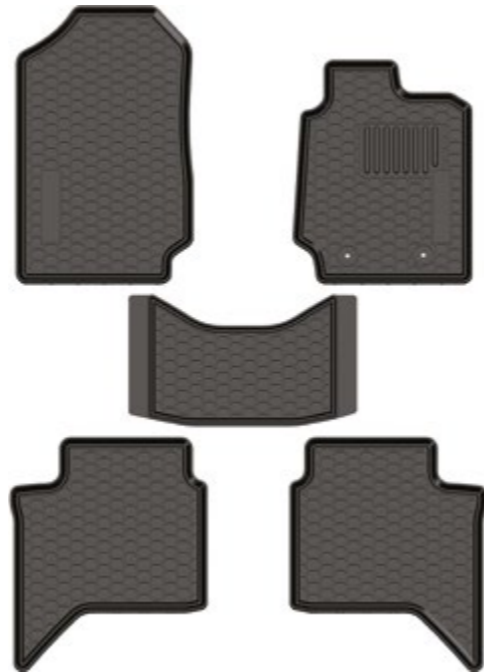

**WILDCAT**  
**ALL WEATHER DEEP DISH DOUBLE CAB MAT SET - FORD**  
**RANGER 2012 ON**

- Suits: Ford Ranger 2012 onwards.

PRODUCT CODE  
**14 RMFR12D**



**WILDCAT**  
**ALL WEATHER FRONT & REAR MAT SET**  
**D-MAX/COLORADO 2017 ON**

- Suits: Isuzu D-Max and Holden Colorado 2017 onwards.

PRODUCT CODE  
**14 RMIDM17**



**WILDCAT**  
**ALL WEATHER FRONT & REAR MAT SET**  
**MAZDA BT50 2016 ON**

- Suits: Mazda BT-50 2016 onwards.

PRODUCT CODE  
**14 RMMBT16**



**WILDCAT**  
**ALL WEATHER FRONT & REAR MAT SET**  
**MITSUBISHI TRITON 2017 ON**

- Suits: Mitsubishi Triton 2017 onwards.

PRODUCT CODE  
**14 RMMT17**



**WILDCAT**  
**ALL WEATHER FRONT & REAR MAT SET**  
**NISSAN NAVARA 2016 ON**

- Suits: Nissan Navara 2016 onwards.

PRODUCT CODE  
**14 RMNN16**



**WILDCAT**  
**ALL WEATHER FRONT & REAR MAT SET**  
**TOYOTA HILUX AUTO 2016 ON**

- Suits: Toyota Hilux 2016 onwards.

PRODUCT CODE  
**14 RMTH16**



## EXTERIOR ACCESSORIES

Window Tint.....	183
Steering Wheel Covers .....	184
Seat Belt Pads.....	185
Keys & Remotes .....	187
Wiper Blades & Refills .....	214
Funnels.....	218
Oil Drain Pans.....	219
Fuel Siphons & Transfer Pumps.....	219
2-Stroke Mixing Tool.....	219
Pinstripes .....	220
Badges.....	221
Decal Stickers .....	222
Vinyl Wrap.....	223
Wheel Rim Accent Trim .....	224
Front & Rear Spoilers .....	225
Air Scoop Vents .....	226
Mesh .....	227
Hood Pin Kits .....	227
Tape.....	228
Car & Tyre Covers .....	229
Number Plate Frames .....	229
Mirrors.....	230
Registration & WOF Holders.....	230
Trailer & Towing Accessories.....	231
Tie Downs .....	231
Wheel Clamp .....	232
Breakdown Kit.....	232
Tow Rope .....	232
Universal Fuel Cap .....	232
Anti-Static Strap.....	232
Solder .....	233
Mud Flaps .....	233
Cigarette Lighter Kit.....	233
Air Pumps.....	235
Tyre Gauges, Valves & Tools.....	236
Tyre Repair Kits .....	237
Valve Caps.....	238
Wheel Nuts .....	238
Wheel Brace.....	239

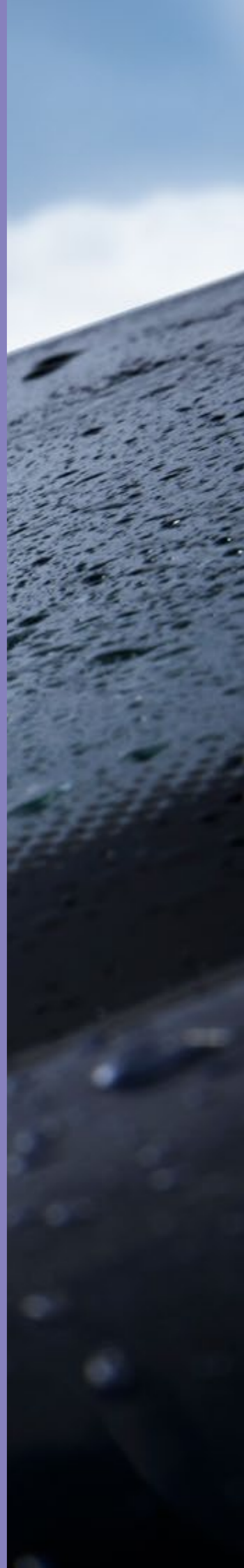



**WILDCAT  
PROFESSIONAL  
WINDOW TINT**

Give your car windows a richer, more professional look with the Wildcat professional window tint. This window tint effectively blocks the solar heat radiation, creating a cooler, more comfortable interior environment. The professional grade tint has an extra metallised layer that reflects heat.

- Low reflective film.
- Blocks 97% of harmful UV rays.
- Scratch resistant for longer life.
- Includes: instructions, knife and squeegee.
- Dimensions: 50cm x 3m.

PRODUCT CODE  
**17 50000** 5%  
**17 50001** 15%  
**17 50002** 35%



**WILDCAT  
PREMIUM  
WINDOW TINT**

Our premium window tint allows for maximum heat rejection for your vehicle. It also gives your car a stylish look with outstanding and superior quality. Our professional 5% tint film rejects heat, UV rays and glare coming through your windows.

- Premium, scratch resistant.
- Filters UV - reduces glare.
- Keeps interior cool, reduces fading, extra security.
- Includes: instructions, knife and squeegee.
- Dimensions:  
Standard: 51cm x 3m.  
Tall: 76cm x 3m.

PRODUCT CODE  
**17 60005** 5%  
**17 60015** 15%  
**17 60035** 35%

PRODUCT CODE - TALL  
**17 65005** 5%  
**17 65015** 15%  
**17 65035** 35%



**WILDCAT  
STATIC REMOVABLE  
WINDOW TINT**

Enhance the look of your car while adding a protective layer to the windows to help keep out harmful UV rays and scorching heat. Static window tint is easy to install and remove as it contains no glue.

- Removable and reusable cling tint film.
- 5% Tint.
- No Adhesives.
- Immediate results.
- Increases privacy.
- Blocks UV rays.
- Reduces glare and fading.
- No special skills required.
- Dimensions: 51cm x 1.8m.

PRODUCT CODE  
**17 WTS005** 5%



**WILDCAT  
BLACK MASSAGE  
STEERING WHEEL COVER**

Drive in style with steering wheel cover which will not only provide unmatched comfort while driving but will also save you from sudden steering slips which usually happens in hot or wet weather conditions.

- Features a rigid shape for improved grip.
- Simple installation - just slips on.
- Fits: most 360mm to 390mm wheel diameters.

PRODUCT CODE  
**49 103960**



**WILDCAT  
LEATHER LOOK  
STEERING WHEEL COVER**

The elegant design of this steering wheel cover enhances the look and feel of your car's interior. Its rigid shape helps to improve your grip on the wheel.

- Features a rigid shape for improved grip.
- Simple installation - just slips on.
- Fits: most 360mm to 390mm wheel diameters.

PRODUCT CODE  
**49 111614**



**ALL BLACKS  
STEERING WHEEL COVER**

Keep the All Blacks support going in your car with the All Blacks Steering Wheel Cover.

- All Blacks name and logo.
- Fits most vehicles with 360 to 390mm Steering Wheels.
- No tools or laces required.

PRODUCT CODE  
**49 ABSW550**



**R.M. WILLIAMS  
BLACK LEATHER  
STEERING WHEEL COVER WHITE TRIM**

R.M. Williams is known for their quality leather boots. Now you can get a R.M. Williams steering wheel cover made from the same high-quality leather. The steering wheel cover designed to suit most steering wheels.

- Genuine leather.
- Fits most vehicles.
- Easy to install.
- Protects from wear and tear.
- Diameter: 38cm.

PRODUCT CODE  
**49 SWRMWBLK**



**CATERPILLAR  
BLACK LEATHER  
STEERING WHEEL COVER**

Whether your steering wheel is showing signs of wear or you want to freshen it up, this is the product for you! Easily installed with a universal design it fits most steering wheels.

- Official CAT licenced merchandise.
- Genuine leather.
- Printed CAT logo.
- Universal 15in size.
- Fits most steering wheels.

PRODUCT CODE  
**49 SWCATBLK**



**WILDCAT  
MESH SEAT BELT PAD  
BLACK**

Instantly customize your car, truck, van or SUV with this brand new shoulder belt seat pad. Shoulder pad has various uses besides seat belts that include luggage, golf bags, duffle bags, hand bags, backpacks and much more.

- Stylish mesh cushioned pad.
- Slips easily onto the seat belt.
- Prevents rubbing.
- Can also be used on luggage straps.

PRODUCT CODE  
**49 117151**



**WILDCAT  
MESH SEAT BELT PAD  
GREY**

Instantly customize your car, truck, van or SUV with this brand new shoulder belt seat pad. Shoulder pad has various uses besides seat belts that include luggage, golf bags, duffle bags, backpacks and much more.

- Stylish mesh cushioned pad.
- Slips easily onto the seat belt.
- Prevents rubbing.
- Can also be used on luggage straps.

PRODUCT CODE  
**49 117161**



**ALL BLACKS  
SEAT BELT PAD**

Show your support for the New Zealand All Blacks with this seat belt pad. The seat belt pad is comfortable and has the All Blacks logo on it.

- High quality foam backed fabric.
- Universal fit.
- Can also be used on bag shoulder straps.
- Sold individually.

PRODUCT CODE  
**49 ABBP190**



**WILDCAT  
SOFT SUEDE SEAT BELT PAD  
BLACK**

This comfortable seat belt shoulder pad is easy to use - simply wrap it around the seat belt. It can also be used on items such as luggage, backpacks, golf bags, or just about anything that has straps.

- Soft suede cushioned pad.
- Slips easily onto the seat belt.
- Prevents rubbing.
- Can also be used on luggage straps.

PRODUCT CODE  
**49 12325**



**WILDCAT  
SOFT SUEDE SEAT BELT PAD  
GREY**

The seat belt shoulder pad is made of a soft material, is grey in colour and is comfortable to use. You just need to wrap it around the seat belt strap.

- Soft suede cushioned pad.
- Slips easily onto the seat belt.
- Prevents rubbing.
- Can also be used on luggage straps.
- Colour: Grey.
- Adds comfort and cushion to seatbelt straps, luggage, backpacks, golf bags.

PRODUCT CODE  
**49 12326**



■ AUDI



**MAP**  
**AUDI 3-BUTTON REMOTE SHELL REPLACEMENT**

This shell is a replacement for your old or damaged remote.

- Make: Audi.
- Replacement shell.
- Buttons: 3.
- Suits: A4, A6 & Q7.

PRODUCT CODE  
**21 KF140**



**MAP**  
**AUDI 3-BUTTON REMOTE SHELL REPLACEMENT WITHOUT KEY**

This remote is the perfect complete replacement for a broken or worn out car key remote.

- Make: Audi.
- Buttons: 3.
- Description: Replacement shell.

PRODUCT CODE  
**21 KF141**

■ BMW



**MAP**  
**BMW VARIOUS MODELS 2-BUTTON REPLACEMENT FOR REMOTE**

This is a replacement button part to match the original in form and function. Best replacement for a key with broken buttons or worn key remote.

- Buttons: 2.
- Remote button replacement.
- Suits: Various BMW models.

PRODUCT CODE  
**21 KF312**



**MAP**  
**BMW VARIOUS MODELS 3-BUTTON REPLACEMENT FOR REMOTE**

Having trouble with your car remote or its buttons? Get a better option with this product.

- Make: BMW.
- Model: Various.
- Buttons: 3.
- Description: Remote button replacement.

PRODUCT CODE  
**21 KF313**



**MAP**  
**BMW VARIOUS MODELS 3-BUTTON COMPLETE REMOTE**

This remote is the perfect replacement for a broken or worn out car key remote.

- Buttons: 3.
- Make: BMW.
- Complete remote. Requires key cutting and specialty programming tools.

PRODUCT CODE  
**21 KF491**

**MAP**  
**KEYS & REMOTES**

**MAP**  
(Mechatronics Auto Parts) has an extensive range of replacement buttons, shells and complete remotes to suit many popular makes and models.

■ CHRYSLER



MAP  
**CHRYSLER VARIOUS MODELS 4-BUTTON REPLACEMENT FOR REMOTE**

Having trouble with your car remote or its buttons? Get a better option with this product.

- Make: Chrysler.
- Model: Various.
- Buttons: 4.
- Remote button replacement.

PRODUCT CODE  
**21 KF340**



MAP  
**CHRYSLER VARIOUS MODELS 4-BUTTON REPLACEMENT FOR REMOTE**

Having trouble with your car remote or its buttons? Get a better option with this product.

- Make: Chrysler.
- Model: Various.
- Buttons: 4.
- Remote button replacement.

PRODUCT CODE  
**21 KF343**



MAP  
**CHRYSLER VARIOUS MODELS 4-BUTTON REPLACEMENT FOR REMOTE**

This is a replacement button part to match the original in form and function. Best replacement for a key with broken buttons or worn key remote case. This tool is suitable for various Chrysler models.

- Buttons: 4.
- Remote button replacement.

PRODUCT CODE  
**21 KF345**



MAP  
**CHRYSLER/JEEP VARIOUS MODELS 2-BUTTON COMPLETE REMOTE**

This product is the best replacement for a worn or broken key. This is a complete remote, key case and buttons.

- Buttons: 2.
- Suits Chrysler: PT Cruiser & Sebring.
- Complete remote - requires key cutting and programming.

PRODUCT CODE  
**21 KF346**



MAP  
**CHRYSLER/JEEP VARIOUS MODELS 3-BUTTON COMPLETE REMOTE**

This product is the best replacement for a worn or broken key. This is a complete remote, key case and buttons.

- Buttons: 3.
- Suits: Chrysler 300C.
- Complete remote - requires key cutting and programming.

PRODUCT CODE  
**21 KF347**



MAP  
**CHRYSLER/JEEP 2-BUTTON REMOTE SHELL REPLACEMENT**

Replacement shell - no electronics. Requires key cutting.

- Make: Chrysler, Dodge, Jeep.
- Replacement shell.
- Buttons: 2.
- Model: Suits all keyless vehicles 2012 ON.

PRODUCT CODE  
**21 KF348**

■ FORD



MAP  
**FORD EF-EL AU1 2-BUTTON REPLACEMENT FOR REMOTE**

Having trouble with your car remote or its buttons? Get a better option with this product.

- Make: Ford.
- Model: Falcon EF - EL & AU 1.
- Buttons: 2.
- Remote button replacement.

PRODUCT CODE  
**21 KF102**



MAP  
**FORD AU2/AU3 3-BUTTON REPLACEMENT FOR REMOTE**

This is a replacement button part to match the original in form and function. Best replacement for a key with broken buttons or worn key remote case.

- Buttons: 3.
- Remote button replacement.
- Suits: Ford Falcon AU 2 & 3.

PRODUCT CODE  
**21 KF103**



MAP  
**FORD AU2/AU3 4-BUTTON REPLACEMENT FOR REMOTE**

This is a replacement button part to match the original in form and function. Best replacement for a key with broken buttons or worn key remote case.

- Buttons: 4.
- Remote button replacement.
- Suits: Ford Falcon AU 2 & 3.

PRODUCT CODE  
**21 KF104**



MAP  
**FORD AU2/AU3 4-BUTTON COMPLETE REMOTE**

This car remote is a complete unit including all internals/ battery and it is ready to be programmed and used.

- Make: Ford.
- Model: Falcon AU 2 & 3.
- Buttons: 2 and 3.
- Complete remote including electronics - requires programming.

PRODUCT CODE  
**21 KF105**



MAP  
**FORD MAZDA 3-BUTTON REPLACEMENT FOR REMOTE**

Having trouble with your car remote or its buttons? Get a better option with this product.

- Make: Ford/Mazda.
- Model: Escape/Tribute.
- Buttons: 2 and 3.
- Remote button replacement.

PRODUCT CODE  
**21 KF107**



MAP  
**FORD MAZDA 2-BUTTON COMPLETE REMOTE & FLIP KEY**

This car remote is the complete replacement for your existing car remote. This tool is a complete remote & key including electronics which will require programming and key cutting.

- Buttons: 2.
- Complete remote including electronics - requires programming.
- Suits: Ford Escape and a Mazda 2.

PRODUCT CODE  
**21 KF108**



MAP  
**FORD MAZDA 4-BUTTON REPLACEMENT FOR REMOTE**

Having trouble with your car remote or its buttons? Get a better option with this product.

- Make: Ford.
- Model: Escape - various models.
- Buttons: 4.
- Remote button replacement.

PRODUCT CODE  
**21 KF109**



MAP  
**FORD BA-BF 3-BUTTON REPLACEMENT FOR REMOTE**

This is a replacement button part to match the original in form and function. Best replacement for a key with broken buttons or worn key remote case.

- Buttons: 3.
- Remote button replacement.

PRODUCT CODE  
**21 KF113**



■ FORD (CONTINUED)



**MAP**  
**FORD BA-BF 4-BUTTON**  
**REPLACEMENT**  
**FOR REMOTE**

This is a replacement part to match the original in form and function. Best replacement for a key with broken buttons or worn key remote case.

- Buttons: 4.
- Remote button replacement.
- Suits: Ford Falcon BA - BF.

PRODUCT CODE  
**21 KF114**



**MAP**  
**FORD BA-BF 3-BUTTON**  
**REMOTE SHELL**  
**REPLACEMENT**

This is a replacement part to match the original in form and function. Best replacement for a key with broken buttons, worn key remote case or a broken remote shell.

- Buttons: 3.
- Remote button & shell replacement.
- Suits: Ford Falcon BA - BF.

PRODUCT CODE  
**21 KF133**



**MAP**  
**FORD BA-BF 4-BUTTON**  
**REMOTE SHELL**  
**REPLACEMENT**

This is a replacement part to match the original in form and function. Best replacement for a key with broken buttons, worn key remote case or a broken remote shell.

- Buttons: 4.
- Remote button & shell replacement.
- Suits: Ford Falcon BA - BF.

PRODUCT CODE  
**21 KF134**



**MAP**  
**FORD BA-BF 4-BUTTON**  
**COMPLETE REMOTE**

This product is the best replacement for a worn or broken key. This is a complete remote, key case and buttons, includes electronic internals and battery.

- Make: Ford.
- Model: Falcon BA - BF.
- Buttons: 4.
- Complete remote including electronics - requires programming.

PRODUCT CODE  
**21 KF135**



**MAP**  
**FORD/MAZDA 2-BUTTON**  
**COMPLETE REMOTE**  
**& FLIP KEY**

This remote is the perfect complete replacement for a broken or worn out car key remote.

- Make: Ford/Mazda.
- Complete remote.
- Buttons: 2.
- Suits: BT-50 & Ranger.

PRODUCT CODE  
**21 KF162**



**MAP**  
**FORD MONDEO TRANSIT**  
**3-BUTTON REMOTE SHELL**  
**& KEY REPLACEMENT**

This shell is the ideal complete remote shell replacement.

- Make: Ford/Mazda.
- Remote shell.
- Buttons: 3.
- Suits: Focus, Mondeo & Transit.

PRODUCT CODE  
**21 KF163**



**MAP**  
**FORD VARIOUS MODELS**  
**3-BUTTON REMOTE SHELL**  
**& KEY REPLACEMENT**

This shell is a replacement for your old or damaged remote.

- Make: Ford.
- Replacement shell.
- Buttons: 3.
- Suits: Fiesta, Focus, Kuga & Mondeo.

PRODUCT CODE  
**21 KF165**



**MAP**  
**FORD KUGA 3-BUTTON**  
**REMOTE SHELL**  
**& KEY REPLACEMENT**

This shell is a replacement for your old or damaged remote.

- Make: Ford.
- Replacement shell.
- Buttons: 3.

PRODUCT CODE  
**21 KF167**



**MAP**  
**FORD BA-BF 3-BUTTON**  
**COMPLETE REMOTE**

This product is the best replacement for a worn or broken key. This is a complete remote, key case and buttons, includes electronic internals and battery.

- Make: Ford.
- Model: Falcon BA - BF.
- Buttons: 3.
- Complete remote including electronics - requires programming.

PRODUCT CODE  
**21 KF136**



**MAP**  
**FORD VARIOUS MODELS**  
**3-BUTTON COMPLETE**  
**REMOTE & FLIP KEY**

Ford Falcon BF - FG and Ford Territory. It is a complete 3 button remote & flip key including electronics - requires programming & key cutting.

PRODUCT CODE  
**21 KF150**



**MAP**  
**FORD FOCUS MONDEO**  
**3-BUTTON COMPLETE**  
**REMOTE & FLIP KEY**

This remote is the perfect complete replacement for a broken or worn out car key remote.

- Make: Ford.
- Complete remote.
- Buttons: 3.
- Suits: base models Focus, Mondeo & Transit 2010 ON.

PRODUCT CODE  
**21 KF160**



**MAP**  
**FORD/MAZDA 2-BUTTON**  
**REMOTE SHELL**  
**& KEY REPLACEMENT**

This remote is the perfect shell & key replacement for a broken or worn out car key remote.

- Buttons: 2.
- Make: Ford/Mazda.
- Shell & key replacement..

PRODUCT CODE  
**21 KF161**



**MAP**  
**FORD RANGER PX**  
**2-BUTTON REMOTE SHELL**  
**& KEY REPLACEMENT**

Shell & key replacement.

- Make: Ford.
- Model: Ranger PX (Series 2 & 3).
- Buttons: 2.

PRODUCT CODE  
**21 KF168**



**MAP**  
**FORD MONDEO MUSTANG**  
**3-BUTTON REMOTE SHELL**  
**& KEY REPLACEMENT**

Shell & key replacement.

- Make: Ford.
- Model: Everest, Mondeo & Mustang.
- Buttons: 3.

PRODUCT CODE  
**21 KF169**



**MAP**  
**FORD/MAZDA VARIOUS**  
**MODELS 2-BUTTON**  
**& REMOTE SHELL**  
**REPLACEMENT**

This remote is the perfect shell & buttons replacement for a broken or worn out car key remote.

- Make: Ford/Mazda.
- Remote button.
- Buttons: 2.
- Model: Suits Laser '98-'02, 323 '98-'03, 626 '98-'02, Mazda 2 '02-'07, Mazda 3 BK Series 1 & Mazda 6 GG Series 1.

PRODUCT CODE  
**21 KF249**

■ HOLDEN



**MAP HOLDEN COMMODORE VS-VZ KEY REMOTE DIY PROGRAMMING TOOL**

Eliminate a costly trip to the dealer with this keyless entry remote programmer. It allows you to easily sync a new remote to your vehicle in less than five minutes. The keyless entry remotes are a user-friendly programming tool.

- Make: Holden.
- Model: Commodore VS - VZ.
- Key remote DIY programming tool suitable for use with products 'KF204' & 'KF205'.

PRODUCT CODE  
**21 KF200**



**MAP HOLDEN VS-VZ 3-BUTTON COMPLETE REMOTE & KEY**

This car remote is the complete replacement for your existing car remote. This tool is a complete remote & key including electronics which will require programming and key cutting.

- Buttons: 3.
- Description: Complete remote & key including electronics - requires programming & key cutting.
- Suits: Holden Commodore VS - VZ.

PRODUCT CODE  
**21 KF204**



**MAP HOLDEN VR 1-BUTTON & REMOTE SHELL REPLACEMENT**

This product is a replacement shell and button pad for your car remote. Perfect for repairing or renewing your existing remote. This tool is suitable for a Holden Commodore VS - VZ.

- Buttons: 1.
- Description: Remote button & shell replacement.

PRODUCT CODE  
**21 KF201**



**MAP HOLDEN VS-VZ 2-BUTTON & REMOTE SHELL REPLACEMENT**

This product is a replacement shell and button pad for your car remote. Perfect for repairing or renewing your existing remote. This tool is suitable for a Holden Commodore VS - VZ.

- Buttons: 2.
- Description: Remote button & shell replacement.

PRODUCT CODE  
**21 KF202**



**MAP HOLDEN VS-VZ 3-BUTTON & REMOTE SHELL REPLACEMENT**

This product is a replacement shell and button pad for your car remote. Perfect for repairing or renewing your existing remote. This tool is suitable for a Holden Commodore VS - VZ.

- Buttons: 3.
- Description: Remote button & shell replacement.

PRODUCT CODE  
**21 KF203**



**MAP HOLDEN VS-VZ 2-BUTTON COMPLETE REMOTE & KEY**

This car remote is the complete replacement for your existing car remote. This tool is a complete remote & key including electronics which will require programming and key cutting.

- Buttons: 2.
- Complete remote & key including electronics - requires programming & key cutting.
- Suits: Holden Commodore VS - VZ.

PRODUCT CODE  
**21 KF205**



**MAP HOLDEN VE 2-BUTTON REPLACEMENT FOR REMOTE**

This product is a replacement shell and button pad for your car remote. Perfect for repairing or renewing your existing remote. This tool is suitable for a Holden Commodore VE.

- Buttons: 2.
- Remote button replacement.

PRODUCT CODE  
**21 KF212**



**MAP HOLDEN VE 3-BUTTON REPLACEMENT FOR REMOTE**

This is a replacement button part to match the original in form and function. Best replacement for a key with broken buttons or worn key remote case.

- Buttons: 3.
- Remote button replacement.
- Suits: Holden Commodore VE.

PRODUCT CODE  
**21 KF213**



**MAP HOLDEN VE 2-BUTTON & REMOTE SHELL REPLACEMENT**

This is a replacement part to match the original in form and function. Best replacement for a key with broken buttons, worn key remote case or a broken remote shell.

- Buttons: 2.
- Remote button & shell replacement - Requires key cutting (no electronics).
- Suits: Holden Commodore VE.

PRODUCT CODE  
**21 KF214**



**MAP HOLDEN VE 3-BUTTON & REMOTE SHELL REPLACEMENT**

This product is the best replacement for a worn or broken key. This is a complete remote, key case and buttons.

- Make: Holden.
- Model: Commodore VE.
- Buttons: 3.
- Remote button & shell replacement - Requires key cutting (no electronics).

PRODUCT CODE  
**21 KF215**



**MAP HOLDEN VE 2-BUTTON COMPLETE REMOTE & FLIP KEY**

A complete 2 button flip key that requires key cutting & programming.

PRODUCT CODE  
**21 KF216**



**MAP HOLDEN VE 3-BUTTON COMPLETE REMOTE & FLIP KEY**

This is a replacement part to match the original in form and function. Best replacement for a key with broken buttons, worn key remote case or a broken remote shell.

- Buttons: 3.
- Remote button & shell replacement.
- Suits: Holden Commodore VE.

PRODUCT CODE  
**21 KF217**



**MAP HOLDEN VF 5-BUTTON REMOTE SHELL & KEY REPLACEMENT**

This is a replacement part to match the original in form and function. Best replacement for a key with broken buttons, worn key remote case or a broken remote shell.

- Buttons: 5.
- Remote shell & key replacement - Requires key cutting (no electronics).
- Suits: Holden Commodore VF.

PRODUCT CODE  
**21 KF218**



**MAP HOLDEN VF 5-BUTTON COMPLETE REMOTE**

This car remote is the complete replacement for your existing car remote. This tool is a complete remote & key including electronics which will require programming and key cutting.

- Buttons: 5.
- Complete 5 button flip key - Requires key cutting & programming.
- Suits: Holden Commodore VF.

PRODUCT CODE  
**21 KF219**



**MAP HOLDEN VF 4-BUTTON REMOTE SHELL & KEY REPLACEMENT**

This is a replacement part to match the original in form and function. Best replacement for a key with broken buttons, worn key remote case or a broken remote shell.

- Buttons: 4.
- Remote shell & key replacement - Requires key cutting (no electronics).
- Suits: Holden Commodore VF.

PRODUCT CODE  
**21 KF220**



**MAP HOLDEN VF 4-BUTTON COMPLETE REMOTE**

This car remote is the complete replacement for your existing car remote. This tool is a complete remote & key including electronics which will require programming and key cutting.

- Buttons: 4.
- Complete 4 button flip key - Requires key cutting & programming.
- Suits: Holden Commodore VF.

PRODUCT CODE  
**21 KF221**

■ HOLDEN (CONTINUED)



**MAP**  
**HOLDEN ASTRA BARINA**  
**2-BUTTON REPLACEMENT**  
**FOR REMOTE**

This is a replacement button part to match the original in form and function. Best replacement for a key with broken buttons or worn key remote case.

- Buttons: 2.
- Remote button replacement.
- Suits: Holden Astra.

PRODUCT CODE  
**21 KF222**



**MAP**  
**HOLDEN ASTRA 2-BUTTON**  
**COMPLETE REMOTE**

This car remote is the complete replacement for your existing car remote. This tool is a complete remote & key including electronics which will require programming and key cutting.

- Buttons: 2.
- Complete 2 button flip key - Requires key cutting & programming.
- Suits: Holden Astra.

PRODUCT CODE  
**21 KF224**



**MAP**  
**HOLDEN CAPTIVA**  
**3-BUTTON REMOTE SHELL**  
**& KEY REPLACEMENT**

This remote is the perfect shell replacement for a broken or worn out car key remote.

- Buttons: 3.
- Make: Holden.
- Remote shell & key replacement - Requires key cutting (no electronics).

PRODUCT CODE  
**21 KF225**



**MAP**  
**HOLDEN CAPTIVA CG**  
**3-BUTTON COMPLETE**  
**REMOTE**

This car remote is the complete replacement for your existing car remote. This tool is a complete remote & key including electronics which will require programming and key cutting.

- Buttons: 3.
- Complete remote flip key.
- Suits: Holden Captiva CG (series 1).

PRODUCT CODE  
**21 KF226**



**MAP**  
**HOLDEN CRUZE BARINA**  
**3-BUTTON COMPLETE**  
**REMOTE**

This car remote is the complete replacement for your existing car remote. This tool is a complete remote & key including electronics which will require programming and key cutting.

- Buttons: 3.
- Complete 3 button flip key - Requires key cutting & programming.
- Suits: Holden Cruze.

PRODUCT CODE  
**21 KF241**



**MAP**  
**HOLDEN CRUZE**  
**COLORADO 2-BUTTON**  
**REMOTE SHELL**  
**& KEY REPLACEMENT**

This is a replacement part to match the original in form and function. Best replacement for a key with broken buttons, worn key remote case or a broken remote shell.

- Buttons: 2.
- Remote shell & key replacement - Requires key cutting (no electronics).
- Suits: Holden Cruze.

PRODUCT CODE  
**21 KF242**



**MAP**  
**HOLDEN CRUZE**  
**COLORADO 2-BUTTON**  
**COMPLETE REMOTE**

This remote is the perfect shell & key replacement for a broken or worn out car key remote.

- Buttons: 2.
- Make: Holden.
- Complete remote replacement - Requires key cutting and programming with scan tool.

PRODUCT CODE  
**21 KF243**



**MAP**  
**HOLDEN CAPTIVA**  
**3-BUTTON REMOTE SHELL**  
**REPLACEMENT**

This remote is the perfect shell & key replacement for a broken or worn out car key remote.

- Buttons: 3.
- Make: Holden.
- Replacement shell - requires key cutting.

PRODUCT CODE  
**21 KF227**



**MAP**  
**HOLDEN ASTRA 2-BUTTON**  
**REPLACEMENT FOR**  
**REMOTE**

This is a replacement button part to match the original in form and function. Best replacement for a key with broken buttons or worn key remote case.

- Buttons: 2.
- Remote button replacement.
- Suits: Holden Astra.

PRODUCT CODE  
**21 KF232**



**MAP**  
**HOLDEN ASTRA 3-BUTTON**  
**REPLACEMENT FOR**  
**REMOTE**

This is a replacement button part to match the original in form and function. Best replacement for a key with broken buttons or worn key remote case.

- Buttons: 3.
- Remote button replacement.
- Suits: Holden Astra.

PRODUCT CODE  
**21 KF233**



**MAP**  
**HOLDEN CRUZE BARINA**  
**3-BUTTON REMOTE SHELL**  
**& KEY REPLACEMENT**

This product is the best replacement for a worn or broken key. This is a complete remote, key case and buttons.

- Make: Holden.
- Model: Cruze / Barina.
- Buttons: 3.
- Shell & key replacement only.

PRODUCT CODE  
**21 KF240**



**MAP**  
**HOLDEN ASTRA 3-BUTTON**  
**& REMOTE SHELL**  
**REPLACEMENT**

This product is the best replacement for a worn or broken key. This is a complete remote, key case and buttons.

- Make: Holden.
- Model: Astra.
- Buttons: 3.
- Remote shell & button replacement.

PRODUCT CODE  
**21 KF245**



**MAP**  
**HOLDEN COLORADO/**  
**RODEO 2-BUTTON REMOTE**  
**SHELL & KEY REPLACEMENT**

This product is the best replacement for a worn or broken key. This is a complete remote, key case and buttons.

- Make: Holden.
- Model: Colorado/Rodeo.
- Buttons: 2.
- Shell & key replacement only.

PRODUCT CODE  
**21 KF350**

■ HONDA



**MAP**  
**HONDA VARIOUS MODELS 3-BUTTON REMOTE SHELL & KEY REPLACEMENT**

Replace your old or broken Honda remote shell cover with this new key shell. Have it cut to match your original remote key at your local auto locksmith.

- Make: Honda.
- Model: Various models 2 button & shell.
- Buttons: 3.
- Shell & key 3 button replacement.

PRODUCT CODE  
**21 KF360**

**MAP**  
**HONDA VARIOUS MODELS 2-BUTTON REMOTE SHELL & KEY REPLACEMENT**

This product is the best replacement for a worn or broken key. This is a complete remote, key case and buttons.

- Make: Honda.
- Model: Various.
- Buttons: 2.
- Shell & key replacement only.

PRODUCT CODE  
**21 KF361**

**MAP**  
**HONDA ACCORD/CIVIC 2-BUTTON COMPLETE REMOTE**

This is a replacement part to match the original in form and function. Best replacement for a key with broken buttons or worn key remote case. This case is suited for a Honda Accord and Civic.

- Buttons: 2.
- Remote button replacement.

PRODUCT CODE  
**21 KF362**

**MAP**  
**HONDA VARIOUS MODELS 3-BUTTON COMPLETE REMOTE**

This car remote is the replacement for your existing car remote. This tool is a complete remote & key including electronics which will require programming and key cutting. This tool is suitable for various Honda models.

- Buttons: 3.
- Complete remote & key including electronics - requires programming & key cutting.

PRODUCT CODE  
**21 KF363**



**MAP**  
**HONDA VARIOUS MODELS 3-BUTTON REMOTE SHELL REPLACEMENT**

This remote is the perfect shell replacement for a broken or worn out car key remote.

- Buttons: 3.
- Make: Honda.
- Honda 3 button shell with transponder slot. Buttons not included. Requires key cutting.

PRODUCT CODE  
**21 KF364**

**MAP**  
**HONDA JAZZ/INSIGHT 2-BUTTON REMOTE SHELL REPLACEMENT**

Shell & key replacement.

- Make: Honda.
- Shell and key replacement.
- Buttons: 2.
- Model: Suits Insight and Jazz.

PRODUCT CODE  
**21 KF365**

**MAP**  
**HONDA VARIOUS MODELS 2-BUTTON REMOTE SHELL REPLACEMENT**

This remote is the perfect shell replacement for a broken or worn out car key remote.

- Buttons: 2.
- Make: Honda.
- Replacement shell.

PRODUCT CODE  
**21 KF366**

**MAP**  
**HONDA VARIOUS MODELS 3-BUTTON REMOTE SHELL REPLACEMENT**

This remote is the perfect shell replacement for a broken or worn out car key remote.

- Buttons: 3.
- Make: Honda.
- Replacement shell.

PRODUCT CODE  
**21 KF367**

■ HYUNDAI



**MAP**  
**HYUNDAI VARIOUS MODELS 2-BUTTON COMPLETE REMOTE**

This remote is the perfect replacement for a broken or worn out car key remote.

- Buttons: 2.
- Make: Hyundai.
- Complete remote - requires programming with scan tool.

PRODUCT CODE  
**21 KF273**

**MAP**  
**HYUNDAI VARIOUS MODELS 3-BUTTON REMOTE SHELL REPLACEMENT**

This remote is the perfect shell replacement for a broken or worn out car key remote.

- Buttons: 3.
- Make: Hyundai.
- Replacement shell - no electronics. Requires key cutting.

PRODUCT CODE  
**21 KF274**

**MAP**  
**HYUNDAI VARIOUS MODELS 2-BUTTON REMOTE SHELL REPLACEMENT**

This remote is the perfect shell replacement for a broken or worn out car key remote.

- Buttons: 2.
- Make: Hyundai.
- Shell replacement.

PRODUCT CODE  
**21 KF276**

**MAP**  
**HYUNDAI VARIOUS MODELS 3-BUTTON REMOTE SHELL & KEY REPLACEMENT**

This is a replacement part to match the original in form and function. Best replacement for a key with broken buttons, worn key remote case or a broken remote shell. This case is suited for Hyundai and Kia vehicles.

- Buttons: 3.
- Remote button & shell replacement.

PRODUCT CODE  
**21 KF330**



**MAP**  
**HYUNDAI VARIOUS MODELS 3-BUTTON REMOTE SHELL REPLACEMENT**

This remote is the perfect shell replacement for a broken or worn out car key remote.

- Buttons: 3.
- Make: Hyundai.
- Shell replacement - no electronics.

PRODUCT CODE  
**21 KF334**

**MAP**  
**HYUNDAI VARIOUS MODELS 2-BUTTON REMOTE SHELL REPLACEMENT FOR REMOTE**

Having trouble with your car remote or its buttons? Get a better option with this product.

- Make: Hyundai.
- Model: Various.
- Buttons: 2.
- Remote button replacement.

PRODUCT CODE  
**21 KF335**

**MAP**  
**HYUNDAI VARIOUS MODELS 2-BUTTON REMOTE SHELL REPLACEMENT FOR REMOTE**

This is a replacement button part to match the original in form and function. Best replacement for a key with broken buttons or worn key remote case. This tool is suitable for various Hyundai models.

- Buttons: 2.
- Remote button replacement.

PRODUCT CODE  
**21 KF336**

**MAP**  
**HYUNDAI VARIOUS MODELS 3-BUTTON REMOTE SHELL REPLACEMENT FOR REMOTE**

This is a replacement button part to match the original in form and function. Best replacement for a key with broken buttons or worn key remote case. This tool is suitable for various Hyundai models.

- Buttons: 3.
- Remote button replacement.

PRODUCT CODE  
**21 KF337**

■ HYUNDAI (CONTINUED)



MAP  
HYUNDAI VARIOUS MODELS 1-BUTTON REPLACEMENT FOR REMOTE

Having trouble with your car remote or its buttons? Get a better option with this product.

- Make: Hyundai.
- Model: Various.
- Buttons: 1.
- Remote button replacement.

PRODUCT CODE  
**21 KF338**



MAP  
HYUNDAI GRANDEUR 3-BUTTON REPLACEMENT FOR REMOTE

This is a replacement button part to match the original in form and function. Best replacement for a key with broken buttons or worn key remote case. This tool is suitable for various Hyundai models.

- Buttons: 3.
- Remote button replacement.

PRODUCT CODE  
**21 KF339**



MAP  
HYUNDAI VARIOUS MODELS 3-BUTTON COMPLETE REMOTE & FLIP KEY

This car remote is the complete replacement for your existing car remote. This tool is a complete remote & key including electronics which will require programming and key cutting. This tool is suitable for various Kia and Hyundai models.

- Buttons: 3.
- Description: Complete remote 3 button flip key.

PRODUCT CODE  
**21 KF371**



MAP  
HYUNDAI VARIOUS MODELS 1-BUTTON REMOTE SHELL & KEY REPLACEMENT

This is a replacement part to match the original in form and function. Best replacement for a key with broken buttons, worn key remote case or a broken remote shell. This case is suited for Hyundai and Kia models.

- Buttons: 1.
- Description: Shell & key replacement .

PRODUCT CODE  
**21 KF379**



MAP  
HYUNDAI VARIOUS MODELS 3-BUTTON REMOTE SHELL & KEY REPLACEMENT

This shell is a replacement for your old or damaged remote.

- Make: Hyundai.
- Buttons: 3.
- Remote shell replacement.

PRODUCT CODE  
**21 KF440**

■ JEEP



MAP  
JEEP VARIOUS MODELS 3-BUTTON REPLACEMENT FOR REMOTE

This is a replacement button part to match the original in form and function. Best replacement for a key with broken buttons or worn key remote case. This tool is suitable for various Jeep models.

- Buttons: 3.
- Remote button replacement.

PRODUCT CODE  
**21 KF344**

■ KIA



MAP  
KIA CARNIVAL 3-BUTTON REMOTE SHELL REPLACEMENT

This remote is the perfect shell & buttons replacement for a broken or worn out car key remote.

- Buttons: 3.
- Make: Kia.
- Replacement shell.

PRODUCT CODE  
**21 KF270**



MAP  
KIA CARNIVAL 4-BUTTON REMOTE SHELL REPLACEMENT

This remote is the perfect shell & buttons replacement for a broken or worn out car key remote.

- Buttons: 4.
- Make: Kia.
- Replacement shell.

PRODUCT CODE  
**21 KF271**

■ LAND ROVER



MAP  
LAND ROVER VARIOUS MODELS 3-BUTTON REMOTE SHELL REPLACEMENT

This remote is the perfect shell replacement for a broken or worn out car key remote.

- Buttons: 3.
- Make: Landrover.
- Shell replacement.
- Requires key cutting.

PRODUCT CODE  
**21 KF480**



MAP  
LAND ROVER VARIOUS MODELS 5-BUTTON REMOTE SHELL REPLACEMENT

This remote is the perfect replacement for a broken or worn out car key remote.

- Make: Landrover.
- Model: Discovery 3 & Range Rover L322.
- Buttons: 5.
- Shell replacement.

PRODUCT CODE  
**21 KF481**

■ LEXUS



MAP  
LEXUS VARIOUS MODELS 3-BUTTON REMOTE SHELL REPLACEMENT

This remote is the perfect shell replacement for a broken or worn out car key remote.

- Buttons: 3.
- Make: Lexus.
- Shell replacement.
- Requires key cutting.

PRODUCT CODE  
**21 KF460**



MAP  
LEXUS VARIOUS MODELS 4-BUTTON REMOTE SHELL REPLACEMENT

This remote is the perfect shell replacement for a broken or worn out car key remote.

- Make: Lexus.
- Buttons: 4.
- Remote shell replacement.

PRODUCT CODE  
**21 KF461**

MAZDA



**MAP**  
**MAZDA 2, 3 & BT50**  
**2-BUTTON & REMOTE**  
**SHELL REPLACEMENT**

This product is the best replacement for a worn or broken key. This is a complete remote, key case and buttons.

- Make: Mazda.
- Model: Various.
- Buttons: 2.
- Remote button & shell replacement.

PRODUCT CODE  
**21 KF250**



**MAP**  
**MAZDA 3 & 6 - 3-BUTTON**  
**& REMOTE SHELL**  
**REPLACEMENT**

This is a replacement button part to match the original in form and function. Best replacement for a key with broken buttons or worn key remote case.

- Buttons: 3.
- Remote button & shell replacement.
- Suits: Mazda 3 and Mazda 6.

PRODUCT CODE  
**21 KF251**



**MAP**  
**MAZDA VARIOUS MODELS**  
**2-BUTTON & HALF SHELL**  
**REMOTE REPLACEMENT**

This is a new replacement outer shell/case to replace your worn or broken remote's case shell. You can easily move the internal components from your old remote to this new replacement shell.

- Make: Mazda.
- Suits: Mazda CX7 / CX9 and Mazda 2 / 6.
- Buttons: 2.
- Half shell. No electronics or flip key.

PRODUCT CODE  
**21 KF252**



**MAP**  
**MAZDA 3 & 6 - 3-BUTTON**  
**& HALF SHELL REMOTE**  
**REPLACEMENT**

This is a replacement button part to match the original in form and function. Best replacement for a key with broken buttons or worn key remote case.

- Buttons: 3.
- Half shell. No electronics or flip key.
- Suits: Mazda 6.

PRODUCT CODE  
**21 KF253**



**MAP**  
**MAZDA 2, 3 & BT50**  
**2-BUTTON REMOTE ONLY**  
**WITHOUT KEY**

This product is the best replacement for a worn or broken key remote. This is a complete remote with buttons.

- Buttons: 2.
- Suits Mazda: BT50, Mazda 2 & Mazda 3.
- Remote only.

PRODUCT CODE  
**21 KF254**



**MAP**  
**MAZDA VARIOUS MODELS**  
**2-BUTTON REMOTE ONLY**  
**WITHOUT KEY**

This product is the best replacement for a worn or broken key remote. This is a complete remote with buttons.

- Buttons: 2.
- Suits Mazda: CX7/CX9, Mazda 2 & Mazda 3.
- Remote only.

PRODUCT CODE  
**21 KF256**



**MAP**  
**MAZDA 3 & 6 3-BUTTON**  
**REMOTE ONLY WITHOUT**  
**KEY**

This product is the best replacement for a worn or broken key remote. This is a complete remote with buttons.

- Buttons: 3.
- Suits Mazda: Mazda 3 sedan & Mazda 6.
- Remote only.

PRODUCT CODE  
**21 KF257**



**MAP**  
**MAZDA VARIOUS MODELS**  
**BLANK KEY**

This product is a key blank for Mazda and does not include the remote.

- Buttons: 0.
- Suits: Mazda 3 sedan and Mazda 6.
- Key blank only.

PRODUCT CODE  
**21 KF259**



**MAP**  
**MAZDA 2 3 & BT50**  
**2-BUTTON COMPLETE**  
**REMOTE & KEY**

This remote is the perfect replacement for a broken or worn out car key remote.

- Make: Mazda.
- Complete remote.
- Buttons: 2.
- Model: Suits BT50, Mazda 2, Mazda 3.

PRODUCT CODE  
**21 KF264**



**MAP**  
**MAZDA VARIOUS MODELS**  
**2-BUTTON COMPLETE**  
**REMOTE & KEY**

This remote is the perfect replacement for a broken or worn out car key remote.

- Make: Mazda.
- Complete remote.
- Buttons: 2.
- Model: Mazda CX7/CX9, Mazda 2, Mazda 3 hatch.

PRODUCT CODE  
**21 KF266**



**MAP**  
**MAZDA 3 & 6 3-BUTTON**  
**COMPLETE REMOTE & KEY**

This remote is the perfect complete replacement for a broken or worn out car key remote.

- Make: Mazda.
- Complete remote.
- Buttons: 3.
- Model: Mazda 3 sedan & Mazda 6.

PRODUCT CODE  
**21 KF267**



**MAP**  
**MAZDA VARIOUS MODELS**  
**2-BUTTON REMOTE SHELL**  
**REPLACEMENT**

This shell is a replacement for your old or damaged remote.

- Make: Mazda.
- Replacement shell.
- Buttons: 2.
- Model: CX-3, CX-5, CX-9, Mazda 2, Mazda 3, Mazda 6.

PRODUCT CODE  
**21 KF268**

MERCEDES



**MAP**  
**MAZDA 3 3-BUTTON**  
**REMOTE SHELL**  
**REPLACEMENT**

This product is a replacement shell and button pad for your car remote. Perfect for repairing or renewing your existing remote. This tool is suitable for the Mazda 3 sedan.

- Buttons: 3.
- Description: Replacement shell.

PRODUCT CODE  
**21 KF269**



**MAP**  
**MERCEDES 3-BUTTON**  
**SMART REMOTE SHELL**  
**& KEY REPLACEMENT**

This product is a replacement shell and button pad for your car remote. Perfect for repairing or renewing your existing remote. This tool is suitable for various Mercedes models.

- Buttons: 3.
- Smart key shell & key replacement.

PRODUCT CODE  
**21 KF368**



**MAP**  
**MERCEDES 3-BUTTON**  
**SMART REMOTE SHELL**  
**REPLACEMENT**

This product is a replacement shell and button pad for your car remote. Perfect for repairing or renewing your existing remote. This tool is suitable for various Mercedes models.

- Buttons: 3.
- Smart key shell replacement (early).

PRODUCT CODE  
**21 KF369**



**MAP**  
**MERCEDES 3-BUTTON**  
**SMART REMOTE SHELL**  
**REPLACEMENT**

This product is a replacement shell and button pad for your car remote. Perfect for repairing or renewing your existing remote. This tool is suitable for various Mercedes models.

- Buttons: 3.
- Replacement shell & buttons.

PRODUCT CODE  
**21 KF370**

■ MITSUBISHI



**MAP**  
**MITSUBISHI VARIOUS MODELS 3-BUTTON REPLACEMENT FOR REMOTE**

Having trouble with your car remote or its buttons? Get a better option with this product.

- Make: Mitsubishi.
- Model: Various.
- Buttons: 3.
- Remote button replacement 2 and 3 buttons.

PRODUCT CODE  
**21 KF301**



**MAP**  
**MITSUBISHI VARIOUS MODELS 3-BUTTON REPLACEMENT FOR REMOTE**

Having trouble with your car remote or its buttons? Get a better option with this product.

- Make: Mitsubishi.
- Model: Various.
- Buttons: 3.
- Remote button replacement.

PRODUCT CODE  
**21 KF303**



**MAP**  
**MITSUBISHI VARIOUS MODELS 2-BUTTON REPLACEMENT FOR REMOTE**

Having trouble with your car remote or its buttons? Get a better option with this product.

- Make: Mitsubishi.
- Model: Various.
- Buttons: 2.
- Remote button replacement.

PRODUCT CODE  
**21 KF310**



**MAP**  
**MITSUBISHI VARIOUS MODELS 2-BUTTON REPLACEMENT FOR REMOTE**

Having trouble with your car remote or its buttons? Get a better option with this product.

- Make: Mitsubishi.
- Model: Various.
- Buttons: 2.
- Remote button replacement.

PRODUCT CODE  
**21 KF311**



**MAP**  
**MITSUBISHI CHALLENGER 3-BUTTON SHELL & KEY REPLACEMENT**

This is a replacement part to match the original in form and function. Best replacement for a key with broken buttons, worn key remote case or a broken remote shell. This case is suited for Mitsubishi vehicles.

- Make: Mitsubishi. Model: Lancer / Colt / ASX.
- Buttons: 3.
- Description: Shell & key replacement - left hand cut blade.

PRODUCT CODE  
**21 KF377**



**MAP**  
**MITSUBISHI VARIOUS MODELS 3-BUTTON SHELL & KEY REPLACEMENT**

A quick, easy and affordable way to replace a cracked or worn out keyless entry remote key case or shell. Installation is simple and reprogramming is not required. You must transfer over your original components into this case.

- Make: Mitsubishi.
- Model: Lancer / Colt / ASX.
- Buttons: 3.
- Shell & key replacement - right hand cut blade.
- New key blade must be cut to start the vehicle, please match the key blade style to the original blade.

PRODUCT CODE  
**21 KF378**



**MAP**  
**MITSUBISHI VARIOUS MODELS 3-BUTTON COMPLETE REMOTE**

This remote is a quick, easy and affordable way to replace your keyless entry remote control car key. Replacement keyless entry remote with battery and electronics installed.

- Make: Mitsubishi.
- Model: Magna TH-TW/Verada KH-KW.
- Buttons: 3.
- Complete remote.

PRODUCT CODE  
**21 KF386**



**MAP**  
**MITSUBISHI VARIOUS MODELS 2-BUTTON REMOTE SHELL REPLACEMENT**

This remote is the perfect shell replacement for a broken or worn out car key remote.

- Buttons: 2.
- Make: Mitsubishi.
- Replacement shell, no electronics needed.

PRODUCT CODE  
**21 KF430**



**MAP**  
**MITSUBISHI TRITON/ CHALLENGER 2-BUTTON COMPLETE REMOTE**

This car remote is the complete replacement for your existing car remote. This tool is a complete remote & key including electronics which will require programming and key cutting. This tool is suitable for a Mitsubishi Triton.

- Buttons: 2.
- Description: Complete Remote - Mitsubishi 2 button Triton. Left hand cut blade.

PRODUCT CODE  
**21 KF373**



**MAP**  
**MITSUBISHI VARIOUS MODELS 2-BUTTON COMPLETE REMOTE**

This is a complete remote and key including electronics which will require programming and key cutting. This tool is suitable for Mitsubishi Lancer/Colt/ ASX.

- Buttons: 2.
- Description: Complete remote - right hand cut blade.

PRODUCT CODE  
**21 KF374**



**MAP**  
**MITSUBISHI VARIOUS MODELS 2-BUTTON SHELL & KEY REPLACEMENT**

This is a replacement part to match the original in form and function. Best replacement for a key with broken buttons, worn key remote case or a broken remote shell.

- Make: Mitsubishi. Model: Lancer / Colt / ASX.
- Buttons: 2.
- Description: Shell & key replacement - left hand cut blade.

PRODUCT CODE  
**21 KF375**



**MAP**  
**MITSUBISHI VARIOUS MODELS 2-BUTTON SHELL & KEY REPLACEMENT**

This is a replacement part to match the original in form and function. Best replacement for a key with broken buttons, worn key remote case or a broken remote shell. This case is suited for Mitsubishi vehicles.

- Make: Mitsubishi. Model: Lancer / Colt / ASX.
- Buttons: 2.
- Description: Shell & key replacement - right hand cut blade.

PRODUCT CODE  
**21 KF376**



**MAP**  
**MITSUBISHI VARIOUS MODELS 2-BUTTON REMOTE SHELL REPLACEMENT**

This remote is the perfect replacement for a broken or worn out car key remote.

- Make: Mitsubishi.
- Replacement shell.
- Buttons: 2.
- Model: Suits ASX, Lancer sedan, Mirage & Outlander keyless start.

PRODUCT CODE  
**21 KF432**



**MAP**  
**MITSUBISHI VARIOUS MODELS 3-BUTTON REMOTE SHELL REPLACEMENT**

This remote is the perfect replacement for a broken or worn out car key remote.

- Make: Mitsubishi.
- Replacement shell.
- Buttons: 3.
- Model: Suits Lancer hatchback & Outlander.

PRODUCT CODE  
**21 KF433**



**MAP**  
**MITSUBISHI 380 4-BUTTON REMOTE SHELL & KEY REPLACEMENT**

This remote is the perfect shell & key replacement for a broken or worn out car key remote.

- Buttons: 4.
- Make: Mitsubishi.
- Shell & key replacement. Requires key cutting.

PRODUCT CODE  
**21 KF436**

■ NISSAN



MAP  
**NISSAN VARIOUS MODELS  
2-BUTTON COMPLETE  
REMOTE**

This remote is the perfect replacement for a broken or worn out car key remote.

- Buttons: 2.
- Make: Nissan.
- Complete remote replacement - Requires key cutting and programming with scan tool.

PRODUCT CODE  
**21 KF297**



MAP  
**NISSAN VARIOUS MODELS  
3-BUTTON COMPLETE  
REMOTE**

This remote is the perfect replacement for a broken or worn out car key remote.

- Buttons: 3.
- Make: Nissan.
- Complete remote - Requires DIY programming.

PRODUCT CODE  
**21 KF298**



MAP  
**NISSAN VARIOUS MODELS  
2-BUTTON COMPLETE  
REMOTE**

This product is the best replacement for a worn or broken key. This is a complete remote, key case and buttons.

- Buttons: 2.
- Suits Nissan: Navara, Dualis & Pathfinder.
- Complete remote with key.

PRODUCT CODE  
**21 KF299**



MAP  
**NISSAN 2-BUTTON  
REPLACEMENT  
FOR REMOTE**

Having trouble with your car remote or its buttons? Get a better option with this product.

- Make: Nissan.
- Model: Various.
- Buttons: 2.
- Remote button replacement.

PRODUCT CODE  
**21 KF302**



MAP  
**NISSAN VARIOUS MODELS  
4-BUTTON  
COMPLETE REMOTE**

This car remote is the replacement for your existing car remote. This tool is a complete remote & key including electronics which will require programming and key cutting.

- Buttons: 4.
- Complete remote.
- Suits: Nissan models.

PRODUCT CODE  
**21 KF308**



MAP  
**NISSAN VARIOUS MODELS  
4-BUTTON  
COMPLETE REMOTE**

This remote is a quick, easy and affordable way to replace your keyless entry remote control car key. Replacement keyless entry remote with battery and electronics installed.

- Make: Nissan.
- Model: Various.
- Buttons: 4.
- Complete remote.

PRODUCT CODE  
**21 KF309**



MAP  
**NISSAN VARIOUS MODELS  
3-BUTTON  
COMPLETE REMOTE**

This product is the best replacement for a worn or broken key. This is a complete remote, key case and buttons.

- Buttons: 3.
- Suits Nissan: X-trail, Pathfinder, Micra & Tiida.
- Complete remote with key.

PRODUCT CODE  
**21 KF400**



MAP  
**NISSAN VARIOUS MODELS  
4-BUTTON REPLACEMENT  
FOR REMOTE**

Having trouble with your car remote or its buttons? Get a better option with this product.

- Make: Nissan.
- Model: Various.
- Buttons: 4.
- Remote button replacement.

PRODUCT CODE  
**21 KF304**



MAP  
**NISSAN VARIOUS MODELS  
3-BUTTON REPLACEMENT  
FOR REMOTE**

Having trouble with your car remote or its buttons? Get a better option with this product.

- Make: Nissan.
- Model: Murano / Pulsar / Tiida / X-Trail.
- Buttons: 3.
- Description: Remote button replacement.

PRODUCT CODE  
**21 KF305**



MAP  
**NISSAN VARIOUS MODELS  
4-BUTTON REPLACEMENT  
FOR REMOTE**

Having trouble with your car remote or its buttons? Get a better option with this product.

- Make: Nissan.
- Model: Maxima / Pathfinder / Patrol / Pulsar.
- Buttons: 4.
- Remote button replacement.

PRODUCT CODE  
**21 KF306**



MAP  
**NISSAN VARIOUS MODELS  
2-BUTTON REMOTE SHELL  
& KEY REPLACEMENT**

This product is the best replacement for a worn or broken key. This is a complete remote, key case and buttons.

- Make: Nissan.
- Model: Various.
- Buttons: 2.

PRODUCT CODE  
**21 KF307**



MAP  
**NISSAN VARIOUS MODELS  
3-BUTTON REMOTE SHELL  
REPLACEMENT**

This remote is the perfect shell replacement for a broken or worn out car key remote.

- Buttons: 3.
- Make: Nissan.
- Replacement shell - requires key cutting.

PRODUCT CODE  
**21 KF401**



MAP  
**NISSAN VARIOUS MODELS  
4-BUTTON REMOTE SHELL  
REPLACEMENT**

This shell is a replacement for your old or damaged remote.

- Make: Nissan.
- Buttons: 4.
- Remote shell replacement.
- Model: Maxima, Pathfinder and Patrol.

PRODUCT CODE  
**21 KF431**



■ SUBARU



MAP  
SUBARU VARIOUS MODELS  
2-BUTTON REMOTE SHELL  
& KEY REPLACEMENT

This product is the best replacement for a worn or broken key. This is a complete remote, key case and buttons.

- Make: Subaru.
- Model: Various.
- Buttons: 2.
- Shell & key replacement only.

PRODUCT CODE  
**21 KF380**



MAP  
SUBARU VARIOUS MODELS  
3-BUTTON REMOTE SHELL  
& KEY REPLACEMENT

This product is the best replacement for a worn or broken key. This is a complete remote, key case and buttons.

- Make: Subaru.
- Model: Various.
- Buttons: 3.
- Shell & key replacement only.

PRODUCT CODE  
**21 KF381**



MAP  
SUBARU VARIOUS MODELS  
3-BUTTON COMPLETE  
REMOTE

This car remote is the complete replacement for your existing car remote. Complete remote & key including electronics which will require programming and key cutting. This tool is suitable for various Subaru models.

- Buttons: 3.
- Description: Complete remote & key including electronics - requires programming & key cutting.

PRODUCT CODE  
**21 KF382**



MAP  
SUBARU VARIOUS MODELS  
3-BUTTON COMPLETE  
REMOTE

This product is the best replacement for a worn or broken key. This is a complete remote, key case and buttons.

- Buttons: 3.
- Suits Various Subaru models.
- Complete remote with key.

PRODUCT CODE  
**21 KF387**



MAP  
SUBARU VARIOUS MODELS  
3-BUTTON COMPLETE  
REMOTE

This car remote is the complete replacement for your existing car remote. This tool is a complete remote & key including electronics which will require programming and key cutting. This tool is suitable for various Subaru models.

- Buttons: 3.
- Description: Complete remote - requires key cutting & programming.

PRODUCT CODE  
**21 KF388**



MAP  
SUBARU VARIOUS MODELS  
3-BUTTON REMOTE SHELL  
& KEY REPLACEMENT

Shell & key replacement.

- Make: Subaru.
- Buttons: 3.

PRODUCT CODE  
**21 KF389**



MAP  
SUBARU VARIOUS MODELS  
3-BUTTON REMOTE SHELL  
& KEY REPLACEMENT

Shell & key replacement.

- Make: Subaru.
- Buttons: 3.

PRODUCT CODE  
**21 KF390**

■ SUZUKU



MAP  
SUZUKI VARIOUS MODELS  
2-BUTTON REPLACEMENT  
FOR REMOTE

This is a replacement button part to match the original in form and function. Best replacement for a key with broken buttons or worn key remote case.

- Buttons: 2.
- Remote button replacement.
- Suits: Suzuki models.

PRODUCT CODE  
**21 KF300**



MAP  
SUZUKI VARIOUS MODELS  
2-BUTTON REMOTE SHELL  
REPLACEMENT

This is a replacement part to match the original in form and function. Best replacement for a key with broken buttons, worn key remote case or a broken remote shell. This case is suited for Suzuki vehicles.

- Buttons: 2.
- Remote button & shell replacement.

PRODUCT CODE  
**21 KF395**



MAP  
SUZUKI VARIOUS MODELS  
2-BUTTON REMOTE SHELL  
REPLACEMENT

This shell is a replacement for your old or damaged remote.

- Make: Suzuki.
- Model: Grand Vitara, Liana & XL7.
- Buttons: 2.
- Remote shell replacement.

PRODUCT CODE  
**21 KF396**



MAP  
SUZUKI SX4 2-BUTTON  
REMOTE SHELL  
REPLACEMENT

This shell is a replacement for your old or damaged remote.

- Make: Suzuki.
- Model: SX4.
- Buttons: 2.
- Remote shell replacement.

PRODUCT CODE  
**21 KF397**

■ TOYOTA



MAP  
TOYOTA VARIOUS MODELS  
4-BUTTON REMOTE SHELL  
REPLACEMENT

This product is the best replacement for a worn or broken key remote. This is a complete remote with buttons. Does not include electronics.

- Buttons: 4.
- Suits Toyota: Aurion, Camry & Kluger.
- Shell replacement, no electronics.

PRODUCT CODE  
**21 KF314**



MAP  
TOYOTA HILUX & YARIS  
2-BUTTON  
COMPLETE REMOTE

This remote is the perfect replacement for a broken or worn out car key remote.

- Buttons: 3.
- Make: Toyota.
- Complete remote - requires customers existing working master key.

PRODUCT CODE  
**21 KF315**



MAP  
TOYOTA AURION  
4-BUTTON  
COMPLETE REMOTE

This product is the best replacement for a worn or broken key. This is a complete remote, key case and buttons.

- Buttons: 4.
- Suits: Toyota Aurion.
- Complete remote replacement - requires DIY programming.

PRODUCT CODE  
**21 KF316**



MAP  
TOYOTA CAMRY 4-BUTTON  
COMPLETE REMOTE

This car remote is the replacement for your existing car remote. This tool is a complete remote & key including electronics which will require programming and key cutting.

- Buttons: 4.
- Complete remote replacement - requires programming.
- Suitable: Toyota Aurion and a Toyota Camry.

PRODUCT CODE  
**21 KF317**

■ TOYOTA (CONTINUED)



**MAP**  
**TOYOTA VARIOUS MODELS**  
**1-BUTTON COMPLETE**  
**REMOTE**

This car remote is the replacement for your existing car remote. This tool is a complete remote & key including electronics which will require programming and key cutting.

- Buttons: 1.
- Complete remote replacement - requires programming.
- Suitable: Toyota Aurion and a Toyota Camry.

PRODUCT CODE  
**21 KF318**



**MAP**  
**TOYOTA VARIOUS MODELS**  
**2-BUTTON COMPLETE**  
**REMOTE**

This car remote is the replacement for your existing car remote. This tool is a complete remote & key including electronics which will require programming and key cutting.

- Buttons: 2.
- Complete remote replacement - requires programming.
- Suit: Toyota Avalon and a Toyota Camry.

PRODUCT CODE  
**21 KF319**



**MAP**  
**TOYOTA VARIOUS MODELS**  
**2-BUTTON REPLACEMENT**  
**FOR REMOTE**

These repair buttons are only replacements for worn/broken, rubber key buttons on your remote. The repair buttons will not fix your remote if the electronic components on the electronic board are missing, not working or are broken.

- Make: Toyota.
- Model: Suits remote with small & large buttons.
- Buttons: 2.
- Remote button replacement.

PRODUCT CODE  
**21 KF320**



**MAP**  
**TOYOTA/NISSAN 1 OVAL**  
**BUTTON REPLACEMENT**  
**FOR REMOTE**

Having trouble with your car remote or its buttons? Get a better option with this product.

- Make: Nissan/Toyota.
- Model: Various.
- Buttons: 1.
- Button Type: Oval.

PRODUCT CODE  
**21 KF321**



**MAP**  
**TOYOTA VARIOUS MODELS**  
**2-BUTTON & REMOTE**  
**SHELL REPLACEMENT**

This product is a replacement shell and button pad for your car remote. Perfect for repairing or renewing your existing remote. This tool is suitable for various models of Toyota.

- Buttons: 2.
- Replacement shell & buttons.

PRODUCT CODE  
**21 KF326**



**MAP**  
**TOYOTA VARIOUS MODELS**  
**3-BUTTON & REMOTE**  
**SHELL REPLACEMENT**

This remote is the perfect shell replacement for a broken or worn out car key remote.

- Buttons: 3.
- Make: Toyota.
- Replacement shell & buttons.

PRODUCT CODE  
**21 KF327**



**MAP**  
**TOYOTA VARIOUS MODELS**  
**4-BUTTON REMOTE SHELL**  
**& KEY REPLACEMENT**

This product is the best replacement for a worn or broken key. This is a complete remote, key case and buttons.

- Make: Toyota.
- Model: Various.
- Buttons: 4.
- Shell & key replacement only.

PRODUCT CODE  
**21 KF328**



**MAP**  
**TOYOTA VARIOUS MODELS**  
**3-BUTTON REMOTE SHELL**  
**& KEY REPLACEMENT**

A quick, easy and affordable way to replace a cracked or worn out keyless entry remote key case or shell. Installation is simple and reprogramming is not required. You must transfer over your original components into this case.

- Make: Toyota.
- Model: Various models including 2 & 3 button.
- Buttons: 3.
- Shell & blade replacement only.
- New key blade must be cut to start the vehicle, please match the key blade style to the original blade..

PRODUCT CODE  
**21 KF329**



**MAP**  
**TOYOTA 2-BUTTON**  
**REPLACEMENT**  
**FOR REMOTE**

Having trouble with your car remote or its buttons? Get a better option with this product.

- Make: Toyota.
- Model: Various.
- Buttons: 2.
- Remote button replacement.

PRODUCT CODE  
**21 KF322**



**MAP**  
**TOYOTA 3-BUTTON**  
**REPLACEMENT**  
**FOR REMOTE**

This is a replacement button part to match the original in form and function. Best replacement for a key with broken buttons or worn key remote case.

- Buttons: 3.
- Remote button replacement.
- Suits: Various Toyota models.

PRODUCT CODE  
**21 KF323**



**MAP**  
**TOYOTA VARIOUS MODELS**  
**1-BUTTON REPLACEMENT**  
**FOR REMOTE**

Having trouble with your car remote or its buttons? Get a better option with this product.

- Make: Toyota.
- Model: Various - round button.
- Buttons: 1.
- Button Type: Round.

PRODUCT CODE  
**21 KF324**



**MAP**  
**TOYOTA VARIOUS MODELS**  
**2 & 3-BUTTON & REMOTE**  
**SHELL REPLACEMENT**

This product is a replacement shell and button pad for your car remote. Perfect for repairing or renewing your existing remote. This tool is suitable for various Toyota models including 2 & 3 button.

- Buttons: 3.
- Replacement shell & buttons.

PRODUCT CODE  
**21 KF325**



**MAP**  
**TOYOTA VARIOUS MODELS**  
**2-BUTTON REMOTE SHELL**  
**& KEY REPLACEMENT**

A quick, easy and affordable way to replace a cracked or worn out keyless entry remote key case or shell. Installation is simple and reprogramming is not required. You must transfer over your original components into this case.

- Make: Toyota.
- Model: Various models 2 button & shell.
- Buttons: 2.
- Shell & blade replacement only.
- New key blade must be cut to start the vehicle, please match the key blade style to the original blade.

PRODUCT CODE  
**21 KF331**



**MAP**  
**TOYOTA VARIOUS MODELS**  
**2-BUTTON COMPLETE**  
**REMOTE**

Complete remote & key, including electronics - requires programming & key cutting. New key blade must be cut to start the vehicle, please match the key blade style to the original blade

- Make: Toyota.
- Model: Various.
- Buttons: 2.

PRODUCT CODE  
**21 KF332**



**MAP**  
**TOYOTA VARIOUS MODELS**  
**2-BUTTON COMPLETE**  
**REMOTE**

This remote is the perfect complete replacement for a broken or worn out car key remote.

- Buttons: 2.
- Make: Toyota.
- Complete remote & key including electronics - requires scan tool programming & key cutting.

PRODUCT CODE  
**21 KF333**



**MAP**  
**TOYOTA RAV4 & YARIS**  
**2-BUTTON REMOTE SHELL**  
**REPLACEMENT**

This remote is the perfect shell replacement for a broken or worn out car key remote.

- Buttons: 2.
- Make: Toyota.
- Replacement shell - requires key cutting.

PRODUCT CODE  
**21 KF410**

■ TOYOTA (CONTINUED)



**MAP**  
**TOYOTA VARIOUS RAV4**  
**2-BUTTON**  
**COMPLETE REMOTE**

Perfect replacement for a damaged or worn out key.

- Make: Toyota.
- Complete key.
- Buttons: 2.
- Model: Suits Rav4 2013 ON models with ignition.

PRODUCT CODE  
**21 KF411**



**MAP**  
**TOYOTA KLUGER**  
**3-BUTTON**  
**COMPLETE REMOTE**

This remote is the perfect replacement for a broken or worn out car key remote.

- Buttons: 3.
- Make: Toyota.
- Complete remote - requires customers existing working master key.

PRODUCT CODE  
**21 KF412**



**MAP**  
**TOYOTA COROLLA**  
**2-BUTTON**  
**COMPLETE REMOTE**

This remote is the perfect replacement for a broken or worn out car key remote.

- Make: Toyota.
- Complete remote.
- Buttons: 2.
- Model: Suits Corolla ZRE182 & ZRE172.

PRODUCT CODE  
**21 KF415**



**MAP**  
**TOYOTA CAMRY 3-BUTTON**  
**COMPLETE REMOTE**

This remote is the perfect replacement for a broken or worn out car key remote.

- Make: Toyota.
- Complete remote.
- Buttons: 3.

PRODUCT CODE  
**21 KF416**



**MAP**  
**TOYOTA VARIOUS MODELS**  
**2-BUTTON COMPLETE**  
**REMOTE**

This remote is the perfect replacement for a broken or worn out car key remote.

- Buttons: 2.
- Make: Toyota.
- Requires programming using existing master key and key cutting.

PRODUCT CODE  
**21 KF425**



**MAP**  
**TOYOTA LANDCRUISER**  
**2-BUTTON**  
**COMPLETE REMOTE**

This remote is the perfect replacement for a broken or worn out car key remote.

- Buttons: 2.
- Make: Toyota.
- Requires programming using existing master key and key cutting.

PRODUCT CODE  
**21 KF426**



**MAP**  
**TOYOTA VARIOUS MODELS**  
**2-BUTTON REMOTE SHELL**  
**REPLACEMENT**

This remote is the perfect shell replacement for a broken or worn out car key remote.

- Make: Toyota.
- Buttons: 2.
- Remote shell replacement.

PRODUCT CODE  
**21 KF428**



**MAP**  
**TOYOTA VARIOUS MODELS**  
**3-BUTTON REMOTE SHELL**  
**REPLACEMENT**

This remote is the perfect shell replacement for a broken or worn out car key remote.

- Make: Toyota.
- Buttons: 3.
- Remote shell replacement.

PRODUCT CODE  
**21 KF429**



**MAP**  
**TOYOTA VARIOUS MODELS**  
**4-BUTTON COMPLETE**  
**KEYLESS REMOTE**

This remote is the perfect replacement for a broken or worn out car key remote.

- Make: Toyota.
- Buttons: 4.
- Complete remote.

PRODUCT CODE  
**21 KF417**



**MAP**  
**TOYOTA HILUX & YARIS**  
**2-BUTTON**  
**COMPLETE REMOTE**

This remote is the perfect replacement for a broken or worn out car key remote.

- Buttons: 2.
- Make: Toyota.
- Complete remote & key including electronics - requires programming & key cutting.

PRODUCT CODE  
**21 KF420**



**MAP**  
**TOYOTA HILUX & YARIS**  
**2-BUTTON**  
**COMPLETE REMOTE**

This remote is the perfect replacement for a broken or worn out car key remote.

- Buttons: 2.
- Make: Toyota.
- Complete remote & key including electronics - requires programming & key cutting.

PRODUCT CODE  
**21 KF422**



**MAP**  
**TOYOTA HILUX & YARIS**  
**2-BUTTON**  
**COMPLETE REMOTE**

This remote is the perfect replacement for a broken or worn out car key remote.

- Buttons: 2.
- Make: Toyota.
- Complete remote & key including electronics - requires programming & key cutting.

PRODUCT CODE  
**21 KF423**



**MAP**  
**TOYOTA VARIOUS MODELS**  
**3-BUTTON REMOTE SHELL**  
**REPLACEMENT**

This remote is the perfect shell replacement for a broken or worn out car key remote.

- Buttons: 3.
- Make: Toyota.
- Shell replacement. Requires key cutting.

PRODUCT CODE  
**21 KF450**



**MAP**  
**TOYOTA VARIOUS MODELS**  
**4-BUTTON REMOTE SHELL**  
**REPLACEMENT**

This remote is the perfect shell replacement for a broken or worn out car key remote.

- Buttons: 4.
- Make: Toyota.
- Shell replacement. Requires key cutting.

PRODUCT CODE  
**21 KF451**



**MAP**  
**TOYOTA VARIOUS MODELS**  
**2-BUTTON REMOTE SHELL**  
**REPLACEMENT**

This remote is the perfect replacement for a broken or worn out car key remote.

- Make: Toyota.
- Replacement shell.
- Buttons: 2.
- Model: Suits Aurion, Camry, C-HR, Corolla, Hilux, Kluger, Prado, Landcruiser, Rav4 & Tarago.

PRODUCT CODE  
**21 KF452**



**MAP**  
**TOYOTA PRADO**  
**2-BUTTON REMOTE SHELL**  
**REPLACEMENT**

This remote is the perfect replacement for a broken or worn out car key remote.

- Make: Toyota.
- Replacement shell.
- Buttons: 2.

PRODUCT CODE  
**21 KF453**

■ TOYOTA (CONTINUED)



**MAP**  
**TOYOTA LANDCRUISER**  
**3-BUTTON REMOTE SHELL**  
**REPLACEMENT**

This remote is the perfect replacement for a broken or worn out car key remote.

- Make: Toyota.
- Replacement shell.
- Buttons: 3.

PRODUCT CODE  
**21 KF454**



**MAP**  
**TOYOTA VARIOUS MODELS**  
**4-BUTTON REMOTE SHELL**  
**REPLACEMENT**

This remote is the perfect replacement for a broken or worn out car key remote.

- Make: Toyota.
- Replacement shell.
- Buttons: 4.
- Model: Suits Camry & Aurion 40 series keyless start.

PRODUCT CODE  
**21 KF455**

■ VOLKSWAGEN



**MAP**  
**VOLKSWAGEN TOUAREG**  
**3-BUTTON REMOTE SHELL**  
**REPLACEMENT**

This shell is a replacement for your old or damaged remote.

- Make: Volkswagen.
- Replacement shell.
- Buttons: 3.
- Suits: Touareg.

PRODUCT CODE  
**21 KF120**



**MAP**  
**VOLKSWAGEN AMAROK**  
**2-BUTTON REMOTE SHELL**  
**REPLACEMENT**

This shell is a replacement for your old or damaged remote.

- Make: Volkswagen.
- Replacement shell.
- Buttons: 2.
- Suits: Amarok.

PRODUCT CODE  
**21 KF122**

■ GARAGE DOOR (CONTINUED)



**MAP**  
**GARAGE DOOR REMOTE**  
**REPLACEMENT**  
**4-BUTTON**  
**ATA PTX4 & HERCULIFT**

This product is suited for replacing your old or worn out garage remote. The remote replaces various ATA PTX4 Trio code devices - Version 1 only!

- Buttons: 4.
- Garage door remote replacement.

PRODUCT CODE  
**21 KF911**



**MAP**  
**GARAGE DOOR REMOTE**  
**REPLACEMENT**  
**2-BUTTON MERLIN DEVICES**

Having trouble accessing your garage door, then we have the right product for you. Replace your garage door remote or its buttons with this product.

- Make: Replaces various Merlin devices.
- Buttons: 2.

PRODUCT CODE  
**21 KF920**



**MAP**  
**GARAGE DOOR REMOTE**  
**REPLACEMENT**  
**3-BUTTON**  
**MERLIN DEVICES**

Having trouble accessing your garage door, then we have the right product for you. Replace your garage door remote or its buttons with this product.

- Make: Replaces various Merlin+ devices.
- Buttons: 3.

PRODUCT CODE  
**21 KF921**



**MAP**  
**GARAGE DOOR REMOTE**  
**REPLACEMENT AVANTI**  
**SUPERLIFT & CENTURION**

Replace your old or damaged garage door remote with this perfect replacement remote.

- Buttons: 4.
- Make: Avanti/Superlift & Centurion.
- Garage door remote replacement.

PRODUCT CODE  
**21 KF935**

■ GARAGE DOOR



**MAP**  
**VOLKSWAGEN VARIOUS**  
**MODELS 3-BUTTON**  
**REMOTE SHELL**  
**REPLACEMENT**

This shell is a replacement for your old or damaged remote.

- Make: Volkswagen.
- Replacement shell.
- Buttons: 3.
- Suits: 3 button flip keys 2000-2012.

PRODUCT CODE  
**21 KF123**



**MAP**  
**GARAGE DOOR REMOTE**  
**REPLACEMENT FOR**  
**3-BUTTON B&D DEVICES**

Having trouble accessing your garage door, then we have the right product for you.

- Make: Replaces various B&D devices.
- Buttons: 3.

PRODUCT CODE  
**21 KF900**



**MAP**  
**GARAGE DOOR REMOTE**  
**REPLACEMENT FOR**  
**4-BUTTON**  
**B&D TRI TRAN CODE**

Replaces various B&D Tri Tran code.

- Buttons: 4.
- Garage door remote replacement.

PRODUCT CODE  
**21 KF901**



**MAP**  
**GARAGE DOOR REMOTE**  
**REPLACEMENT**  
**4-BUTTON**  
**ATA PTX5 & DOMINATOR**

This product is suited for replacing your old or worn out garage remote. The remote replaces various ATA PTX5 Trio code devices - Version 1 only!

- Buttons: 4.
- Garage door remote replacement.

PRODUCT CODE  
**21 KF910**



**MAP**  
**GARAGE DOOR REMOTE**  
**REPLACEMENT**  
**BOSS STEEL-LINE &**  
**CENTURION**

Replace your old or damaged garage door remote with this perfect replacement remote.

- Buttons: 4.
- Make: Steel-Line/Boss & Centurion.
- Garage door remote replacement.

PRODUCT CODE  
**21 KF940**



**MAP**  
**GARAGE DOOR REMOTE**  
**REPLACEMENT**  
**4-BUTTON**  
**GLIDEROL DEVICES**

Having trouble accessing your garage door, then we have the right product for you. Replace your garage door remote or its buttons with this product.

- Make: Replaces various Gliderol TM305C devices.
- Buttons: 4.

PRODUCT CODE  
**21 KF930**



**MAP**  
**GARAGE DOOR REMOTE**  
**REPLACEMENT**  
**4-BUTTON**  
**DOMINATOR**

Replace your old or damaged garage door remote with this perfect replacement remote.

- Buttons: 4.
- Make: Dominator.
- Garage door remote replacement.

PRODUCT CODE  
**21 KF945**



**MAP**  
**GARAGE DOOR REMOTE**  
**REPLACEMENT**  
**DOWNEE MHOUSE &**  
**MOOVO**

Replace your old or damaged garage door remote with this perfect replacement remote.

- Buttons: 4.
- Make: Downee/Mhouse & Moovo.
- Garage door remote replacement.

PRODUCT CODE  
**21 KF949**



**AUNGER SILICONE WIPER REFILLS 24IN**

See clearly and drive safely with these wiper refills that come with a friction modifier coating for smooth wiping. This pack of two is resistant to the harsh weather conditions thus giving you a clear windshield no matter the circumstances.

- Universal fit for 6mm and 8mm backing.
- Friction modified coating.
- Resistant to UV , oil, salt, chemicals, temperature shift.
- Pack of two.
- Colour: Grey.
- Length: 610mm.

PRODUCT CODE  
**19 OEXBB2202** BIG BLUE  
**19 OEXBG2202** BIG GREY  
**19 OEXJB2202** JET BLACK

**AUNGER MULTI EDGE WIPER REFILLS 24IN**

Enjoy a clear and smooth windshield with these high quality wiper refills. The plastic backed and graphite treated rubber wiper refill is built tough for durable wiping performance in any weather!

- Seven wiping edges.
- Plastic backed, graphite treated rubber.
- Universal fit for 6mm and 8mm backing.
- Pack of two.
- Length: 610mm.

PRODUCT CODE  
**19 OEXMW2202**

**AUNGER SINGLE EDGE WIPER REFILLS 24IN**

This single edged wiper refill guarantees an exceptional sweep and clean. The plastic backed and rubber treated graphite makes this product essential in offering a safe driving experience.

- Single edged.
- Plastic backed, graphite treated rubber.
- Universal fit for 6mm and 8mm backing.
- Pack of two.
- Length: 610mm.

PRODUCT CODE  
**19 OEXSE2202**

**EXELWIPE METAL BACK WIPER REFILL 6MM X 650MM 26 INCH PACK OF 20**

Premium 26in metal back twin rail wiper refills. Dimensions 6mm x 650mm.

- Pack of 20.

PRODUCT CODE  
**19 EX6MB650/20**

**EXELWIPE METAL BACK WIPER REFILL 710MM 28 INCH PACK OF 10**

Premium 28in metal back twin rail wiper refills.

Dimensions 6mm x 710mm or 8mm x 710mm.

- Pack of 10.

PRODUCT CODE  
**19 EX6MB710/10** 6MM  
**19 EX8MB710/10** 8MM

**WILDCAT WIPER REFILL TRADE PACK OF 20**

See clearly and drive safely with these wiper refills. These wiper refills come with a friction modifier coating for smooth wiping and is resistant to the harsh weather conditions thus giving you a clear windshield no matter the circumstances.

- Single edge refill.
- Plastic backed, graphite coated rubber.
- Length: 610mm.
- 20 per box.

PRODUCT CODE  
**19 OWRSE24620** 6MM  
**19 OWRSE24820** 8.5MM

**WILDCAT COMPLETE UNIVERSAL WIPER BLADE 18IN**

Get a clear view of the road ahead with these wiper blades. They provide quiet, streak-free wiping performance at an exceptional value. The wiper comes with a complete frame and a graphite coated blade.

- Simply connects to the existing wiper arm.
- Powder coated metal frame.
- Supplied with universal fitting kit.
- Single pack.

PRODUCT CODE  
**19 OWCS18** 18 INCH  
**19 OWCS20** 20 INCH  
**19 OWCS22** 22 INCH



**EXELWIPE  
HYBRID  
WIPER BLADE**

Original smooth flexible style hybrid beam blade, giving a perfect wipe on all types of curved screens, providing superior performance.

- Zinc alloy aluminum base.
- 100% pure natural rubber.
- Anti-friction graphite coating.
- OE quality.
- Even pressure distribution.
- Easy to install.
- UVA resistant.

PRODUCT CODE  
**19 EHF-18-450** 450MM 18 INCH  
**19 EHF-20-500** 500MM 20 INCH  
**19 EHF-22-560** 560MM 22 INCH  
**19 EHF-24-610** 610MM 24 INCH  
**19 EHF-26-650** 650MM 26 INCH



**EXELWIPE  
ULTIMATE  
BEAM WIPER BLADE**

Ultimate beam blade adaptor set required for some European vehicles. This beam blade style covers 95% of the car parc. The beam blade allows the rubber refill to be exchanged.

- Zinc alloy aluminum base.
- 100% pure natural rubber.
- Anti-friction graphite coating.
- OE quality.
- Even pressure distribution.
- Easy to install.
- UVA resistant.

PRODUCT CODE  
**19 EU-14-350** 350MM  
**19 EU-15-380** 380MM  
**19 EU-16-400** 400MM  
**19 EU-17-425** 425MM  
**19 EU-18-450** 450MM  
**19 EU-19-475** 475MM  
**19 EU-20-500** 500MM  
**19 EU-21-525** 525MM  
**19 EU-22-560** 560MM  
**19 EU-24-610** 610MM  
**19 EU-26-650** 650MM  
**19 EU-28-700** 700MM



**EXELWIPE  
ULTIMATE  
HOOK WIPER BLADE UNIVERSAL**

A FlexFlat premium beam blade designed to fit all hook style arms only. 12 lengths available 350mm - 700mm (14in - 28in).

- 100% pure natural rubber.
- Anti-friction graphite coating.
- Carbon steel frame.
- OE quality.
- Latest technology even pressure distribution.
- Low noise.
- High performance clean wipe.
- UVA resistant.

PRODUCT CODE  
**19 HOOK-14-350** 350MM  
**19 HOOK-15-380** 380MM  
**19 HOOK-16-400** 400MM  
**19 HOOK-17-425** 425MM  
**19 HOOK-18-450** 450MM  
**19 HOOK-19-475** 475MM  
**19 HOOK-20-500** 500MM  
**19 HOOK-21-525** 525MM  
**19 HOOK-22-560** 560MM  
**19 HOOK-24-610** 610MM  
**19 HOOK-26-650** 650MM  
**19 HOOK-28-700** 700MM



**EXELWIPE  
ULTIMATE BEAM WIPER BLADE  
ADAPTOR SET**

Ultimate beam blade adaptor set required for some European vehicles.

PRODUCT CODE  
**19 EU-ADAPT**



**EXELWIPE  
ULTIMATE BEAM WIPER BLADE  
ADAPTOR SET**

Ultimate beam blade adaptor set required for some Japanese vehicles.

PRODUCT CODE  
**19 JAP-ADAPT**



**EXELWIPE  
ULTIMATE BEAM WIPER BLADE  
ADAPTOR SET FOR RENAULT**

Ultimate beam blade adaptor set required for some Renault vehicles.

PRODUCT CODE  
**19 V-ADAPT**





**WILDCAT  
LARGE FUNNEL 210MM**

This large funnel is highly durable and is made from oil resistant plastic, making it ideal for liquids such as engine oil, coolant, gasoline, kerosene and other engine fluids.

- Made from petrol and oil resistant plastic.

PRODUCT CODE  
**48 MGLF 210MM**  
**48 MGMF 150MM**  
**48 MGSF 100MM**



**WILDCAT  
FUNNEL EXTRA LARGE 300CM**

This extra large sized funnel is of high quality and is optimal for pouring liquids and is highly durable. The funnel is made from oil resistant plastic thus making it ideal to pour engine oils through it.

- Made from petrol and oil resistant plastic.
- 300mm.

PRODUCT CODE  
**48 MGXF**



**WILDCAT  
4-N-1 MULTI-PURPOSE FUNNEL SET**

The multi-purpose funnel set is ideal for smooth pouring, funnelling or transferring between containers and straining into small bottles or cans - liquids, juices, petroleum, oil, oil changes, coolant, gasoline, kerosene and other fluids.

- 4 piece plastic funnel set.
- Made from petrol and oil resistant plastic.
- Diameters of 50mm, 70mm, 95mm and 115mm.
- Ideal for use in the car, home and boat.

PRODUCT CODE  
**48 M4N1**



**WILDCAT  
FLEXI FUNNEL**

The flexible funnel comes with a mesh filter that filters out damaging particles or debris from liquids. This is a high quality funnel with a flexible spout suitable for liquids like engine oil, coolant, gasoline etc.

- Flexi funnel.
- Mesh filter.
- Removable spout.

PRODUCT CODE  
**48 MGFF**



**WILDCAT  
FAST FLOW FUNNEL**

This silicon funnel is a great addition to your tools and gadgets. This funnel is ideal for transferring both liquid and dry ingredients from one container to another including pouring oils from packets/ bottles into other containers.

- Suitable for fuel, oil and most other liquids.
- Wide spout.
- Fast pouring.
- No mess bottle rest and splash guard.

PRODUCT CODE  
**48 MFFF**



**WILDCAT  
UNIVERSAL LONG REACH FUNNEL**

This long length funnel is ideal for those hard to reach places. It comes with a no-mess splash guard and is suitable for fuel, oil, and most other liquids.

- Long length for hard to reach places.
- Ideal for transmissions and power steering.
- No mess splash guard.
- Suitable for fuel, oil and most other liquids.

PRODUCT CODE  
**48 MFLR**



**WILDCAT  
OIL DRAIN PAN 6L**

The 6L oil drain pan has multiple uses and is great for almost any liquid. It helps to reduce spillage and improves efficiency in pouring.

- Height: 90mm.
- Diameter: 330mm.
- 6 litre capacity.
- Pouring spout included.

PRODUCT CODE  
**48 MGOD**



**WILDCAT  
OIL DRAIN PAN WITH HOLDER 8L**

The 6L oil drain pan has multiple uses and is great for almost any liquid. It helps to reduce spillage and improves efficiency in pouring.

- Height: 110mm.
- Diameter: 340mm.
- 8 litre capacity.
- Pouring spout included.

PRODUCT CODE  
**48 MGODH**



**MIXMIZER INJECTOR  
2 STROKE MIXING TOOL**

Offers the most comprehensive and highest quality offering of fluid handling products. Innovative, no-mess product solutions, whether you're changing your oil, topping off the antifreeze or checking all your automotive fluid levels.

- Measure and mix only what is needed.
- Quart/pint ratio scale.

PRODUCT CODE  
**48 10111**



**WILDCAT  
COPPER END JIGGLE SIPHON 12LPM**

This jiggle siphon hose is ideal for dispensing fuel oils, non-corrosive liquids and adhesives from barrels, tanks and oil drums. Transfer any kind of liquid from one source to another, transfer petrol from or to cars, motorbikes, trucks, boats, lawnmowers etc.

- The jiggle siphon makes siphoning simpler & easy.
- Features a copper head and 1.8m of anti-static hose.
- Perfect for transferring fuel and other liquids.
- Flow rate: 12 Litres per minute.

PRODUCT CODE  
**48 JS12**



**WILDCAT  
PLASTIC END JIGGLE SIPHON 4.5LPM**

This jiggle siphon hose is ideal for dispensing fuel oils, non-corrosive liquids and adhesives from barrels, tanks and oil drums. Transfer any kind of liquid from one source to another, transfer petrol from or to cars, motorbikes, trucks, boats, lawnmowers etc.

- Siphon easily by jiggling the valve in liquid.
- Flow rate: 4.5L/min.
- Hose diameter: 12.5mm.
- Length: 1500mm.

PRODUCT CODE  
**48 JS353**



**WILDCAT  
HAND SIPHON PUMP**

Frequently used as a hand pump in boats for fuel supply to the out-board engine. Easy to clean and works on the vacuum principle. For transfer of liquids such as gasoline, diesel, oil, water etc.

- Easy to use rubber hand squeeze pump.
- Quickly and easily transfers most liquids.
- Portable and easy to store.
- Overall Product Length: 1.8m.

PRODUCT CODE  
**48 PSB**

**WILDCAT  
MULTI PURPOSE TRANSFER PUMP**

Whether your car is out of fuel or in need of an oil change, or you just want to store power equipment for off season by draining its liquid. Quickly transfers liquids and air with just a few easy pumps.

- Ideal for transferring most liquids.
- Doubles as an air pump for inflatables.
- Kit includes: transfer hoses, air pressure hose, dipstick tube and connectors.

PRODUCT CODE  
**48 PSTU**





**WILDCAT  
PINSTRIPES  
3MM SOLID**

This pinstripe can be used for a variety of purposes such as automotive uses, white boards, arts and crafts etc. The pinstripes are durable and easy to fit with all instructions provided on the box.

- Length: 10m roll.
- Width: 3mm.

- PRODUCT CODE
- 05 1101 BLACK
  - 05 1102 WHITE
  - 05 1103 RED
  - 05 1104 MED BLUE
  - 05 1106 GOLD
  - 05 1107 SILVER
  - 05 1199 CHROME



**WILDCAT  
PINSTRIPES  
6MM SOLID**

Universal fit for all cars & motorcycles. The pinstripe vinyl tape can be applied to boats, dashboards, bicycles, helmets, body works and much more. The pinstripes provide a unique look helping in personalising your car bodywork.

- Easy to apply with full fitting instructions.
- 10 metre roll.
- Width: 6mm.

- PRODUCT CODE
- 05 1201 BLACK
  - 05 1202 WHITE
  - 05 1203 RED
  - 05 1207 SILVER
  - 05 1299 CHROME



**WILDCAT  
PINSTRIPES  
9MM SOLID**

Universal fit for all cars & motorcycles. The pinstripe vinyl tape can be applied to boats, dashboards, bicycles, helmets, body works and much more. The pinstripes provide a unique look helping in personalising your car bodywork.

- Easy to apply with full fitting instructions.
- Length: 10m roll.
- Width: 9mm.

- PRODUCT CODE
- 05 11301 BLACK
  - 05 11303 RED
  - 05 11307 SILVER
  - 05 11399 CHROME



**WILDCAT  
PINSTRIPES  
12MM SOLID**

Universal fit for all cars & motorcycles. The pinstripe vinyl tape can be applied to boats, dashboards, bicycles, helmets, body works and much more. The pinstripes provide a unique look helping in personalising your car bodywork.

- Easy to apply with full fitting instructions.
- 10 metre roll.
- Width: 12mm.

- PRODUCT CODE
- 05 11401 BLACK
  - 05 11403 RED
  - 05 11499 CHROME



**WILDCAT  
PINSTRIPES  
9MM DOUBLE**

This pinstripe can be used for a variety of purposes such as automotive uses, white boards, arts and crafts etc. The pinstripes are durable and easy to fit with all instructions provided on the box.

- Length: 10m roll.

- PRODUCT CODE
- 05 1501 BLACK
  - 05 1506 GOLD



**WILDCAT  
PINSTRIPES  
12MM DOUBLE**

This pinstripe can be used for a variety of purposes such as automotive uses, white boards, arts and crafts etc. The pinstripes are durable and easy to fit with all instructions provided on the box.

- Length: 10m roll.

- PRODUCT CODE
- 05 1601 BLACK



**WILDCAT  
PINSTRIPES  
REFLECTIVE RED/WHITE  
25MM X 1M**

The red-white pinstripe tape is great for indoor and outdoor use. The pinstripe can be used for striping automobiles, boats, bikes, motorcycles, or displays. The tape is highly reflective ensuring good visibility of your vehicle.

- Easy to apply with full fitting instructions.
- 1 metre roll.

- PRODUCT CODE
- 05 11600 RED-WHITE



**WILDCAT  
PINSTRIPES  
REFLECTIVE RED  
25MM X 1M**

The red pinstripe tape is great for indoor and outdoor use. The pinstripe can be used for striping automobiles, boats, bikes, motorcycles, or displays. The tape is highly reflective ensuring good visibility of your vehicle.

- Easy to apply with full fitting instructions.
- 1 metre roll.
- Colour: Red.

- PRODUCT CODE
- 05 11697 RED



**WILDCAT  
ADHESIVE BADGE - CHROME RACING**

The 'Racing' chrome badge is an emblem that creates a unique look for your vehicle. It can be placed anywhere on your car. This product features an adhesive taping backing for easy installation.

- High quality chrome badge.
- Adhesive backing for easy installation.
- Dimensions: 100mm x 20mm.

- PRODUCT CODE
- 18 RACING

**WILDCAT  
ADHESIVE BADGE - CHROME SPORT**

The 'Sport' chrome badge is an emblem that creates a unique look for your vehicle. It can be placed anywhere on your car. This product features an adhesive taping backing for easy installation.

- High quality chrome badge.
- Adhesive backing for easy installation.
- Dimensions: 110mm x 35mm.

- PRODUCT CODE
- 18 SPORT

**WILDCAT  
ADHESIVE BADGE - CHROME TURBO**

The 'Turbo' chrome badge is an emblem that creates a unique look for your vehicle. It can be placed anywhere on your car. This product features an adhesive taping backing for easy installation.

- High quality chrome badge.
- Adhesive backing for easy installation.
- Dimension: 140mm x 20mm.

- PRODUCT CODE
- 18 TURBO



**WILDCAT  
ADHESIVE BADGE - CHROME V8**

The 'V8' chrome badge is an emblem that creates a unique look for your vehicle. It can be placed anywhere on your car. This product features an adhesive taping backing for easy installation.

- High quality chrome badge.
- Adhesive backing for easy installation.
- Dimension: 160mm x 45mm.

- PRODUCT CODE
- 18 V8



**WILDCAT  
ADHESIVE BADGE - CHROME DRAGON**

Enhance the appearance of your car with this chrome dragon shaped badge. The adhesive backing makes for easy installation. The dimensions are 45mm x 50mm.

- High quality chrome badge.
- Adhesive backing for easy installation.
- Dimensions: 45mm x 50mm.

- PRODUCT CODE
- 18 DRAGON



**WILDCAT  
ADHESIVE BADGE - CHROME SKULL**

The 'Skull' chrome badge is an emblem that creates a unique look. It can be placed anywhere on your car. This product features an adhesive taping backing for easy installation.

- High quality chrome badge.
- Adhesive backing for easy installation.
- Dimensions: 120mm x 35mm.

- PRODUCT CODE
- 18 SKULL



**WILDCAT  
ADHESIVE BADGE - CHROME 4X4**

The chrome sticker badges are ideal for replacement or adding of numbers zero to nine are available individually.

- High quality chrome badge.
- Adhesive backing for easy installation.
- 85mm x 35mm.

- PRODUCT CODE
- 18 4X4



**WILDCAT  
ADHESIVE BADGE - 3D LIMITED**

Limited edition stick on badge is a 'Limited' emblem that creates a unique look. It can be placed anywhere on your car.

- High quality 3D badge.
- Adhesive backing for easy installation.
- Dimension: 105mm x 25mm.

- PRODUCT CODE
- 18 LIMITED1



**WILDCAT  
ADHESIVE BADGE - 3D SPORT**

The 'Sport' 3D badge is of the highest quality and durability and gives your car a unique look. The badge is easy to apply due to its adhesive backing.

- High quality 3D badge.
- Adhesive backing for easy installation.
- Dimension: 90mm x 15mm.

- PRODUCT CODE
- 18 SPORT1





**ALL BLACKS  
PRECUT MEGA DECAL**

Show your support for the All Blacks with these bumper stickers. Stick them on your vehicle's windows and/or painted panels. The stickers are durable and last longer than standard bumper stickers.

- Easy to apply - professional results.
- Can be removed with no surface damage.
- Will adhere to glass, metal and plastic.

PRODUCT CODE  
**18 ZMLBVAB** BLACK  
**18 ZMLWVAB** WHITE



**ALL BLACKS  
UV PRECUT DECALS SHEET**

Show your support for the All Blacks with this decal sheet. Stick them on your vehicle's windows and/or painted panels. The stickers are durable and last longer than standard bumper stickers.

- Easy to apply - professional results.
- Can be removed with no surface damage.
- Will adhere to glass, metal and plastic.

PRODUCT CODE  
**18 ZUVAB**



**ALL BLACKS  
BUMPER STICKERS SET OF 5**

Show your support for the All Blacks with these bumper stickers. Stick them on your vehicle's windows and/or painted panels. The stickers are durable and last longer than standard bumper stickers.

- Easy to apply - professional results.
- Can be removed with no surface damage.
- Will adhere to glass, metal and plastic.

PRODUCT CODE  
**18 ZBDSAB**



**ALL BLACKS  
SEE THRU DECAL WHITE**

Enhance the appearance of your vehicle with the premium All Blacks decals. With easy application, these decals are easy to install and leaves no permanent damage to your car.

- Easy to apply.
- Can be removed with no surface damage.
- Will adhere to glass, metal and plastic.

PRODUCT CODE  
**18 ZSTLWBAB**

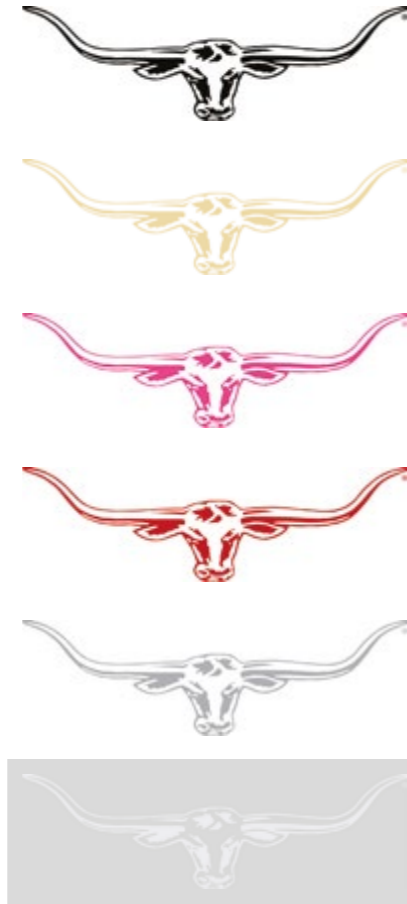

**R.M. WILLIAMS  
LONGHORN DECAL STICKER 70CM**

The RMW Longhorn stickers are designed for outdoor conditions. They are hard wearing, weatherproof and long lasting (on smooth scratch free surfaces). Ideal for cars, boats, fridges and more.

- 70cm wide.
- Easy to install.
- Made from genuine outdoor vinyl.
- Suitable for glass windows or painted panels.
- Available in 6 x colours - White, Black, Pink, Red, Bone & Silver.
- Size: 70cm wide x 21cm high.
- Genuine R.M. Williams Licenced Product.

PRODUCT CODE  
**18 STRMWBLK** BLACK  
**18 STRMWBNE** BONE  
**18 STRMWPNK** PINK  
**18 STRMWRED** RED  
**18 STRMWSLV** SILVER  
**18 STRMWWHT** WHITE



**WILDCAT  
EXTERIOR WRAP  
MATT BLACK - SMALL**

The matte black carbon fibre vinyl is specially formulated for DIY-ers and professionals alike! Lay the vinyl on a surface and simply apply pressure to stick the vinyl firmly. Unlike other films, the adhesive will not damage or eat through paintwork or surface coatings.

- Custom vinyl car wrap.
- For mirrors, sills, handles, petrol flaps.
- Easy to apply.
- Dimensions: 20cm x 150cm. Full fitting instructions included.

PRODUCT CODE  
**17 12226**



**WILDCAT  
EXTERIOR WRAP  
CARBON WHITE - SMALL**

The white carbon fibre vinyl is specially formulated for DIY-ers and professionals alike! Lay the vinyl on a surface and simply apply pressure to stick the vinyl firmly. Unlike other films, the adhesive will not damage or eat through paintwork or surface coatings.

- Custom vinyl car wrap.
- For mirrors, sills, handles, petrol flaps.
- Easy to apply.
- Dimensions: 20cm x 150cm. Full fitting instructions included.

PRODUCT CODE  
**17 12243**



**WILDCAT  
INTERIOR WRAP  
3D GUN METAL CARBON FILM**

Change the colour of the interior of your car with this 3D gun metal carbon film. This film also protects the interior of your car and is highly durable.

- Self adhesive film.
- Useful for coordinating interior colours.
- Can also be used for marine applications.
- 500mm x 1m.

PRODUCT CODE  
**17 19950**



**WILDCAT  
FOR SALE SIGN  
DIY DECAL SHEET**

This 'For Sale' decal sheet is an easy DIY product which helps in sale of your items by adding a more visible and prominent look to your product. Great for selling cars.

- DIY Sticker kit.
- 1 x For Sale Sign
- 3 x Numbers 0 to 9
- Various symbols.

PRODUCT CODE  
**18 PS007**

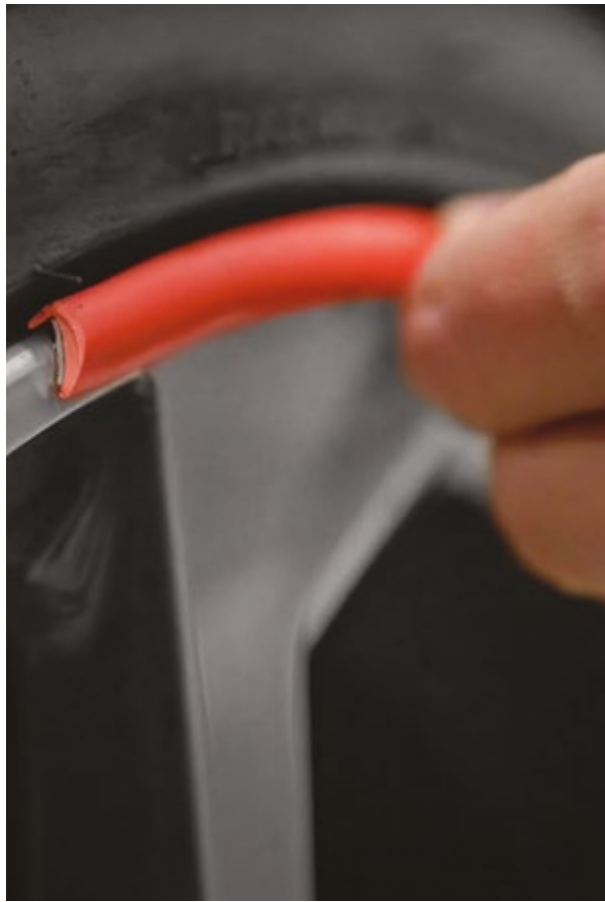

**TYPE S  
SELF ADHESIVE  
RIM ACCENT TRIM**

Choose this all-fit accent trim for wheels when you want to add a pop of colour to your rims. The TYPE S 3.86m Rim Trim Wheel Accent can be trimmed to fit rims of almost any size.

- Enhance the look of your rims and bring some style to the road.
- Easy application with an extra strong 3M VHB adhesive.
- Built-in UV resistant material and a weatherproof design.
- Designed to fit most vehicles.
- Kit contains: 3.86m Rim Accent, Alcohol Wipe, 2x Adhesion Promoter, Quick Installation Guide.

PRODUCT CODE  
**90 AC56129 RED**  
**90 AC56130 BLUE**



**TYPE S  
UNIVERSAL BLACK  
FRONT BUMPER SPOILER 2.48M**

Give your car an aggressive look with the Universal Front Bumper Spoiler. This kit brings true performance style to your ride without breaking the bank. Extruded from durable rubber, the lip kit protects against minor scrapes and scuffs.

- Custom Sizing - trim to fit most cars.
- Designed for Contoured Bumpers; Pre-cut notches for seamless attachment to curved bumpers.
- Durable Performance; UV Resistant to last year round.
- Flexible Style; install multiple kits to cover entire underbody.
- DIY Installation; install from the convenience of your garage.

PRODUCT CODE  
**44 AC56222**



**TYPE S  
UNIVERSAL BLACK  
REAR SPOILER KIT 1.49M**

The Universal Rear Spoiler Kit is a trim-to-fit, cost-effective solution that upgrades the look of your ride. This kit includes installation prep gear and fitted finishing caps.

- Upgrade Vehicle Style; includes fitted end caps for professional look.
- Quality Design; premium material and finish.
- Durable Performance; UV Resistant to last year round.
- DIY Installation; includes prep kit and backed with 3M VHB Tape.

PRODUCT CODE  
**44 AC57371**



**WILDCAT  
AIR SCOOP VENT  
WITH MESH GRILLE**

The hood vent acts as a decorative trim for your car or you can drill a hole on your hood to scoop in more air for engine turbo! This vent will enhance the impression of your car.

- Bonnet or fender mounted.
- Includes pre-applied self-adhesive tape.
- ABS material, may be painted.
- 405mm x 265mm.

PRODUCT CODE  
**44 119601**



**WILDCAT  
AIR SCOOP VENT  
WITH MESH GRILLE**

The hood vent acts as a decorative trim for your car or you can drill a hole on your hood to scoop in more air for engine turbo! This vent will enhance the impression of your car.

- Bonnet air vent.
- Silver mesh grille.
- Includes pre-applied self-adhesive tape.
- 500mm x 210mm x 50mm.

PRODUCT CODE  
**44 119603**



**WILDCAT  
AIR SCOOP VENT  
WITH MESH GRILLE**

The hood vent acts as a decorative trim for your car or you can drill a hole on your hood to scoop in more air for engine turbo! This vent will enhance the impression of your car.

- Bonnet air vent.
- Silver mesh grille.
- Includes pre-applied self-adhesive tape.
- 395mm x 360mm x 50mm.
- ABS material, may be painted.

PRODUCT CODE  
**44 11973**

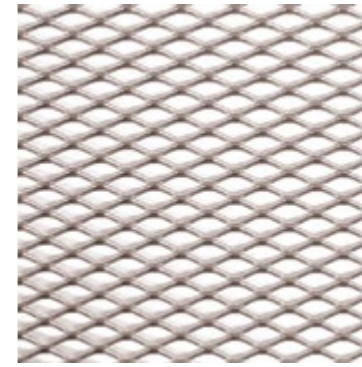

**WILDCAT  
DIAMOND ALUMINIUM MESH**

Make your vehicle look more stylish while also protecting it from road debris using this silver diamond mesh. The silver mesh can be used on bumper bars, body kits, bonnet scoops, grills & side skirts.

- Aluminium mesh sheet diamond pattern.
- Use for bumper bars, body kits, bonnet scoops, grills & side skirts.
- Can be cut to any size and shape.
- Dimensions: 1.2M x 280mm.

PRODUCT CODE  
**44 19970 SILVER**  
**44 19971 BLACK**



**WILDCAT  
HEX  
ALUMINIUM MESH**

Make your vehicle look more stylish while also protecting it from road debris using this silver diamond mesh. The silver mesh can be used on bumper bars, body kits, bonnet scoops, grills & side skirts.

- Aluminium mesh sheet hex pattern.
- Use for bumper bars, body kits, bonnet scoops, grills & side skirts.
- Can be cut to any size and shape.
- Dimensions: 1.2M x 280mm.

PRODUCT CODE  
**44 19975 BLACK**



**WILDCAT  
HOOD PIN KIT WITH HAIR PIN 2 PACK**

Keep your hood closed in style with this hood pin set. These hairpin sets are made from durable materials that are superior in quality and durable.

- Chrome.
- Kit includes cable.
- Two per pack.

PRODUCT CODE  
**44 1529**



**WILDCAT  
HOOD PIN KIT  
WITH BLACK SILICONE HOOK  
2PACK**

This universal application kit is designed to be used in conjunction with the OE hood latch, and includes necessary mounting hardware to ensure easy installation.

- Two per pack.
- Black silicone bonnet hooks.
- Includes mounting brackets.

PRODUCT CODE  
**44 1537**



**WILDCAT WEATHER STRIP TAPE 19MM X 1.8M**

Sponge rubber self-adhesive tape. Helps seal doors and windows, which can reduce your energy bills. It is also waterproof.

- Waterproof.

PRODUCT CODE  
**57 WS6**

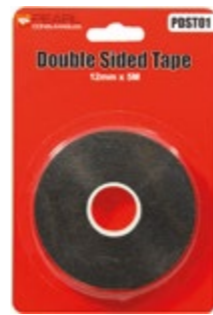

**WILDCAT DOUBLE SIDED TAPE 5M**

This roll of Double Sided Tape provides an adhesion that is strong and durable enough to cope with all the movement and vibrations caused by uneven road surfaces when you are driving.

- Double sided tape supplied in a roll.
- Adhesive on both sides of the tape.
- Incredible adhesive power which has many varied uses.

PRODUCT CODE  
**57 PDST01** 12MM  
**57 PDST02** 18MM



**WILDCAT CLOTH TAPE 50MM X 25M GREY**

To suit many purposes around the home and garage. A durable tape with strong adhesion. Often referred as RACE TAPE. Also available in Black

PRODUCT CODE  
**57 CT5025GY**



**WILDCAT LENS REPAIR TAPE 5CM X 150CM**

When a tail light or turn signal light cracks, this lens repair tape is the answer for a quick repair that will securely hold. The repair tape combines benefits that include exceptional clarity, strong adhesion and a reliable bond.

- Repairs cracked or broken lens.
- Available in three colours: Red, Amber or Clear.

PRODUCT CODE  
**57 91393** RED  
**57 91394** AMBER  
**57 91395** CLEAR



**1ST GEAR OUTDOOR GREY CAR COVER**

1st Gear car covers protect your car against rain, wind, UV rays, snow, dust, and birds. The revolutionary spun bonded material is 100% breathable, highly water repellent and UV resistant.

- 100% breathable.
- Ideal for cars or boats.
- Includes heavy duty eyelets for under vehicle securing.

PRODUCT CODE  
**20 FGCCMED** M – 430 X 160 X 120CM  
**20 FGCCLGE** L – 480 X 175 X 120CM  
**20 FGCCXLG** XL – 530 X 175 X 120CM



**WILDCAT STAINLESS STEEL NUMBER PLATE FRAME PAIR**

This number plate frame is crafted from high quality stainless steel for long-lasting corrosion protection. This sleek and simple frame is rustproof ensuring durability and superior protection against the elements.

- Attaches to vehicle behind the number plate.
- Two per pack.

PRODUCT CODE  
**45 NPSS**



**WILDCAT NUMBER PLATE FRAME PAIR**

Dress up your license plate and give your vehicle a consistent upgraded style with this black license plate frame.

- Number plate clips into surround.
- Two per pack.

PRODUCT CODE  
**45 NPBP** BLACK  
**45 NPBU** BLUE  
**45 NPCH** CHROME  
**45 NPRD** RED  
**45 NPWW** WHITE



**WILDCAT PLAIN BLACK TYRE COVER**

Spare wheel cover easy to use and remove, no tools required. Protect the tyre and wheels from sun, dirt, corrosion and all types of weather.

- Fleecy lined with an elastic draw string.
- Protects tyre and wheel from all weather.
- Quality, easy to clean UV stable vinyl.
- **Standard** fits tyres 650mm to 720mm in diameter.
- **Large** fits tyres 650mm to 780mm in diameter.

PRODUCT CODE  
**45 TCP** STANDARD  
**45 TCPL** LARGE



**ALL BLACKS NUMBER PLATE FRAME PAIR**

Show your support for the All Blacks at the front of your car with this number plate. The number plate has a simple clip on fitting for easy installation and convenience.

- Two per set.

PRODUCT CODE  
**45 ABNP217**



**WILDCAT SQUARE CHROME FINISH UNIVERSAL DOOR MIRROR**

The square door mirror is designed to be a universal replacement for most small original equipment mirrors on most cars.

- Complete with screws and mounting pad.
- Bright chrome finish.
- Door or wing mount.
- Left or right hand.
- Fits most cars.

PRODUCT CODE  
**46 370C**



**WILDCAT LARGE CLIP ON TOWING MIRROR**

These towing mirrors fit over the existing side mirror to provide added vision while towing. They are fully adjustable and do not obstruct your existing mirror.

- Ideal for vehicles towing caravans.
- Fits both driver & passenger side mirrors.
- Extra large size.
- Easy clip-on installation, no tools required.

PRODUCT CODE  
**46 QFT96**



**WILDCAT TRAILER REGISTRATION STICKER HOLDER**

This trailer registration sticker holder makes it easy to display your registration for trailers, trucks, and motorcycles. The sticker holder convenient to manage your registration sticker and keep it in a secure place.

- Rego holder for trailers, trucks and motorcycles.
- Convenient and portable.
- In a display blister pack.

PRODUCT CODE  
**47 MRLHBL**



**TRAILER TOW BALL COUPLING ANTI-THEFT LOCK**

PROTECT YOUR TRAILER FROM THEFT BY INSTALLING THIS TRAILER LOCK.

PROVIDES SECURITY TO YOUR TRAILER AT ALL TIMES.

- Prevents unauthorised towing.
- Fits all popular couplings.
- Expands in the coupling.

PRODUCT CODE  
**47 LK178 1-7/8 INCH**  
**47 LK50 50MM**



**WILDCAT PLASTIC CHROME TOW BALL COVER**

This chrome tow bar cover will help keep your tow bar, brackets and quick-disconnect crossbar free of dirt and road grime when not in use, ensuring smooth and easy tow bar operation.

- Fits 50mm and 1 7/8 inch tow balls.

PRODUCT CODE  
**47 TBC**



**WILDCAT D SHACKLE 10MM**

Secure your chain with this Wildcat D Shackle 10mm

- Solid construction.

PRODUCT CODE  
**29 D10 10MM**  
**29 D8 8MM**



**WILDCAT INTERIOR SUCTION REAR VIEW MIRROR**

The interior rear view mirrors are designed and made using the highest quality materials to ensure lasting quality and durability. Ideal for driving instructors and/or keeping an eye on children in the back as well as increased visibility.

- Lever action suction cup interior mirror.
- Dimensions - W: 18cm x H: 6.5cm.

PRODUCT CODE  
**46 MIS**



**WILDCAT PANORAMIC REAR VIEW MIRROR**

The panoramic rear-view mirror eliminates all blind spots and provides a wider angle view than conventional mirrors. They securely clip on and off over your present mirror making it a convenient addition to your car.

- This convex mirror gives multi lane visibility.
- Helps to eliminate blind spots.
- Installs over existing rear view mirror.

PRODUCT CODE  
**46 5961**



**WILDCAT WARRANT OF FITNESS HOLDER**

A handy product that can be used as a WOF holder for all cars, trailers and bikes. It permits you to safely keep and manage your Warrant of Fitness document.

- WOF holder for all car trailers and bikes.
- Convenient and portable.

PRODUCT CODE  
**47 MRWOF**



**WILDCAT ELASTIC OCCY BUNGEE CORD**

Fast and effective way to tie down loads. Ideal for roof racks, jet skis, trailers and boats. 10mm multiple elastic rubber bungee cord. For general light loads only.

- Heavy duty powder coated metal hooks.

PRODUCT CODE  
**29 AOS450 450MM**  
**29 AOS600 600MM**  
**29 AOS900 900MM**  
**29 AOS120 1200MM**



**WILDCAT RATCHET TIE DOWN 180KG PAIR**

Secure your cargo and travel with peace of mind. The Wildcat Ratchet Tie Down is easy to tighten and release, and can handle up to 180kg of weight. The hooks are vinyl coated to minimise scratches and clanking.

- Easy to tighten and release.
- Fitted with two vinyl-coated hooks.
- Nylon strap: 25mm wide, with 180kg capacity.
- Adjusts from 1200mm to 4600mm length.
- Two per pack, packaged in double blister card.

PRODUCT CODE  
**29 TD180-2**



**WILDCAT BLUE ADJUSTABLE BUMPER MARKER**

The blue adjustment bumper marker is designed with the aim to make parking easier by allowing you to see how close your bumper is to objects for easy parking. The swivel base allows for different attachment angles.

- Swivel base allows for different attachment angles.
- Includes self-adhesive tape.
- May be removed before using car wash machines.

PRODUCT CODE  
**50 BMA**



**WILDCAT BLIND SPOT MIRROR 75MM**

Round style convex blind spot mirror. Eliminates blind spots for safer driving. Features convenient stick-on mounting.

PRODUCT CODE  
**46 BSM75**



**WILDCAT  
WHEEL CLAMP LOCK**

This heavy-duty lock clamp is a perfect anti-theft device that will completely immobilise a wheel from rotating or turning. Simply attach to your wheel, pocket the keys and walk away calmly knowing that your vehicle is once again safe.

- Made of heavy duty hardened steel.
- Highly visible protection.
- Easy installation.
- PVC coated to protect wheels from damage.
- Portable and easy to store.

PRODUCT CODE  
**47 KWL1**



**WILDCAT  
UNIVERSAL FUEL CAP**

Universal fuel cap acts as a temporary fix in case of a stolen or lost fuel cap. Prevents evaporation of fuel in the case of a lost of missing cap.

- Spiral flutes grip filler neck.
- Simple wind in.
- Held in place by spring tension.
- Designed for emergency use only.

PRODUCT CODE  
**48 FC**



**WILDCAT  
ROAD SIDE EMERGENCY  
BREAKDOWN KIT  
4 PIECE**

You never know where the road may lead or what may happen, so don't be caught unprepared. The breakdown kit is small and compact for easy storage. This kit keeps you ready should your vehicle suffer a breakdown.

- Four piece kit contains a 200Amp surge protected jumper leads, cotton gloves, flashlight/torch and a 2000kg tow rope with hooks.

PRODUCT CODE  
**29 EK1**



**WILDCAT  
TOW ROPE 3 TONNE**

This high strength towing strap will make easy work of recovering broken-down or stuck vehicles. With a 3000Kg capacity you'll have plenty of slack to get to vehicles stuck down hill or in other precarious places.

- Nylon rope.
- Protective sheathing at each end.
- Spliced hooks.
- Featuring quick snap-on safety hooks on both sides, you can have this strap fitted up in no time.

PRODUCT CODE  
**29 TR3**



**WILDCAT  
ANTI STATIC STRAP**

Prevent the unpleasant shock caused by the potential difference of static electricity when touching the car body or other areas. Reduced static accumulation of dust and reflector means your car can be easily seen by other vehicles and pedestrians.

- Designed to remove a vehicle's static electricity.
- Rubber outer with metal rod.
- Complete with mounting bracket.

PRODUCT CODE  
**47 AS720**



**WILDCAT  
SOLDER ROLL  
100G**

A self-fluxing multi-core solder. For all electrical and electronic applications. 60% Tin / 38% Lead / 2% Resin Flux.

PRODUCT CODE  
**47 SR100**



**WILDCAT  
SOLDER ROLL  
17G**

A self-fluxing multi-core solder. For all electrical and electronic applications. 60% Tin / 38% Lead / 2% Resin Flux.

PRODUCT CODE  
**47 SR17**



**WILDCAT  
SOLDER ROLL 1.5MM  
500G**

A self-fluxing multi-core solder. For all electrical and electronic applications. 60% Tin / 38% Lead / 2% Resin Flux. Thicker 1.5mm diameter where more solder is needed.

PRODUCT CODE  
**47 SR500**



**WILDCAT  
UNIVERSAL  
MUDFLAP PAIR**

Drive stress free without worrying about your car getting dirty due to mud or slush. These mud flaps will not only protect your vehicle from getting dirty but will also enhance the look of your vehicle.

- Universal fit front or rear mud flaps.
- Screws and washers included.
- Two per pack.

PRODUCT CODE  
**47 MFUN1**



**TYPE S  
DOOR PROTECTOR  
BLACK REFLECTORS SET4**

Prevent your car door from scratches and dents with this car door protector. The door protector is equipped with reflectors to improve your car's visibility during the night time or in poorly lit areas.

- Protects car doors from dents and scratches.
- Easy installation, just peel and stick.
- Stylish design with inbuilt reflectors.
- Set of 4.

PRODUCT CODE  
**50 DPB**



**WILDCAT  
CIGARETTE LIGHTER  
KIT**

Whether you're looking to buy a new kit or replace an existing cigarette car lighter, this is the ideal product for you. The plunger pops out automatically when ready.

- 10 amps / 120 watts maximum current rating.
- Built in heat resistant ceramic protector.
- Suitable for most 12 volt car battery systems.

PRODUCT CODE  
**47 CL12B**



**MICHELIN  
ANALOGUE  
FOOT PUMP**

This analogue foot pump is a compact, portable foot pump for all inflatable needs. The compact size makes it simple to store and its easy foot pump design makes it quick and effortless to inflate tyres.

- Dual display for PSI / BAR.
- Analogue gauge accurate to +/- 1 PSI up to 50 PSI.
- Ergonomic rubber tread plate.
- Incorporates snap-in adaptor storage.

PRODUCT CODE  
**90 12204**



**MICHELIN  
ANALOGUE  
DOUBLE FOOT PUMP**

With its super sturdy steel frame you can inflate your tyres with ease using the Michelin analogue double barrel foot pump which has twin barrels for high volume inflation. The foot pump comes with a sturdy wide footprint steel frame with rubber feet.

- Dual display for PSI / BAR.
- Analogue gauge accurate to +/- 1 PSI up to 50 PSI.
- Incorporates snap-in adaptor storage.

PRODUCT CODE  
**90 12206**



**MICHELIN  
DIGITAL FOOT PUMP**

With its super sturdy steel frame you can inflate your tyres with ease using the Michelin digital foot pump which has a single barrel for high volume inflation. The foot pump comes with a sturdy wide footprint steel frame with rubber feet.

- Digital display for PSI, BAR and kPa.
- Digital gauge accurate to +/- 1 PSI up to 50 PSI.
- Ergonomic rubber tread plate.
- Incorporates snap-in adaptor storage.

PRODUCT CODE  
**90 12208**



**MICHELIN  
MICRO TYRE INFLATOR**

Correct tyre pressure minimises tyre wear, aids fuel consumption and benefits road holding and handling. This compact tyre inflator is designed to be stored anywhere with clear easy pressure reading. It is compatible with all cars, bikes, bicycles and even basketballs & footballs.

- Designed for topping up tyre pressure
- Able to switch between PSI, BAR and kPa
- Built in USB socket ideal for charging mobile phones
- Compact design allows for glove box storage
- White LCD digital display

PRODUCT CODE  
**90 12264**



**WILDCAT  
DOUBLE BARREL  
FOOT PUMP**

The double barrel foot pump is suitable for high volume/high speed fills. The foot pump comes with an all metal design with 4mm thick steel base. The product includes 600mm hose, thumb lock connector for tyres, and nozzle for air beds and sports balls.

- Gauge marked: 0-100psi and 0-7 bar.
- All metal design.

PRODUCT CODE  
**90 FP90G**



**WILDCAT  
FOOT PUMP  
WITH GAUGE**

Don't let a flat tyre ruin your road trip. Instead get this air pump and you can quickly inflate the tyre back to the ideal pressure and get back on road. This air pump does not require electricity but instead works like a cycle pump.

- Gauge readings 0-100psi.
- Compact, heavy duty design.

PRODUCT CODE  
**90 PF**



**WILDCAT  
HAND PUMP**

This pump is engineered to deliver air for all products requiring inflation. Automotive and trailer tyres, air mattresses, bike tyres, inflatable rafts and boats; this hand pump will do the job.

- Metal body.
- Foot support.
- Fitted with quick release chuck.

PRODUCT CODE  
**90 PH**



**WILDCAT  
MINI AIR COMPRESSOR 12V**

This 12-Volt portable air compressor with a pressure gauge is perfect to inflate tyres on cars, sports balls, road bicycles, motorcycle, air mats, toys and so on. This air compressor is also equipped with a 250 PSI precise dial pressure gauge provides more accuracy.

- 250psi pressure gauge.
- 3m power cable.
- In-line rotary power switch.
- 12V plug.
- Includes adaptors.

PRODUCT CODE  
**90 PAC**



**DR AIR TYRE INFLATION ADAPTOR KIT**

The tyre inflation kit contains the tools to help inflate your tyres and/or balls. The kit is an inflation adaptor set.

- The kit contains a nozzle adaptor, ball needle and a brass adaptor.

PRODUCT CODE  
**90 TG35**



**DR AIR DIAL TYRE GAUGE PLASTIC 50PSI**

This gauge is a tool to regularly check tyre pressure. Check your tyres easily and get quick, accurate results.

- Calibrated 10-50psi.
- Dual scale KPA/LBS.
- Plastic body.
- Acrylic lens.

PRODUCT CODE  
**90 TG1**



**DR AIR DIAL TYRE GAUGE METAL 60PSI**

Deluxe precision tyre gauge with easy to read dial. 0 to 60 psi/kpa range. Pressure release button, angled head and shock resistant body. Comes with plastic carry case.

- Metal body with glass lens.
- Angled head.
- Pressure release button.
- Shock resistant body.
- Accurate measurement.
- Suitable for all vehicles.
- Calibrated 10-60psi.
- Dual scale lbs/kpa.

PRODUCT CODE  
**90 TG4A**



**MICHELIN DIGITAL TYRE GAUGE**

This compact gauge allows you to check both tyre pressure and tread depth. Maintaining the correct tyre pressure is fundamental. It maximizes the performance and fuel efficiency whilst increasing passenger safety and comfort.

- Large digital display.
- Range: 5 to 99 PSI, 40 to 680 kPa, 0.4 to 6.80 BAR.
- Accuracy: +/- (1% + 1 LSD)

PRODUCT CODE  
**90 MN4203**



**DR AIR PENCIL TYRE GAUGE 100LB**

Pencil tyre gauges provide a simple way to ensure your tyres stay properly inflated. Maintaining proper tyre pressure reduces fuel consumption and maximizes tyre tread life, making your tyres last longer and perform better. The gauge comes with a chrome plated head.

- Metal body.
- Dual scale KPA/LBS.
- Suitable for passenger cars, vans, light trucks.

PRODUCT CODE  
**90 TG9**



**DR AIR PENCIL TYRE GAUGE 50LB**

Pencil tyre gauges provide a simple way to ensure your tyres stay properly inflated. Maintaining proper tyre pressure reduces fuel consumption and maximizes tyre tread life, making your tyres last longer and perform better. The gauge comes with a chrome plated head.

- Range of 5-50 psi.
- Dual scale KPA/LBS.
- Suitable for passenger cars, vans, light trucks.

PRODUCT CODE  
**90 TG8**



**DR AIR TYRE VALVE CORE SET PK4**

The tyre valve core replacement is the perfect replacement valve core to provide an air tight seal when screwed snugly into the valve core chamber. Designed with a seal attached to a movable, spring-loaded pin which allows pressurized air to pass when inflating a tyre.

- Standard valve cores.
- 0-60 psi/kpa range.

PRODUCT CODE  
**90 TG24**



**DR AIR TYRE VALVE TOOL 4-WAY**

This 4-way valve tool with 4 valve cores is compatible for all vehicle valves. The 4-way tool helps in removing valve cores and replacing them with the new units.

- Repair the inside/outside of damaged valve thread.
- Inserts and removes valve cores.
- Metal construction.

PRODUCT CODE  
**90 TG19**



**DR AIR RUBBER TYRE CEMENT**

This product ideal for adhering rubber patches to punctured tyre tubes

PRODUCT CODE  
**90 TG31**



**DR AIR RUBBER TYRE REPAIR KIT**

Having trouble with your rubber tyre? Try out this rubber tyre repair kit, it has all the essentials to get your tyre back on track. The kit contains a tube of rubber glue, rubber repair patches and a tyre preparation tool.

- Tube of rubber glue.
- Rubber repair patches
- Tyre preparation tool.

PRODUCT CODE  
**90 TG32**



**DR AIR TUBELESS TYRE REPAIR KIT**

Got a flat on your tubeless tyre? Look no further as this tyre repair kit can help fix your tubeless tyre.

- Kit includes: Tube of rubber cement, foldable metal scourer, piercing/threaded spike, tyre file spike, 5 x tyre repair plugs.

PRODUCT CODE  
**90 TG36**



**LIQUID TYRE REPAIR PATCH 250ML**

Liquid Patch is a fibre based puncture sealant, which immediately and permanently protects both tube and tubeless tyres against punctures in the tread area up to 6mm (1/4in) in diameter. The repair occurs while you are driving and is permanent.

- Easily installed and long lasting.
- Reduces down-time and costly repairs.
- Suitable for tube and tubeless tyres.

PRODUCT CODE  
**90 LP250 250ML**  
**90 LP500 500ML**



**DR AIR RUBBER TUBE REPAIR KIT**

Repair your tyres with this handy rubber tube repair kit.

- Kit includes: Tube of rubber glue, rubber repair patches, tyre preparation tool.

PRODUCT CODE  
**90 TG33**

**DR AIR BICYCLE TYRE MAINTENANCE KIT**

This tyre maintenance kit from Dr. Air contains all the necessary equipment required to repair and regularly maintain your bicycle.

- Includes: dumbbell wrench 6-15mm, tyre levers x 2, valve caps x 2, 25mm diameter rubber patches x 2, 51mm x 33mm rubber patch x 1, rubber cement tube and steel buffer.

PRODUCT CODE  
**90 TG34**





**WILDCAT TYRE VALVE CAPS PK5**

Decorate your tyres with stylishly designed valve caps! These valve caps are superior in quality with strength and durability. These caps help prevent air leakage and stop dust, dirt, and unwanted objects from damaging the tyre cores.

- Set of 5 caps in display pack.

PRODUCT CODE  
**90 194225 SILVER**  
**90 194245 BLUE**  
**90 194255 RED**



**WILDCAT GRENADE TYRE VALVE CAPS PK4**

Add style to a plain old car wheels with a set of grenade valve caps.

- Display pack includes a set of four chrome hand grenade valve caps.

PRODUCT CODE  
**90 195000**



**WILDCAT LOCK NUT SET PK20 THIN SHAFT 1.25**

The lock & nut set is perfect for replacing rusted or broken lug nuts. Great for showing off your wheels and enhancing the overall look of your vehicle.

- 17mm slim fit shaft, 7 spline nuts.
- Heat treated tapered wheel nuts.
- Triple nickel plating.
- Pack of 20.

PRODUCT CODE  
**94 S12520BL BLACK**  
**94 S12520CH CHROME**



**DR AIR BLACK PLASTIC TYRE VALVE CAPS PK4**

These black nylon plastic caps help prevent air leakage and stop dust, dirt, and unwanted objects from damaging the tyre cores.

- Set of 4 nylon caps.

PRODUCT CODE  
**90 TG14**



**WILDCAT LOCK NUT SET PK20 THIN SHAFT 1.5**

The lock & nut set is perfect for replacing rusted or broken lug nuts. Great for showing off your wheels and enhancing the overall look of your vehicle.

- 17mm slim fit shaft, 7 spline nuts.
- Heat treated tapered wheel nuts.
- Triple nickel plating.
- Pack of 20.

PRODUCT CODE  
**94 S1520BL BLACK**  
**94 S1520CH CHROME**



**WILDCAT MAG NUT & WASHER LOCK NUT SET**

This product gives drivers the option to add style to their wheels. These wheel nuts are attractive as well as quality-tested for strength, durability, and longevity.

- Shank and washer to suit mag wheel.
- Set of four lock nuts and lock key.
- In clam shell packaging.

PRODUCT CODE  
**93 MAG15**



**WILDCAT MAG WASHER**

Mag washers to cover a wide variety of wheel applications.

- Mag wheel nut replacement washer.
- Sold individually.

PRODUCT CODE  
**95 MW**



**WILDCAT MAG NUT & WASHER**

This product gives drivers the option to add style to their wheels. These wheel nuts are attractive as well as quality-tested for strength, durability, and longevity.

- Mag wheel nut and washer set.
- Set of four.
- In clam shell packaging.
- Available in other sizes.

PRODUCT CODE  
**94 A12-4 1/2 IN PK4**  
**94 A125-4 12 X 1.25MM PK4**  
**94 A15-4 12 X 1.5MM PK4**  
**94 A716-4 7/16 IN PK4**



**WILDCAT WHEEL BRACE 4-WAY**

This cross wrench is designed for a variety of vehicles with 17mm, 19mm, 21mm & 23mm wheel nuts and suitable for tightening and loosening of wheel nuts on cars and light vans. Cross design gives extra turning leverage torque for easy use.

- Fits 17mm, 19mm, 21mm and 23mm wheel nuts.

PRODUCT CODE  
**90 TWB**



**WILDCAT TAPERED SEAT LOCK NUT SET**

These lug nuts are durable, yet light weight and have thin wall construction. The size of these lug nuts is designed to fit wheel holes found on modern muscle cars, sport trucks, and SUVs. A knurled perimeter top allows for easy installation.

- Taper seat wheels
- Set of four lock nuts and lock key.
- In clam shell packaging.

PRODUCT CODE  
**93 STE12 1/2IN**  
**93 STE125 12 X 1.25MM**  
**93 STE15 12 X 1.5MM**



**WILDCAT TAPERED SEAT NUT**

The tapered seat nut is perfect for replacing rusted or broken lug nuts. Great for showing off your wheels and enhancing the overall look of your vehicle.

- Tapered wheel nut set.
- Set of four.
- In clam shell packaging.
- Available in other sizes.

PRODUCT CODE  
**94 B12-4 1/2 IN PK4**  
**94 B125-4 12 X 1.25MM PK4**  
**94 B15-4 12 X 1.5MM PK4**  
**94 B716-4 7/16 IN PK4**



## VEHICLE SAFETY

- Dash Cams .....242
- Reverse Cameras .....243
- Camera Wiring .....247
- UHF CB Radios.....248
- CB Earphones .....249
- Dash Cam Mini Battery .....249





**GATOR  
4K 16GB ULTRA HD DASH CAM  
WIFI GPS**

Capture 4K ultra-high definition, wide-angle videos with Gator's newest offering: The dual-channel G4KDVR20. Armed with a 2.7-inch high-resolution LCD touch screen display, G4KDVR20's recorded files and settings can quickly be accessed with just a few taps.

- 4K Ultra HD front & 720P HD rear camera for sharp, clear, crisp recordings.
- 160 Degree super wide angle lens captures a wide field of view to reduce blind spots and ensure an incident is never missed.
- Wide Dynamic Range video enhancement technology has better exposure range making videos look clearer.
- 2.7IN high resolution LCD touch screen that lets you access recordings and dash cam's settings with just a few taps.
- WiFi Connectivity enables wireless smartphone connection via the Gator Dash Cam App for video downloads and camera setting adjustments.
- GPS provides additional information by embedding speed and location data into the recordings.
- Super capacitor power supply that works in extreme temperatures, providing enough power to securely save the last recording when power gets disconnected.
- Built-in G-Sensor detects an impact and securely saves the video footage on the SD Card separate from the continuous loop files.
- Seamless cycle loop recording function continuously records in an indefinite loop without stopping, constantly overwriting the oldest file with the newest video.

PRODUCT CODE  
**76 G4KDVR20**



**GATOR  
720P 16GB HD DASH CAM**

A compact dash cam that records HD 720P at 30 frames per second with a wide 120 degree field of view. Features a 2in colour display that is great for instant video playback, adjusting camera settings and ensuring the camera is recording exactly where you want it.

- 720P High Definition @30FPS resolution to provide clear and crisp videos.
- 120 Degree wide angle lens captures a wide field of view to ensure an incident is never missed.
- 2IN High resolution display for instant video playback and dash cam setting adjustments.
- Built in G Sensor detects an impact and securely saves the video footage on the SD Card separate from the continuous loop files.
- Seamless cycle loop recording function continuously records in an indefinite loop without stopping, constantly overwriting the oldest file with the newest video.
- Manual SOS enables files to be securely saved with a push of a button.
- The included adhesive mount simply sticks to any windscreen and the included 12/24 volt compatible power cable simply connects to the vehicles accessory socket.
- Includes 16GB Micro SD Card, supports up to 32GB.

PRODUCT CODE  
**76 GDVR250**



**GATOR  
16GB 1080P FULL HD DASH CAM  
WITH WIFI/GPS**

The GHDVR85W brings together a dash cam, along with a GPS antenna, high spec 16GB micro SD card, secure adhesive dash cam mount and accessory socket plug and play power lead; providing everything you need for exceptional protection.

- 1080P Full High Definition 30FPS front camera resolution produces clear and crisp videos.
- 152 Degree wide angle lens ensure an incident is never missed.
- WiFi Connectivity enables wireless smartphone connection via the Gator Dash Cam App for video downloads and camera setting adjustments.
- Hand Gesture Control enables images to be taken and videos to be saved by simply waving your hand under the dash cam.
- 270 Degree Camera Rotation so it can face inside the vehicle cabin and the recording will automatically flip the orientation.
- Super capacitor power supply works in extreme temperatures and provides enough power to securely save the last recording when power is disconnected.
- Seamless cycle loop recording function continuously records in an indefinite loop without stopping, constantly overwriting the oldest file with the newest video.
- Dual USB charger simply connects to the vehicles accessory socket, the dash cam can be powered off one port and you still have a spare port to charge other devices.
- Includes a 16GB Micro SD Card, supports up to 256GB.

PRODUCT CODE  
**76 GHDVR85W**



**GATOR  
FULL HD 1080P WIFI  
FRONT & REAR DASH CAM**

Brings together two cameras for front and rear recording, along with a GPS antenna, high spec 16GB micro SD card, secure adhesive mounts for both cameras and accessory socket plug and play power lead, providing everything you need for exceptional protection.

- 1080P Full High Definition 30FPS front & rear camera resolution to provide clear and crisp videos
- 145 Degree front and 120 Degree rear wide angle videos ensure an incident is never missed
- Comes with adhesive windscreen surface mounts with 270 Degree camera rotation front and 360 Degree camera rotation rear
- WiFi Connectivity enables wireless smartphone connection via the Gator Dash Cam App for video downloads and camera setting adjustments
- Hand Gesture Control enables images to be taken and videos to be saved by simply waving your hand under the dash cam
- Included GPS Antenna provides additional information by embedding speed and location data into the recordings
- Super capacitor power supply works in extreme temperatures and provides enough power to securely save the last recording when power is disconnected
- Dual USB charger simply connects to the vehicles accessory socket, the dash cam can be powered off one port and you still have a spare port to charge other devices

PRODUCT CODE  
**76 GHDVR95W**



**GATOR  
MICRO USB HARD WIRED CABLE -  
GHDVR72W 82W 92W & 95W**

Unlock the full potential of your compatible Gator Dash Cam by adding the Gator GHWCUSB2 Hard Wire Cable Kit to the installation.

- Compatible with Gator GHDVR72W, GHDVR82W, GHDVR92W and GHDVR95W Dash Cam Models.
- Enables access to advanced parking mode feature on the compatible dash cams.
- 12/24 Volt compatible, suitable for virtually any vehicle.
- Frees up your vehicle's power socket.
- Allows for a discreet and professional installation.
- Voltage cut off ensures your vehicle battery will not drain.

PRODUCT CODE  
**76 GHWCUSB2**



**GATOR  
OEM STYLE MIRROR  
WITH 4.3IN MONITOR**

This rear view mirror monitor has a built-in 4.3in screen that gets you a visual of what's behind the vehicle when connected to a reverse camera and reverse gear engaged. It has the ability to add a reverse camera and front view camera.

- 4.3in LCD monitor with picture brightness adjustment
- OEM look and quality
- Special anti-glare glass
- Dual video inputs
- Auto switch to rear view when reversing

PRODUCT CODE  
**76 GRM430EM**



**GATOR**  
**4.3IN MIRROR MOUNT DISPLAY**  
**REVERSE CAMERA KIT**

Great for drivers or car owners seeking to get a reverse camera system because this kit not only makes reverse parking easy, but also helps increase road safety as drivers get a clear view of where they're reversing.

- Provides clear rear view of the vehicle for safe reverse parking.
- Simple DIY wired installation.
- 7in commercial grade display with angle adjustable metal mounting bracket.
- Includes two cameras, a stealth-mount registration plate reverse camera for the vehicle and a heavy duty reverse camera for the trailer.
- Triple video camera input-enabled allowing additional cameras to be added to the system.
- High/low voltage cut off and built in circuit protection.
- PROLINK II screw connection cables for reliable dustproof and waterproof connections.
- Easy connect/disconnect trailer connection plugs and curly cable.
- 12 & 24V Compatible suitable for light commercial vehicles, 4wds and cars.

PRODUCT CODE  
**76 GRV43MKT**



**GATOR**  
**9IN 1080P HD**  
**HI-RES MIRROR MONITOR**  
**WITH REVERSE CAMERA**

GRV90MKT provides the ultimate surveillance and protection for the rear of your vehicle. Featuring a super wide 9in high resolution touch display and HD 1080P camera, the mirror monitor simply clips over the existing rear view mirror on the vehicle for convenient unobtrusive viewing.

- 9in high resolution super wide LCD touch screen mirror monitor.
- 1080P High definition camera with video recording at 30 fps for clear crisp recordings (optional micro SD card required, sold separately).
- Rubber clip-on mirror mount for simple and secure installation, suitable for all vehicles with a rear-view mirror.
- 110-degree wide angle camera lens reduces blind spots at the rear of the vehicle.
- Automatic reverse trigger displays reverse image and parking gridlines when reverse gear is engaged to assist with reverse parking.
- Live streaming function enables the monitor to display rear vision while driving, ideal for vehicles with limited rear vision.
- Built in G-Sensor detects an impact and securely saves the video footage on the micro SD Card separate from the continuous loop files.
- Seamless cycle loop recording function continuously records in an indefinite loop without stopping, constantly overwriting the oldest file with the newest video.
- Support Micro SD card class 10 up to 64GB (sold separately).

PRODUCT CODE  
**76 GRV90MKT**



**GATOR**  
**7IN DASH MOUNT**  
**REVERSING CAMERA KIT**

GT700SD comes with a 7in heavy duty display monitor with adjustable metal mounting bracket, battery-operated IR remote control, small footprint heavy duty camera, removable sunshade for the display and a 6-metre input harness.

- Provides unobstructed rear view of the vehicle for safer reversing and peace of mind
- 7in commercial grade display with angle adjustable metal mounting bracket
- Small footprint commercial grade reverse camera with 10 IR LEDs for night vision
- Triple video camera input-enabled allowing additional cameras to be added to the system
- Rated IP69K dust and waterproof camera that withstands harsh environment condition
- High/low voltage cut off and built in circuit protection
- PROLINK II screw connection cables for reliable dustproof and waterproof connections
- 12 & 24V Compatible suitable for commercial vehicles, 4-wheel drives and cars
- Easy wired installation for DIY enthusiasts

PRODUCT CODE  
**76 GT700SD**



**GATOR**  
**7IN DASH MOUNT DISPLAY**  
**DUAL REVERSE CAMERA TRAILER KIT**

GT700SDTK is a commercial grade complete reverse camera solution for towing a caravan, trailer or horse float, as it comes supplied with two cameras, one for the vehicle and one for the trailer, as well as trailer connection and extension cables.

- Great reverse camera solution for vehicles that tow trailers, caravans and horse floats.
- Provides clear rear view of the vehicle for safe reverse parking.
- 7in commercial grade display with angle adjustable metal mounting bracket.
- Includes two cameras, a stealth-mount registration plate reverse camera for the vehicle and a heavy duty reverse camera for the trailer.
- Triple video camera input-enabled allowing additional cameras to be added to the system.
- High/low voltage cut off and built in circuit protection.
- PROLINK II screw connection cables for reliable dustproof and waterproof connections.
- Easy connect/disconnect trailer connection plugs and curly cable.
- 12 & 24V Compatible suitable for light commercial vehicles, 4wds and cars.

PRODUCT CODE  
**76 GT700SDTK**



**GATOR**  
**4.3IN DASH MOUNT DISPLAY**  
**REVERSE CAMERA KIT**

Built with a high-brightness and high-resolution 4.3in display and an adjustable mount, Gator GRV43KT wired reverse camera kit is ideal for almost any vehicle types. It sports easy to use picture adjustment buttons conveniently situated on the rear-most part of the monitor.

- Provides unobstructed rear view of the vehicle for safer reversing and peace of mind
- 4.3in high resolution colour display for a clear, easy to view image
- 500CD high brightness display with adjustable picture settings making it easy to view day and night
- Adjustable adhesive display mount suitable for mounting on the vehicles dashboard
- Butterfly mount reverse camera design for discreet and simple installation
- Dual video camera input-enabled allowing an additional camera to be added to the system
- Rated IP67 dust and waterproof camera that withstands harsh environment conditions.
- 170 Degree wide angle lens to eliminate blind spots
- Easy wired installation for DIY enthusiasts

PRODUCT CODE  
**76 GRV43KT**



**GATOR**  
**5IN DASH MOUNT**  
**REVERSING CAMERA KIT**

Built with a high-brightness and high-resolution 5in display with an adjustable adhesive mount, Gator GRV50KT wired reverse camera kit is ideal for almost any vehicle type. It sports easy to use picture adjustment buttons conveniently situated on the rear-most part of the monitor.

- Provides unobstructed rear view of the vehicle for safer reversing and peace of mind
- 5in high resolution colour display for a clear, easy to view image
- 500CD high brightness display with adjustable picture settings making it easy to view day and night
- Adjustable adhesive display mount suitable for mounting on the vehicles dashboard
- Butterfly mount reverse camera design for discreet and simple installation
- Dual video camera input-enabled allowing an additional camera to be added to the system
- Rated IP67 dust and waterproof camera that withstands harsh environment conditions.
- 170 Degree wide angle lens to eliminate blind spots
- Easy wired installation for DIY enthusiasts

PRODUCT CODE  
**76 GRV50KT**



**GATOR SURFACE MOUNT HEAVY DUTY CAMERA WITH LOOP SYSTEM**

From Gator GT Series wide range of enhanced vision systems comes the GT50L, a heavy duty camera housed in a surface mount with U-shaped bracket ideal for heavy trucks, mining loaders and other industrial or construction vehicles.

- Heavy duty surface mount design with U-shaped bracket for simple installation on a machine or vehicle.
- 120 degree wide angle lens for reduced blind-spots.
- Aluminium case and rated IP68 that guarantee the camera will withstand impact of water and debris normally hounding the vehicle's exterior.
- 10 Infrared LEDs built in for superior night vision.
- Adjustable sunshade and PROLINK II to RCA adaptor included.
- Loop system for adjustable settings during installation.
- 3 year warranty for peace of mind.

PRODUCT CODE  
**76 GT50L**



**GATOR STEALTH REGISTRATION PLATE MOUNT CAMERA WITH LOOP SYSTEM**

The Gator stealth registration plate reverse camera is compact and should mount behind any standard size registration plate. It suits vehicles with a centrally mounted registration plate in for the best viewing angle.

- Equipped with optional parking gridlines that help you reverse the vehicle with ease even in tight parking spots
- Can be used as a front view, rear view or reverse camera thanks to the loop feature
- Low lux image sensor for use in low light environments
- CMOS camera with number plate mount.
- 120/60 Degree viewing angle.
- Waterproof IP67.
- Includes 1.5-metre power wire and 5.5-metre RCA lead

PRODUCT CODE  
**76 G45CL**



**GATOR BUTTERFLY MOUNT CAMERA WITH LOOP SYSTEM**

Ideal for anyone looking for a high quality camera, is a super compact one that mounts virtually anywhere on the front or rear of the vehicle. Comes with optional built-in parking gridlines that helps guide you when reverse parking.

- Surface mount design for simple installation on the front or rear of the vehicle
- Can be used as a front view, rear view or reverse camera thanks to the loop feature
- Equipped with optional parking gridlines that help you reverse the vehicle with ease even in tight parking spots
- 170 degree super wide angle lens for reduced rear view blind spots
- Aluminum case and rated IP67 that guarantee the camera will withstand impact of water and debris normally hounding the vehicle's exterior
- Camera is PAL/NTSC switchable, making it compatible with all display monitors and aftermarket AV headunits with RCA input
- Low lux image sensor for use in low light environments
- Includes 1.5-metre power wire and 6-metre RCA lead
- Loop system for adjustable settings during installation

PRODUCT CODE  
**76 G30CL**



**GATOR DYNAMIC GUIDELINE REVERSE CAMERA**

The durable camera is IP67 rated to ensure it will withstand the harsh conditions and it has a wide 120 degree camera angle providing exceptional coverage at the rear of the vehicle.

- Dynamic moving guidelines move when the vehicle moves, predicting the path of the vehicle.
- 120 degree wide angle lens provides exceptional rear coverage.
- Universal butterfly mounting system allows for installation at the rear on any vehicle.
- IP67 Waterproof/Dustproof will ensure the camera will withstand the harsh Australian environment.
- Advanced movement detection technology means the camera does not need to be connected to CANBUS or OBD2 in the vehicle.
- Compatible with all 12V vehicles.
- Compatible with PAL display monitors.
- 5.8M RCA video lead and 1.5M camera lead provides a total cable length of 7.3M.
- Mini din connection at camera for simple installation.

PRODUCT CODE  
**76 G30DL**



**GATOR SURFACE MOUNT CAMERA WITH LOOP SYSTEM**

Gator G55CL, ideal for anyone looking for a high quality camera, is a super compact one that mounts virtually anywhere on the front or rear of the vehicle. Comes with optional built-in parking gridlines that helps guide you when reverse parking.

- Surface mount design for simple installation on the front or rear of the vehicle
- Can be used as a front view, rear view or reverse camera thanks to the loop feature
- Equipped with optional parking gridlines that help you reverse the vehicle with ease even in tight parking spots
- 170 degree super wide angle lens for reduced rear view blind spots
- Aluminum case and rated IP67 that guarantee the camera will withstand impact of water and debris normally hounding the vehicle's exterior
- Camera is PAL/NTSC switchable, making it compatible with all display monitors and aftermarket AV headunits with RCA input
- Low lux image sensor for use in low light environments
- Includes 2-metre power wire and 6-metre RCA lead
- Loop system for adjustable settings during installation

PRODUCT CODE  
**76 G55CL**



**GATOR CAMERA CABLE EXTENSION 3M**

The Gator 4 pin Prolink 3m extension cable is a 3m extension cable designed to suit Gator Prolink camera systems.

- Length: 3m.

PRODUCT CODE  
**76 PLC3**



**GATOR SURFACE MOUNT HEAVY DUTY CAMERA**

From Gator wide range of enhanced vision systems comes a heavy duty surface mount camera with U-shaped bracket ideal for heavy trucks, mining loaders and other industrial or construction vehicles.

- Heavy duty surface mount design with U-shaped bracket for simple installation on a machine or vehicle,
- 120 degree wide angle lens for reduced blind spots.
- Aluminium case and rated IP68 that guarantee the camera will withstand impact of water and debris normally hounding the vehicle's exterior.
- 10 Infrared LEDs built in for superior night vision.
- Adjustable sunshade and PROLINK II connector included.
- 3-Year Warranty.

PRODUCT CODE  
**76 GT14SD**



**GATOR MINI USB DASH CAMERA HARD WIRE KIT**

Gator Hard Wire Kit GHWC connects the genuine Gator dash cam directly to an accessory circuit in the vehicle's fuse box, enabling a professional installation of the dash cam across the board, instead of solely relying on the power coming from the accessory socket.

- Hard wires Gator dash cams to the vehicle accessory power
- Suitable for Gator dash cams with mini USB power input
- 12V and 24V compatible
- Provided with 2-metre USB cable
- Comes with a 0.5-metre power cable

PRODUCT CODE  
**76 GHWC**



**GATOR SURFACE MOUNT HEAVY DUTY CAMERA**

From Gator GT Series wide range of enhanced vision systems comes the GT16SD, a heavy duty surface mount camera with U-shaped bracket ideal for heavy trucks, mining loaders and other industrial or construction vehicles.

- Heavy duty surface mount design with U-shaped bracket for simple installation on a machine or vehicle.
- 120 degree wide angle lens for reduced blind spots.
- Aluminium case and rated IP69K that guarantee the camera will withstand impact of water and debris normally hounding the vehicle's exterior.
- 18 Infrared LEDs built in for superior night vision.
- Adjustable sunshade and PROLINK II connector included.
- 3-Year Warranty for peace of mind.

PRODUCT CODE  
**76 GT16SD**

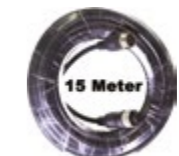

**GATOR CAMERA CABLE EXTENSION 15M**

Gator PLC15 is a 15-metre 4 Pin PROLINK II extension cable designed to suit Gator PROLINK II camera systems. The cable is ideal for use on long vehicles such as utes, 4wd's and trucks.

- 4 Pin PROLINK II cable compatible with Gator PROLINK II camera systems
- 15-metre long ideal for extending existing cables on long vehicles
- Heavy duty cable for commercial applications

PRODUCT CODE  
**76 PLC15**



**CRYSTAL  
5W COMPACT IN CAR UHF  
CB RADIO**

The CB radio provides you with a reliable, clear and efficient communications service which is enhanced by an ergonomic design and intuitive user controls. Inherently reliable you can depend on your radio no matter where you are in the harsh environment.

- 80 narrow band channels.
- Large multicolour display (7 colours).
- 5 watt transmission power.
- Duplex (range extender).
- Car stereo mute out feature.

PRODUCT CODE  
**76 DB477A**



**CRYSTAL  
5W SUPER COMPACT IN CAR UHF  
CB RADIO**

The unit features an aluminium die cast chassis, 80 narrow band channels, easy to read display and all the other features you would expect from a UHF. It's super compact size along with universal mounting bracket allows for easy installation in almost any vehicle.

- 5 Watt transmission power
- 80 Narrow band channels
- Duplex (Range extender)
- Dual channel monitor
- Mute out (Capable of muting car stereo when receiving)
- Backlit display
- Full aluminum die cast chassis
- Channel scan
- Automatic squelch control

PRODUCT CODE  
**76 DB477E**



**CRYSTAL  
HANDHELD UHF CB RADIO SET  
0.3 WATT**

The handheld CB radio with 80 narrow band channels and back lit display, comes in a set of two. With a range of up to 4km radius on perfect terrain and atmospheric conditions, these radios are suitable for light outdoor use.

- Range up to 3km
- 80 Narrow band channels.
- 0.3 Watt transmission power
- Duplex (range extender)
- Uses 3 x AAA batteries per unit (not included).

PRODUCT CODE  
**76 DBH03**



**CRYSTAL  
1W HANDHELD UHF CB RADIO  
TWIN PACK**

The Crystal Mobile DBH11R rechargeable 1W handheld UHF CB radios are ideal for work sites, events, families at the campsite or even vehicles on a convoy.

- Comes supplied with rechargeable batteries and a desktop charging dock
- 2x Belt Clip
- 1x 240V AC Adapter

PRODUCT CODE  
**76 DBH11R**



**CRYSTAL  
5W HANDHELD UHF  
CB RADIO TWIN PACK**

The Crystal Mobile DBH50RKT twin pack contains 2x DBH50R 5W handheld UHF CB radios, ideal for professional use and the serious off roader.

- 2 x DBH50R 5W Handheld UHF CB Radios with aluminium die cast chassis and Rechargeable Li-ion battery.
- 2 x base chargers, 2 x car chargers.
- 2x belt clips.
- 2 x earpieces.
- Suitable for rugged outdoor use and professional applications.

PRODUCT CODE  
**76 DBH50RKT**



**CRYSTAL  
EARPHONE  
WITH MICROPHONE  
1 PAIR**

A pair (2 pieces) of earphone with microphone for the DBH series CB radios. Hands-free operation using VOX feature.

- Suits all Crystal M handhelds except for the DBH50R
- Light weight design

PRODUCT CODE  
**76 DBH2EM**



**THINKWARE  
IVOLT MINI EXTERNAL BATTERY**

This battery pack charges while the vehicle is driving and powers your dash cam during parking mode instead of drawing current from the vehicle's battery. It will only work with hardwired dash cams, and it simply hardwires to the vehicle's battery or fusebox.

- High capacity 4500mAh LiFePo4 battery
- Up to 20 hours for 1-channel dashboard camera (forward-facing camera only) (2.9Wh)
- Up to 16 hours for 2-channel dashboard camera (front-facing and rear-facing camera) (3.5Wh)
- Approximately 50 minute charge time
- Fuse taps for easy wiring into fuse box
- Output harness supplies Constant, Accessories and Earth to device
- Korean Made Reliability with 1-Year Warranty

PRODUCT CODE  
**76 IVOLTMN**



## ELECTRICAL

Interior LED Lighting Kits .....	252
Exterior LED Lighting Kits.....	254
LED Strip Extension Cables.....	256
Multi-Colour LED Extension Strips.....	257
Multi-Colour Dome Light.....	258
Interior LED Strip Lights .....	259
Driving Lights.....	261
Light Bars .....	262
Narva Product Catalogue Link.....	264
Lamps.....	266
Booster Cables .....	267
Cable Ties.....	268
Electrical Tape .....	272
Grommets.....	273
Cable Glands.....	273
Cable Joiners.....	273
Power Meter .....	274
DC Power Link .....	275
50A Connector Accessories .....	278
Trailer Plugs & Sockets.....	280
Portable Battery Box & Voltmeter .....	282
Intelligent Jumper Leads .....	283
Cable Crimpers.....	284
Cable Tie Guns .....	284
Distilled Water .....	285



**TYPE S  
72IN SMART LED  
INTERIOR TRIM  
LIGHTING KIT**

Since the TYPE S interior lighting kit has multiple colour combinations, you can precisely customize your personal LED smart trim lighting kit. Whether you want lights around your dashboard, cupholder, or somewhere else in your vehicle, installation is a breeze.

- Personalize your lighting experience with the TYPE S LED App.
- Select from 49 colours and 8 effect modes.
- Control brightness and speed of effect modes.
- Personalize your exterior lighting effects with a custom touch.

PRODUCT CODE  
**63 LM55879**



**TYPE S  
24IN SMART LED  
PLUG & GLOW  
STARTER KIT**

The TYPE S 24in Smart LED kit features 2 feet of wirelessly controlled LED lights that you can mount just about anywhere in your vehicle. You can change the colour of the LED lights to adjust your car's interior to fit your mood.

- Personalize your lighting experience with the TYPE S LED App.
- Select from 49 colours and 8 effect modes.
- Control brightness and speed of effect modes.
- Includes 12V adapter plug and hardwire power options.
- Enjoy the choice of which light turns on in designated colour zones.
- The brightest LED lighting accents for your customized design. Get 6% brighter than standard LEDs with HyperBright.
- Working Voltage: DC 12V.

PRODUCT CODE  
**63 LM55252M**



**TYPE S  
48IN SMART LED  
PLUG & GLOW  
DELUXE LIGHTING KIT**

Looking to add some unique colours to your vehicle's interior? Look no further than the TYPE S App-Controlled 48in Smart LED Deluxe Lighting Kit. This kit uses easy-to-install LED light strips to allow you to transform your vehicle into a fun and creative escape.

- Personalize your lighting experience with the TYPE S LED App.
- Select from 49 colours and 8 effect modes.
- Control brightness and speed of effect modes.
- Includes 12V adapter plug and hardwire power options.
- Enjoy the choice of which light turns on in designated colour zones.
- The brightest LED lighting accents for your customized design. Get 6% brighter than standard LEDs with HyperBright.
- Working Voltage: DC 12V.

PRODUCT CODE  
**63 LM55369M**



**TYPE S  
4 PIECE SMART PLUG & GLOW  
MICRO LIGHT KIT**

Looking to add some unique colours to your vehicle's interior? Look no further than the TYPE S App-Controlled Micro Lights LED Lighting Kit. This kit uses easy-to-install LED Micro lights to allow you to transform your vehicle into a fun and creative escape.

- Great for cars, trucks, SUV's, RV's and motorcycles.
- Free TYPE S LED app that works with most iPhone and Android devices.
- Customize up to 4 different zones of LED lighting for your vehicle using 49 different colours and 23 unique modes.
- Operating Voltage: 12 VDC System Only.
- Bluetooth / App Distance: 30ft LOS (Line of Sight).
- Maximum Amperage Draw: 3A.

PRODUCT CODE  
**63 LM55391**





**TYPE S  
120IN SMART LED  
EXTERIOR TRIM LIGHTING KIT**

The TYPE S App-Controlled 120in Smart Exterior Trim Lighting Kit comes with colour-changing LED lights and an easy-to-use app. You can install it along your grill, bumper, lift, gate, or panel gaps.

- Personalize your lighting experience with the TYPE S LED App.
- Select from 49 colours and 6 effect modes.
- Weatherproof design.
- Flexible material mounts with 3M tape.0

PRODUCT CODE  
**63 LM57485**



**TYPE S  
120IN SMART EXTERIOR  
TRUCK BED LED**

Changing the batteries on exterior truck bed lights can be a pain. To make things easier, look for long-lasting batteries and durable bulbs when you're considering your options. With added lighting, you can turn your truck bed from typical to stylish.

- Smart Hub Controller for a custom lighting experience using the TYPE S LED app.
- 49 unique colours, 8 light modes, and multi-zone presets for the ultimate exterior look.
- Set the mood outside your vehicle with 4 different light modes: Spot Light, Colour Light, Spot & Colour Light, and Strobe Light.
- Weatherproof design to keep your vehicle safely glowing down the road.

PRODUCT CODE  
**63 LM56245M**



**TYPE S  
72IN SMART LED  
EXTERIOR LIGHTING KIT**

If you're wondering what the best exterior 72in smart lighting kit for cars is and how to install one on your own, check out the kit from TYPE S. All you have to do is secure the LED strips on the outer edges underneath your vehicle and then extend the wires up to your engine bay.

- Personalize your lighting experience with the TYPE S LED App.
- Select from 49 colours and 8 effect modes.
- Control brightness and speed of effect modes.
- Curate a custom vehicle lighting experience from the palm of your hand.
- Take control of your exterior lighting and personalize your ride from the outside.

PRODUCT CODE  
**63 LM55878**



**TYPE S  
EXTERIOR  
TRUCK CAB LED LIGHT**

The Cab LED Light is a high-powered white LED. It will enhance visibility at night, early in the morning, or in poor weather conditions.

PRODUCT CODE  
**63 LM56615**

ELECTRICAL 254

ELECTRICAL 255



**TYPE S  
PLUG & GLOW  
SPLITTER & EXTENSION  
CABLE KIT**

Allows for endless customization options.

- Compatible with all TYPE S Plug & Glow LED products.
- Split, bend or extend lighting for custom installations.
- Includes 2 x 10 in extension cables and 3 splitters.

PRODUCT CODE  
**63 LM54893**



**TYPE S  
24IN SMART PLUG & GLOW EXTENSION CABLE**

Quickly and easily extend the distance of your TYPE S Plug & Glow LED lighting strips with this 4 pack extension wire pack.

- Compatible with TYPE S Plug and Glow lighting strips.
- Each extension cable is 24 inches.
- Includes 4 extension cables.

PRODUCT CODE  
**63 AC55392**



**TYPE S  
72IN MULTI-COLOUR LED  
INTERIOR TRIM  
LIGHTING EXTENSION STRIP**

TYPE S LED Extension Trim Lights can be added to any Smart Lighting Hub Controller. Apply Trim Lights almost anywhere by inserting between two panels - creating a subtle glowing accent light. Ideal for cars, boats, trucks and SUV's.

- Add another 6 feet to your existing TYPE S Smart LED Interior Trim setup with 72" LED extension strips.
- Smart control your lighting with the TYPE S LED app, featuring 49 unique colours, 8 light modes, and multi-zone presets for the ultimate interior look.
- With cut marks located on each LED strip, you can customize the fit for each application.
- Customized presets & zones .
- Trim-to-fit LED strips are water-resistant and backed with 3M VHB adhesive tape for secure mounting.

PRODUCT CODE  
**63 LM55880**



**TYPE S  
PLUG & GLOW  
HYPERBRIGHT 24\"/>**

TYPE S LED Extension Pack Light Strip can be added to any matching TYPE S LED Kit with Instant Plug & Glow® and extended up to 12ft. They can be applied almost anywhere and are great for cars, boat, trucks, SUV's, RV's and motorcycles.

- Trim to fit for customized installation .
- LED strip is protected with a clear, flexible, water-resistant diffuser.
- Strips backed with adhesive tape.
- Unique Plug & Glow 4-pin design allows strips to be extended up to 12 ft .
- (Additional extension accessories sold separately).

PRODUCT CODE  
**63 LM55323**

ELECTRICAL 256

ELECTRICAL 257



**TYPE S  
SMART LED  
MULTICOLOUR SPOT LIGHT EXTENSION KIT  
4 PACK**

TYPE S LED Extension Micro Lights can be added to any Smart Lighting Hub Controller. Extended up to 72 lights (total combined). They can be applied almost anywhere and are great for cars, boats, trucks, SUV's, RV's and motorcycles.

- KIT CONTAINS:
- 4 x Multi-Colour Micro LED Light.
- 4 x 24" Extension Cable.

PRODUCT CODE  
**63 LM55259**

**TYPE S  
SMART MULTI-COLOUR  
DOME LIGHT**

A good dome light is a good look for your car. It brightens the interior, provides a sense of cohesion, and lets you feel more confident in the overall image that you and your car present to the world.

- Smart Multi-Colour Dome Light.
- Personalize your lighting experience with the TYPE S LED App.
- Select from 49 unique colours, eight light modes and multi-zone presets.
- Universal dome light adaptor.

PRODUCT CODE  
**63 LM55258**



**AERPRO  
LED FLEXIBLE STRIP  
12V 8MM X 1M  
60 SUPER BRIGHT BLUE LEDS**

Brighten up your interior with our easy to install LED strip tape. They are easy to install/remove - can be easily trimmed to the desired length and come in a wide range of colours.

- 1M roll contains 60 super bright LED's.
- Strip can be trimmed to the desired length.
- Strong self adhesive backing tape.
- 12V DC input.

PRODUCT CODE  
**63 SMD1000B**



**AERPRO  
5M FLEXIBLE  
MULTICOLOUR LED LIGHT STRIP ADHESIVE BACKING**

Highlight features around your home with the RGB LED lighting strip kit! The LED's have an epoxy coating to protect the tape from general wear and tear, as well as being easy to keep clean.

- Flexible RGB SMD LED strip lighting.
- Easy to install with 3M adhesive backing.
- Remote controlled multi-colour functionality.
- Dimmer and brightness control.
- 4 Light transitions (Flash, strobe, fade, smooth).
- 16 selectable colours.
- 240V adapter included.
- 5 metres long with 140 SMD LEDs.

PRODUCT CODE  
**63 SMD5MP**

# BIG RED™ GEAR PERFORMANCE LED LIGHTING



For Endless tracks, Endless sunsets, Endless memories  
**ENDLESS ADVENTURES**

## DRIVING LIGHTS

### 12/24V 9IN 150W 15000 LUMENS SINGLE LED DRIVING LIGHT

**Code: BR9032**



- Equipped with 30 high-output Osram LEDs.
- Two lights produce a beam throw of up to 921 metres at 1 lux.
- High output 5W Osram LEDs produce a crisp white light.
- Dimensions at 220mm (W), 240mm (H) and 120mm (D).
- In the box: BR9032 9" Inch BRG LED Driving Light x1, Big Red Gear Clear Cover, Stainless Steel Bolts, Nuts and Washers, Rubber Mounting Pad, Distribution Plate and 2 Position DT lead.

### 12/24V 7IN 90W 9000 LUMENS SINGLE LED DRIVING LIGHT

**Code: BR9022**



- Equipped with 18x high-output Osram LEDs.
- Two lights produce a throw of up to 702 metres at 1 lux.
- High output 5W Osram LEDs produce a crisp white light.
- Dimensions at 178mm (W), 194mm (H) and 108mm (D).
- In the box: BR9022 7" Inch BRG LED Driving Light x1, Big Red Gear Clear Cover, Stainless Steel Bolts, Nuts and Washers, Rubber Mounting Pad, Distribution Plate and 2 Position DT lead.

### 12/24V 5IN 45W 4500 LUMENS SINGLE LED DRIVING LIGHT

**Code: BR9012**



- Equipped with 9x high-output Osram LEDs.
- Two lights produce volumes of light with a spot beam of up to 507 metres at 1 lux.
- High output 5W Osram LEDs produce a crisp white light.
- Dimensions at 126mm (W), 143mm (H) and 100mm (D).
- In the box: BR9012 5" Inch BRG LED Driving Light x1, Big Red Gear Clear Cover, Stainless Steel Bolts, Nuts and Washers, Rubber Mounting Pad, Distribution Plate and 2 Position DT lead.

## ACCESSORIES



**SLIDING BRACKETS FOR  
SINGLE ROW LED  
LIGHT BARS**  
**Code: BR9190**



**PLUG AND PLAY  
WIRING HARNESS**  
**Code: BR9095**  
Includes HB3 and H4 adaptors for high beam circuit.  
DT waterproof connectors and fuse holder with 30A fuse.  
Suitable for 12V vehicles.



**SLIDING BRACKETS FOR  
DOUBLE ROW LED  
LIGHT BARS**  
**Code: BR9290**

## LIGHT BARS



**12/24V 40IN 9000 LUMENS LED LIGHT BAR**  
Code: BR9142

- High output 90W Osram LEDs produce a crisp, white light and unparalleled performance.
- Combination beam reflector for distance and spread of light. 1 lux at 656 metres.



**12/24V 22IN 6000 LUMENS DOUBLE ROW LED LIGHT BAR**  
Code: BR9222

- High output 60W Osram LEDs produce a crisp, white light and unparalleled performance.
- Spot beam reflector for distance and spread of light. 1 lux at 350 metres.



**12/24V 20IN 4500 LUMENS LED LIGHT BAR**  
Code: BR9122

- High output 45W Osram LEDs produce a crisp, white light and unparalleled performance.
- Combination beam reflector for distance and spread of light. 1 lux at 410 metres.



**12/24V 10IN 1800 LUMENS LED LIGHT BAR**  
Code: BR9112

- High output 18W Osram LEDs produce a crisp, white light and unparalleled performance.
- Spot beam reflector for distance and spread of light. 1 lux at 350 metres.



## KEY FEATURES

### DRIVING LIGHTS



5700°K colour temperature LEDs.

Each lamp includes a clear see-through polycarbonate cover for protection from stone spray and debris.



Tested and complied to ECE R10 for Electro Magnetic Compatibility (EMC).

Heavy duty stainless steel brackets. Rubber dampening system.

Fully sealed and tested to IP68. Dust and water resistant.



3mm thick virtually unbreakable, scratch resistance polycarbonate lens.

Multi-voltage input suitable for both 12 and 24V vehicles.

### LIGHT BARS



5700°K colour temperature LED's.

Low profile side mounting brackets.

Tough aluminium housing and polycarbonate lens.



Tested and complied to ECE R10 for Electro Magnetic Compatibility (EMC).

Black stealth slimline design.



Fully sealed and tested to IP67.

Multi-voltage input suitable for both 12 and 24V vehicles.

Dust and water resistant.

# NARVA®

THE VISION TO GO FURTHER



## AUTOMOTIVE LIGHTING & ELECTRICAL



We stock the full and comprehensive range of Narva products.  
Ask for a catalogue or visit [www.narva.co.nz](http://www.narva.co.nz)



**MAXILITE  
12/24V CLASS 1  
LED STROBE LOW PROFILE AMBER**

Seven selectable flash patterns including slow or fast rotation, 4 strobe/flash and solid state functions the Maxilite Ultraslim beacons will meet the requirements for any transport, commercial or construction vehicles on the road or building site.

- Amber LED
- SAE Class 1 beacon.
- Low profile 48mm high.
- Easy mount base.
- IP67 waterproof.
- Bright light output.
- 7 flash patterns.

PRODUCT CODE  
**MX1000**



**MAXILITE  
MAXILITE 12V LED  
REAR COMBO LAMP KIT**

The product acts as a LED marker light, auto side lamps, clearance light, identification light or a trailer light and can be used as a combination clearance light/side marker if properly mounted. The product has slim line lamps with inbuilt reflectors.

- Tinned cable and stainless steel fittings.
- Fully sealed with 40cm hard wired cable.
- ADR approved with a 3 year L.E.D warranty.
- Also available in a bulk pack of 10 units.

PRODUCT CODE  
**MX100BL2**



**MAXILITE  
LED REAR COMBO KIT  
12V WITH LICENSE PLATE**

Box trailer? Semi-trailer? Heavy rigid? No matter the vehicle size or shape, Maxilite is certain to have a suitable rear connection lamp for your application.

- Slim line lamps with licence plate lamp.
- Tinned cable and stainless steel fittings.
- ADR approved with a 3 year L.E.D warranty.
- Fully sealed with 40cm hard wired cable.

PRODUCT CODE  
**MX102BL2**



**MAXILITE  
10-30V LED  
REOM RED**

The product functions as led marker light, auto side lamps, clearance light, identification light, trailer Light etc. Can be used as a combination clearance and side marker if properly mounted. The product comes with a black mounting base.

- 10-30V multi-voltage circuitry.
- Fully sealed with 40cm hard wired cable.
- ADR approved with a 3 year L.E.D warranty.
- Also available in a bulk pack of 10 units.
- Colour: Red.

PRODUCT CODE  
**MX583BL**



**MAXILITE  
10-30V LED  
SQUARE WORK LAMP**

- 10-30V multi-voltage circuitry.
- Fully sealed (IP68) with 40cm hard wired cable.
- Includes stainless steel mounting hardware.
- Aluminium housing with polycarbonate lens.
- 800 Lumens with a 2 year L.E.D warranty.

PRODUCT CODE  
**MX900**



**MAXILITE  
10-30V LED  
ROUND WORK LAMP**

The product has superior-quality LED chips and a super bright ray to light up the forward dark road. Flood beam provides a much larger spread of light for broad view area, clear visible surrounding.

- 10-30V multi-voltage circuitry.
- Fully sealed with 40cm hard wired cable.
- Includes stainless steel mounting hardware.
- Aluminium housing with polycarbonate lens.
- 950 Lumens with a 2 year L.E.D warranty.

PRODUCT CODE  
**MX902**



**MAXILITE  
MAXILITE 12V LED  
REAR COMBO LAMP KIT**

The product functions as led marker light, auto side lamps, clearance light, identification light, trailer Light etc. Can be used as a combination clearance and side marker if properly mounted. The product has slim line lamps with inbuilt reflectors.

- Tinned cable and stainless steel fittings.
- Fully sealed with 40cm hard wired cable.
- ADR approved with a 3 year L.E.D warranty.
- Also available in a bulk pack of 10 units.

PRODUCT CODE  
**MX150BL2**



**MAXILITE  
LED REAR COMBO KIT  
12V WITH LICENSE PLATE**

The product functions as led marker light, auto side lamps, clearance light, identification light, trailer Light etc. Can be used as a combination clearance and side marker if properly mounted. The product has slim line lamps with licence plate lamp.

- Tinned cable and stainless steel fittings.
- Fully sealed with 40cm hard wired cable.
- ADR approved with a 3 year L.E.D warranty.

PRODUCT CODE  
**MX152BL2**



**MAXILITE  
10-30V REAR COMBINATION LAMP  
280X100MM**

Made from tough polycarbonate, pre-wired with 500mm of cable, low current draw, a LED lifespan of 100,000 hours, ADR Approved and IP67 Waterproof, the Maxilite MX160 LED Tail Lamps will suit any truck, truck trailer or caravan application.

PRODUCT CODE  
**MX160**



**AC PRO  
BOOSTER CABLE  
200AMP**

A must have for your emergency kit in the car, Suitable for 4 and 6 cylinder vehicles. The booster cable is surge protected and has insulated clamps thus making it safer than other cables.

- Suitable for 4 and 6 cylinder vehicles.
- Surge protected.
- 12/24V Vehicles.
- Insulated clamps.
- Length: 2.5m

PRODUCT CODE  
**BC200E 200AMP  
BC400E 400AMP**



**AC PRO  
BOOST CABLES  
AC PRO 50MM SQ 3.7M**

These booster cables are used jumpstart your car. The booster cables have the feature of surge protection which reduces the risks of voltage spikes during jump starting and protects sensitive on-board electronics. These booster cables are suitable for commercial vehicles.

- Surge protected.
- 12/24V vehicles.
- Fully insulated clamps.
- 3.7m long.

PRODUCT CODE  
**BC50MM**



KT Cable Accessories is the market leader in quality cable ties. Offering a vast range of colours, lengths and sizes, KT has quality ties wrapped up.

The range includes short, long, black, natural, coloured (red, blue, green, yellow, purple, orange, and pink), identification, releasable, stainless steel, mounting head, push-mount and wrap strapping. All black cable ties supplied by KT are UL approved nylon with 6/6 flammability rating of UL94V-2. KT cable ties are UV treated, weather resistant and durable with a standing reputation of quality within the industry.

Quantities range from as small as a 20 piece pack through to cartons of 100, 1000's and pallets. Cable tie tensioning tools are also available.

**KT  
CABLE TIES - LIGHT DUTY**

PRODUCT CODE	COLOUR	LENGTH (MM)	WIDTH (MM)	PACK QTY	CARTON QTY	LOOP TENSILE STRENGTH
KT1002525	Black	100	2.5	25	-	8.1kg / 18lbs
KT10025	Black	100	2.5	100	550	8.1kg / 18lbs
KT10025NT	Natural	100	2.5	100	550	8.1kg / 18lbs
KT20025	Black	200	2.5	100	300	8.1kg / 18lbs



**NOTE**  
We recommend the use of cable tie guns KTLDCTG, KTHDCTG/P or KTHDCTG/M for easy fastening. These can be found in the tools section of our catalogue.

**KT  
CABLE TIES - STANDARD DUTY**

PRODUCT CODE	COLOUR	LENGTH (MM)	WIDTH (MM)	PACK QTY	CARTON QTY	LOOP TENSILE STRENGTH
KT1523525	Black	150	3.6	25	-	18.2kg / 40lbs
KT15235	Black	150	3.6	100	300	18.2kg / 40lbs
KT15235NT	Natural	150	3.6	100	550	18.2kg / 40lbs
KT20035	Black	200	3.6	100	200	18.2kg / 40lbs
KT25036	Black	250	3.6	100	200	18.2kg / 40lbs
KT29236	Black	290	3.6	100	170	18.2kg / 40lbs



**NOTE**  
We recommend the use of cable tie guns KTLDCTG, KTHDCTG/P or KTHDCTG/M for easy fastening. These can be found in the tools section of our catalogue.

**KT  
CABLE TIES - MEDIUM DUTY**

PRODUCT CODE	COLOUR	LENGTH (MM)	WIDTH (MM)	PACK QTY	CARTON QTY	LOOP TENSILE STRENGTH
KT2024725	Black	200	4.8	25	-	22.2kg / 50lbs
KT20247	Black	200	4.8	100	160	22.2kg / 50lbs
KT20247NT	Natural	200	4.8	100	160	22.2kg / 50lbs
KT25048	Black	250	4.8	100	120	22.2kg / 50lbs
KT25048NT	Natural	250	4.8	100	120	22.2kg / 50lbs
KT3014825	Black	300	4.8	25	-	22.2kg / 50lbs
KT30148	Black	300	4.8	100	110	22.2kg / 50lbs
KT30148NT	Natural	300	4.8	100	110	22.2kg / 50lbs
KT3834825	Black	370	4.8	25	-	22.2kg / 50lbs
KT38348	Black	370	4.8	100	90	22.2kg / 50lbs
KT38348NT	Natural	370	4.8	100	90	22.2kg / 50lbs
KT43248	Black	430	4.8	100	75	22.2kg / 50lbs



**NOTE**  
We recommend you use cable tie guns KTLDCTG, KTHDCTG/P or KTHDCTG/M for easy fastening. These can be found in the tools section of our catalogue.

**KT  
CABLE TIES - HEAVY DUTY**

PRODUCT CODE	COLOUR	LENGTH (MM)	WIDTH (MM)	PACK QTY	CARTON QTY	LOOP TENSILE STRENGTH
KT20080	Black	200	7.6	100	60	54.4kg / 120lbs
KT30080	Black	300	7.6	100	50	54.4kg / 120lbs
KT3827525	Black	368	7.6	25	-	54.4kg / 120lbs
KT38275	Black	368	7.6	100	40	54.4kg / 120lbs
KT38275NT	Natural	368	7.6	100	40	54.4kg / 120lbs
KT43090	Black	480	9.0	100	25	79.4kg / 175lbs
KT5339025	Black	526	9.0	25	-	79.4kg / 175lbs
KT53390	Black	526	9.0	100	20	79.4kg / 175lbs
KT55013	Black	580	12.6	100	12	114kg / 250lbs
KT76290	Black	776	9.0	100	20	79.4kg / 175lbs
KT83090	Black	815	9.0	100	15	79.4kg / 175lbs
KT103013	Black	1030	12.6	100	10	114kg / 250lbs



**NOTE**  
We recommend you use cable tie guns KTHDCTG/9 or KTHDCTG/13 for easy fastening. These can be found in the tools section of our catalogue.

**KT  
CABLE TIES - MOUNTING HEAD**

PRODUCT CODE	COLOUR	LENGTH (MM)	WIDTH (MM)	PACK QTY	LOOP TENSILE STRENGTH	HOLE DIA (MM)
KTMH15535	Black	152	3.6	100	18.2kg / 40lbs	4.2
KTMH20546	Black	200	4.8	100	22.2kg / 50lbs	5.5



**NOTE**  
We recommend you use cable tie guns KTLDCTG, KTHDCTG/P, KTHDCTG/M. Mounting head cable ties can be screwed to a surface, then the tie can be used to bundle the cable or harness. These can be found in the tools section of our catalogue.

**KT  
CABLE TIES - PUSH MOUNT**

PRODUCT CODE	COLOUR	LENGTH (MM)	WIDTH (MM)	PACK QTY	LOOP TENSILE STRENGTH	HOLE DIA (MM)
KTPT155	Black	150	3.6	100	22.2kg / 50lbs	5.2
KTPT202	Black	200	4.8	100	22.2kg / 50lbs	6.3



**NOTE**  
Push mount cable ties are used once a hole is drilled. For example, in the firewall of a vehicle. The head of the tie can be pushed in, leaving the remaining tie to be bundled around cabling or harness.

**KT  
CABLE TIES - RELEASABLE**

PRODUCT CODE	COLOUR	LENGTH (MM)	WIDTH (MM)	PACK QTY	LOOP TENSILE STRENGTH
KTRT13076	Black	130	7.6	100	54.4kg / 50lbs
KTRT14035	Black	140	3.5	100	54.4kg / 50lbs
KTRT20247	Black	200	4.8	100	22.2kg / 50lbs
KTRT30048	Black	300	4.8	100	22.2kg / 50lbs



**NOTE**  
Releasable cable ties can be removed and reused.

ELECTRICAL 268

ELECTRICAL 269



**KT**  
**RED CABLE TIES - 150 X 3.5MM**

PRODUCT CODE	COLOUR	LENGTH (MM)	WIDTH (MM)	PACK QTY	LOOP TENSILE STRENGTH
KT15235R	Red	150	3.5	100	8.2kg / 40lbs



**KT**  
**RED CABLE TIES - 200 X 4.8MM**

PRODUCT CODE	COLOUR	LENGTH (MM)	WIDTH (MM)	PACK QTY	LOOP TENSILE STRENGTH
KT20247R	Red	200	4.8	100	22.2kg / 50lbs

**KT**  
**RED CABLE TIES - 300 X 4.8MM**

PRODUCT CODE	COLOUR	LENGTH (MM)	WIDTH (MM)	PACK QTY	LOOP TENSILE STRENGTH
KT30148R	Red	300	4.8	100	22.2kg / 50lbs

**KT**  
**1000 PIECE CABLE TIE PACK**

This cable tie assortment pack includes 1000 black cable ties of assorted sizes. The pack includes 10 packets of 100 cable ties. Sizes, quantities and pack quantities are listed below.

PRODUCT CODE	COLOUR	MATERIAL	SIZE (MM)	QTY PER PACK	NO. OF PACKS
KT10025	Black	Nylon	100 x 2.5	100	2
KT15235	Black	Nylon	152 x 3.5	100	2
KT20247	Black	Nylon	200 x 4.8	100	4
KT30148	Black	Nylon	300 x 4.8	100	2



PRODUCT CODE  
**KT1000**

**KT**  
**350 PIECE CABLE TIE PACK - COLOURED CABLE TIES**

COLOUR	MATERIAL	SIZE (MM)	QTY
Natural	Nylon	100 x 2.5	100
Blue (25), Green (25), Red (25), Yellow (25)	Nylon	100 x 2.5	100
Natural	Nylon	200 x 2.5	50
Black (25), Blue (25), Red (25), Yellow (25)	Nylon	200 x 2.5	100
Black (25), Blue (25), Red (25), Yellow (25)	Nylon	280 x 3.8	100



PRODUCT CODE  
**KT350C**

**KT**  
**MIXED COLOUR CABLE TIE BULK PACKS**

PRODUCT CODE	COLOURS	LENGTH (MM)	WIDTH (MM)	PACK QTY	LOOP TENSILE STRENGTH
KT15235MC	Blue (25), Green (25), Red (25), Yellow (25)	150	3.6	100	8.1kg / 18lbs
KT20247MC	Blue (25), Green (25), Red (25), Yellow (25)	200	4.8	100	22.2kg / 50lbs
KT30148MC	Blue (25), Green (25), Red (25), Yellow (25)	300	4.8	100	22.2kg / 50lbs
KT30148MX	Black (20), Natural (10), Blue (10), Green (10), Red (10), Yellow (10), Orange (10), Pink (10), Purple (10)	300	4.8	100	22.2kg / 50lbs



**KT**  
**REUSABLE HOOK & LOOP TIES**

PRODUCT CODE	COLOUR	LENGTH (MM)	WIDTH (MM)	PACK QTY
KTV20019/100	Black	200	19.0	100
KTV30025/75	Black	300	25.0	75



**KT**  
**SPLIT LOOM - BULK PACK**

PRODUCT CODE	COLOUR	BULK QTY	FITTING TYPE	SUITS LOOM SIZE (MM)
KT41000	Black	10	End Piece	7
KT41001	Black	10	End Piece	10
KT41002	Black	10	End Piece	13
KT41003	Black	10	End Piece	16
KT41010	Black	10	T-Piece	7
KT41015	Black	10	T-Piece	10
KT41020	Black	10	T-Piece	13
KT41050	Black	10	Y-Piece	7
KT41055	Black	10	Y-Piece	10
KT41060	Black	10	Y-Piece	13



**KT**  
**SPLIT LOOM TOOLS**

PRODUCT CODE	COLOUR	SPLIT LOOM TOOL SUITS
KT32001	Black	10-13 mm diameter split loom
KT32002	Black	16-20mm diameter split loom
KT32003	Black	23-36mm diameter split loom



**KT DUCTING & SEALING TAPE**

KT duct tape is made from plasticised PVC coated with rubber based, pressure sensitive adhesive. Available in silver & black 30m x 48mm rolls. Adhesion to steel is 40g / 25mm with 100% elongation.

PRODUCT CODE	COLOUR	LENGTH (M)	WIDTH (MM)	THICK (MM)	ADHESION TO STEEL	TENSILE STRENGTH	PACK QTY	CARTON QTY
KTDUCTB	Black	30	48	0.13	40g/25mm	5kg/25mm	1	80
KTDUCT	Silver	30	48	0.13	40g/25mm	5kg/25mm	1	80



**KT GAFFER TAPE**

KT gaffer tape uses a heavy cotton pressure-sensitive tape with strong adhesive and tensile properties. It is widely used in theatre, entertainment, music, film and television production industries due to its ability of being easily removed.

PRODUCT CODE	LENGTH (M)	WIDTH (MM)	PACK QTY	CARTON QTY
KTGAF	25	48	1	-



**KT AMALGAMATING TAPE**

Amalgamating tape is a non-tacky silicone-rubber tape which when stretched, wraps around cables, electrical joints, hoses and pipes to combine itself into a strong, seamless & waterproof insulated layer.

PRODUCT CODE	LENGTH (M)	WIDTH (MM)	PACK QTY	CARTON QTY
KTAMALG-5	5	19	1	-



**KT RESIN SOLDER**

PRODUCT CODE	TIN (%)	LEAD (%)	CORE	DIAMETER (MM)	WEIGHT (KG)
KTSOLR1.6	40	60	Resin	1.6	0.5
KTSOLR2.3	40	60	Resin	2.3	0.5
KTSOLR3.2	60	40	Resin	3.2	0.5



**KT CLOSED RUBBER GROMMETS**

PRODUCT CODE	PACK QTY	A (MM)	B (MM)	D (MM)	E (MM)
KTGMC0603S	10	8.5	6.3	4.7	1.7
KTGMC0705S	10	10.2	7.2	4.4	1.7
KTGMC1006S	5	13.3	10.6	6.3	1.7
KTGMC1410S	5	19.5	13.9	6.4	3.4
KTGMC2015S	3	23.7	20.1	6.1	1.7
KTGMC2518S	3	29.9	25.1	7.2	1.5

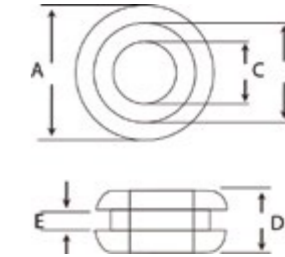

**KT NYLON CABLE GLANDS**

Cable glands are designed to protect cable as it passes through walls, cabinets or switchboards. The cable gland tightens around the wire to act as a seal. KT nylon cable glands are supplied complete with a lock nut and are tested and certified to IP68, in accordance with AS1939 - 1990. KT cable glands are suitable for indoor or outdoor use and suit a large cable range from 3mm - 44mm outside diameter.

PRODUCT CODE	DIAMETER (MM)	SUITS CABLE SIZE (MM)	PACK QTY
KTNCG12	12	3-6.5	100
KTNCG16	16	5-10	50
KTNCG20	20	10-14	35
KTNCG25	25	13-18	20
KTNCG32	32	18-25	12
KTNCG40	40	22-32	5
KTNCG50	50	30-38	3
KTNCG63	63	34-44	2



**KT WATERPROOF BUTT SPLICE JOINER**

PRODUCT CODE	COLOUR	PACK QTY	LENGTH (MM)	SUITS WIRE SIZE (MM <sup>2</sup> )
KT21510S	Red	5	2.8	1.5 - 2.5
KT21511S	Blue	5	4.8	2.5 - 4.0
KT21512S	Yellow	5	6.3	4.0 - 6.0



**KT WATERPROOF SOLDER JOINERS**

Waterproof solder joiners combine the advantages of heat shrink and low-melt solder creating a reliable, waterproof and fully insulated connection without the use of a soldering iron, crimping tool or solder. The KT micro butane gas torch (Model No. KTTORCH/TIP) is ideal for use with waterproof solder joiners.

PRODUCT CODE	COLOUR	PACK QTY	SUITS WIRE SIZE (MM <sup>2</sup> )
KT21500S	White	5	0.5 - 1.6
KT21501S	Red	5	1.6 - 2.7
KT21502S	Blue	5	2.7 - 4.4
KT21503S	Yellow	5	4.4 - 6.9





**KT  
125A, 100V  
IN-LINE POWER METER**

Designed, design registered and developed by KT, the innovative In-line Power Meter is a simple way to monitor the Volts, Amps, Watts and battery percentage of your devices by a simple touch of the LCD screen. This unit is suitable for use with 12V, 24V & 48V applications and used to monitor the output of your solar panels in camping & marine environments.

The 'input' (also known as source) can be a battery, solar panel, generator or any other device that you would like to draw power from. The 'output' refers to the device that is drawing power from the source (also known as load). This can also be a battery.

- FEATURES**
- 12V / 24V / 48V
  - View Volts, Amps, Watts and Battery Percentage
  - Suitable for use with 12V / 24V / 48V devices
  - LCD touch display
  - Display turns off automatically after 30 seconds
  - Mounts easily to surfaces with 2 screws
  - Unique input and output designed to suit 50 Amp connectors
  - One piece, tidy molded housing
  - No messy cables
  - Back-lit display provides clear, visible readings day & night
  - Housing made of durable polycarbonate
  - 'In-line' reading from input to output only

**AN ORIGINAL KT INNOVATION**



**Battery to Device Readings ( 12V / 24V / 48V )**

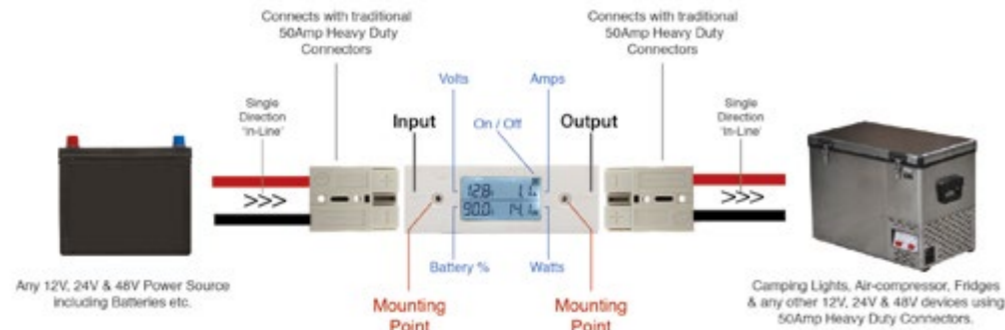

One of the many possible configurations of the KT 125A, 100V In-line Power Meter and your devices.

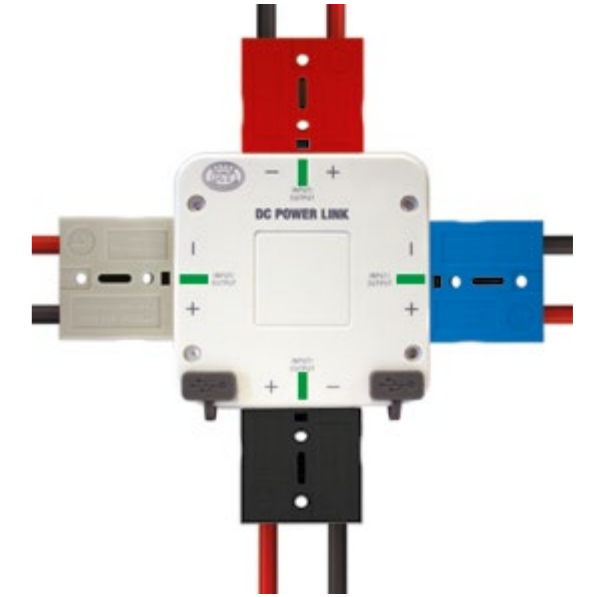

**KT  
4 WAY DC POWER LINK  
50A, 12V - 24V**

The innovative KT 50A, 12-24V, DC Power Link is a sophisticated controller with omnidirectional capabilities. The device acts as a 'power board' for your 12-24V Devices. The KT DC Power Link is essentially configured in parallel.

The unit has 4 input/output options and can support up to 3 individual inputs from a battery source/12V solar. There are many possible configurations which can be utilised for optimal use.

This unit is suitable for use with any 12V-24V DC applications and ideal for use with 12V solar, deep cycle batteries, lighting, camping fridges, air compressors, and a variety of other camping, marine, 4WD & caravanning applications.

- FEATURES**
- Suitable for 12-24V DC operations
  - LED indicator to show live circuit
  - 4 mounting points allowing easy and secure install of unit (stainless steel hardware included)
  - IP67 rated - dust proof & splash proof
  - Housing material durable UV stabilised polycarbonate
  - Connects with 50A heavy duty connectors (grey, black, red, blue)
  - Single input rated to 50A draw
  - Each output rated to 25A (50A total) at any one time
  - 2.1A and 1A USB Outputs (3.1A total)
  - Not suitable for mounting in vehicle engine bays

**AN ORIGINAL KT INNOVATION**

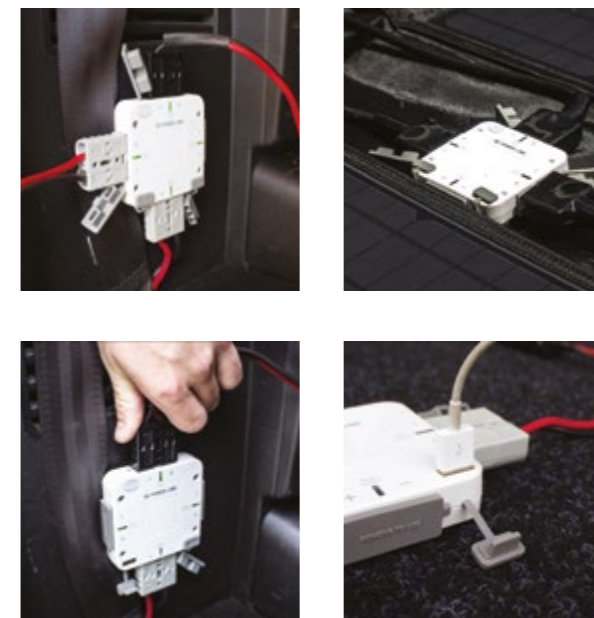

**NOTE**  
If using this product to connect multiple solar panels, a solar controller must be placed between the DC power link and the battery. (Only a single Solar controller should be used, even when connecting multiple solar panels to the DC Power Link).

ELECTRICAL 274

ELECTRICAL 275



**KT**  
**4 WAY LED DC POWER LINK**  
**50A, 12V - 24V**

The DC Power Link is a purpose-built device that can connect power from one 12/24V power source to up to 3 individual devices. View Volts, Amps, Watts, battery percentage & Amp hours of connected devices via the integrated smart-touch LCD.

View statistics at both an individual circuit level or as a complete overview of the total load on the power source. Devices and power source are connected via 50A heavy duty connectors. The device also features USB ports for charging devices including phones or tablets.

**NOTE**  
 Not suitable for mounting in vehicle engine bays.

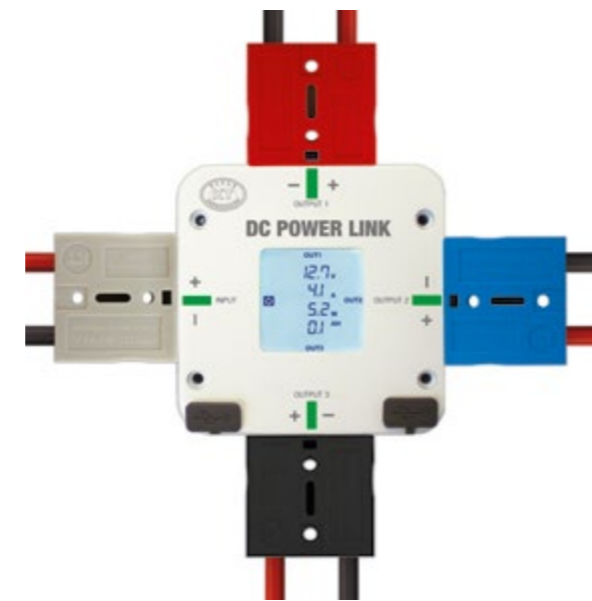

- FEATURES**
- 12V/24V
  - View Volts, Amps, Watts, battery percentage and Amp hours in 'real time'
  - LCD back-lit touch display
  - Cycles through each live circuit and displays accurate readings in 10 second intervals
  - LED indicator flashes to indicate which circuit details are currently being displayed on the LCD
  - The LCD turns off automatically after 30 seconds
  - Easy to identify 'input' and 'output' (also commonly referred to as 'load')
  - Dust proof & splash proof
  - DC Power Link connects with 50A heavy duty connectors (grey, red, black or blue)
  - Single inputs are rated to 50Amps
  - The 3 outputs are each rated to 25Amps (50Amps unit total)
  - 2.1A & 1A USB Outputs (3.1A max)

**AN ORIGINAL KT INNOVATION**

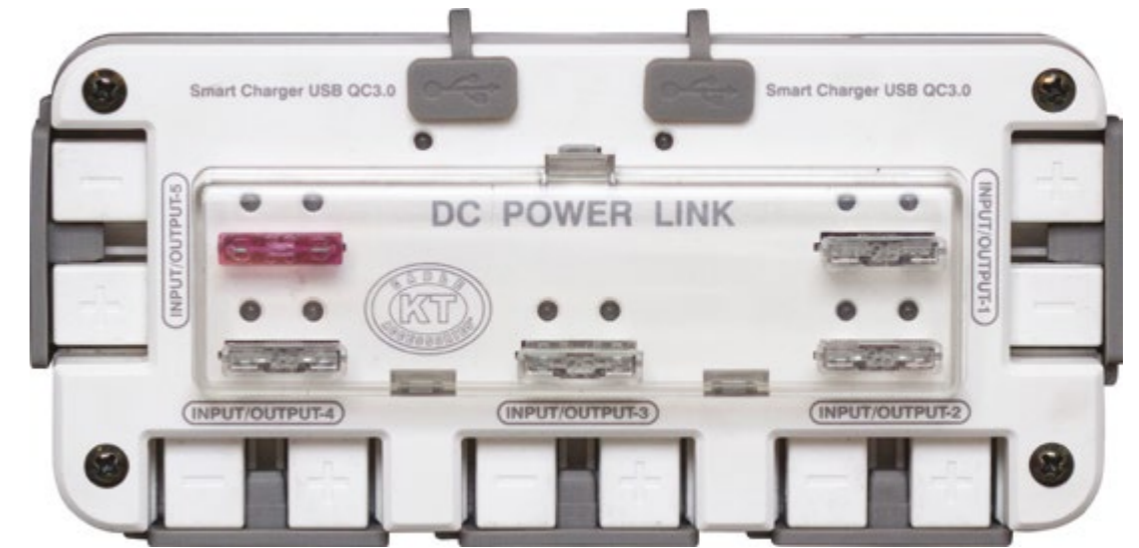

**KT**  
**5 WAY DC POWER LINK**  
**50A, 12V - 24V**

Designed to simplify 12V/24V connections. The module has 50A input/output options and can utilise power from 12V/24V batteries or direct input from solar panels. It features dual 5V USB outputs to power devices while the 50A outputs are ideal for use with solar, fridges, air compressors, and a variety of other camping, marine, 4WD, and caravanning applications.

**NOTE**  
 If using this product to connect multiple solar panels, a solar controller must be placed between the DC power link and the battery. (Only a single solar controller should be used, even when connecting multiple solar panels to the DC Power Link).

- FEATURES**
- Power up to 6 devices at once
  - Suitable for use with 12V/24V devices
  - Dual QC3.0 USB smart charge outlets (5V each) for efficient charging & powering USB devices
  - LED indicators denote live circuits, active circuits and blown fuses
  - All 50A connections are fuse protected
  - Dust proof and splash proof
  - Designed to connect with standard 50A connectors
  - Features 4 point secure mounting and easy clip on/off clear polycarbonate cover

**AN ORIGINAL KT INNOVATION**



**SPECIFICATIONS**

<b>RATED VOLTAGE</b>	12/24V
<b>POWER INPUT</b>	50A
<b>DEVICE INPUTS</b>	15A each (50A total at any one time)
<b>DIMENSIONS (MM)</b>	143 (L) x 77.2 (H) x 32 (D)



**KT  
STANDARD HEAVY DUTY  
CONNECTORS - 50A**

Available individually and in retail hang-sell blister packs. A rubber cover is included with product code KT70040S only.

- Housing is manufactured from impact-resistant polycarbonate
- Terminals included with each heavy duty connector
- Suited to 8B&S

PRODUCT CODE  
**KTHDC502S** 4 TERMINALS, 2PK  
**KT70040S** 2 TERMINALS, 1PK



**KT  
50A, 12/36V CONNECTOR  
TO 8MM RING TERMINALS**

Ideal for automotive, marine, solar & outdoor applications.

- Suitable for direct connection to a battery
- Connector Rating: 50A, 12/36V
- Connector housing: polycarbonate
- Ring terminals: 8mm
- Cable length: 300mm
- Cable type: 8mm<sup>2</sup>

PRODUCT CODE  
**KT70553**



**KT  
50A VOLTMETER  
CONNECTOR ACCESSORY**

50A, 12/36V connector with in-built voltmeter to 8mm ring terminals.

- Ideal for automotive, marine, solar & outdoor applications
- Suitable for direct connection to a battery
- Voltmeter provides live voltage reading via smart-touch LCD
- Waterproof LCD
- Voltmeter connector rating: 50A, 12/36V
- Voltmeter connector housing: polycarbonate
- Ring terminals: 8mm
- Cable length: 300mm
- Cable type: 8mm<sup>2</sup> battery cable

PRODUCT CODE  
**KT70554**



**KT  
50A, 12/36V CONNECTOR  
TO 15A ACCESSORY SOCKET**

Ideal for automotive, marine, solar & outdoor applications.

- 15A accessory socket
- Connector rating: 50A, 12/36V
- Connector housing: polycarbonate
- Cable length: 300mm
- Cable type: 4mm<sup>2</sup>

PRODUCT CODE  
**KT70555**



**KT  
50A, 12/36V CONNECTOR  
TO 15A ACCESSORY PLUG**

Ideal for automotive, marine, solar & outdoor applications

- 15A accessory plug
- Connector rating: 50A, 12/36V
- Connector housing: polycarbonate
- Cable length: 300mm
- Cable type: 4mm<sup>2</sup>

PRODUCT CODE  
**KT70558**



**KT  
50A, 12/36V CONNECTOR  
TO 200A INSULATED  
BATTERY CLAMPS**

Ideal for automotive, marine, solar & outdoor applications

- Insulated battery clamps
- Designed for connection of solar panels, portable fridges, compressors or inverters to a battery
- Connector rating: 50A, 12/36V
- Connector housing: polycarbonate
- Cable length: 300mm
- Cable type: 8mm<sup>2</sup>

PRODUCT CODE  
**KT70561**



**KT  
5M EXTENSION LEAD 50A,  
12-48V CONNECTOR TO  
50A, 12/48V CONNECTOR**

Ideal for automotive, caravan, 4wd or industrial connections requiring a 50A, 12V power supply

- Connector rating: 50A, 12V/48V
- Connector housing: polycarbonate
- Cable length (m): 5
- Cable type: 8mm<sup>2</sup> twin sheath cable
- Weight (Kg): 1.5

PRODUCT CODE  
**KT70551**



**KT  
50A HEAVY DUTY  
CONNECTOR LEAD  
SINGLE TO TWIN**

50A Heavy duty Connector terminated to twin 50A heavy duty connectors.

- Allows users to create two power connections from one
- Heavy duty connector rated to 50A at 12V/48V
- Robust polycarbonate connector housings
- 600mm lead length, 6mm<sup>2</sup> Cable
- Flame retardant corrugated loom
- Ideal for automotive, marine, solar & outdoor applications

PRODUCT CODE  
**KT70565**

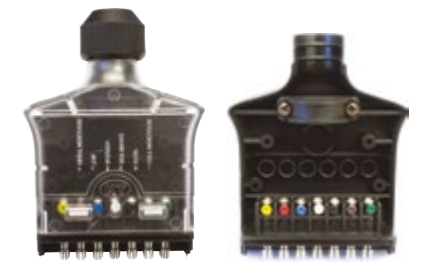

**KT**  
**1M EXTENSION LEAD, 50A, 12V-48V CONNECTOR**

**TO 50A, 12V/48V CONNECTOR**

Ideal for automotive, marine, solar & outdoor applications

- Connector Rating: 50A, 12V/48V
- Connector Housing: Polycarbonate
- Cable Protection: UV treated, flame-retardant corrugated loom with heavy duty nylon gland end pieces
- Cable length (m): 1
- Cable type: 8mm<sup>2</sup>

PRODUCT CODE  
**KT70571**

**KT**  
**3M EXTENSION LEAD, 50A, 12V-48V CONNECTOR**

**TO 50A, 12V/48V CONNECTOR**

Ideal for automotive, marine, solar & outdoor applications

- Connector Rating: 50A, 12V/48V
- Connector Housing: Polycarbonate
- Cable Protection: UV treated, flame-retardant corrugated loom with heavy duty nylon gland end pieces
- Cable Length (m): 3
- Cable Type: 8mm<sup>2</sup>

PRODUCT CODE  
**KT70572**

**KT**  
**FLAT TRAILER PLUG**

Pairs with 7 pin flat trailer sockets.

- 7 Pins rated to 15A at 12V
- Threaded screw cap
- Circuits moulded into housing
- Packaging: full colour blister

PRODUCT CODE  
**KT744**

**KT**  
**FLAT LED TRAILER SOCKET**

Features an in-built circuit tester, delivering a simple way to help diagnose any wiring faults at either the vehicle, or trailer end. Simply press the switch on the housing of the plug or socket while connected to the vehicle and apply park, brake and indicators. Each LED should illuminate to indicate a successful power connection.

- Pairs with 7 pin flat trailer plugs.
- Rated to 15A at 12V
- Built in LED circuit tester
- Threaded screw cap
- Circuits moulded into housing
- Spring-loaded dustproof cover
- Packaging: full colour blister

PRODUCT CODE  
**KT703**

**KT**  
**FLAT LED TRAILER PLUG**

Features an in-built circuit tester, delivering a simple way to help diagnose any wiring faults at either the vehicle, or trailer end. Simply press the switch on the housing of the plug or socket while connected to the vehicle and apply park, brake and indicators. Each LED should illuminate to indicate a successful power connection.

- Pairs with 7 pin flat trailer sockets.
- Rated to 15A at 12V
- Built in LED circuit tester
- Threaded screw cap
- Circuits moulded into housing
- Packaging: full colour blister
- Also available as bulk (QTY 20).

PRODUCT CODE  
**KT704**

**KT**  
**FLAT CLEAR TRAILER PLUG**

Clear trailer plug has been cleverly engineered, featuring a transparent polycarbonate casing for quick inspection of internal wiring and colour coded screws for easy cable wiring and identification. A cable gland seals the cable entry to prevent moisture and dust ingress. An internal saddle device provides strain relief and keeps wiring secure.

- 7 Pins rated to 15A at 12V.
- Clear polycarbonate housing
- Colour coded screws
- 3 step wiring body
- Circuits moulded into housing
- Packaging: full colour blister

PRODUCT CODE  
**KT744C**



**KT**  
**PORTABLE BATTERY BOX**  
**WITH VOLTMETER**

Suits battery sizes: 324(W) x 200 (H) 185mm (D).

- External dimensions: 420 (W) x 230 (H) x 290mm (D)
- Internal dimensions: 355 (W) x 205 (H) x 220mm (D)
- 1 x inbuilt battery LED voltmeter
- 2 x 12V marine grade cigarette accessory sockets
- 2 x USB inputs ( 1 x 1 & 1 x 2.1A) 3.1A total
- 1 x 16A circuit breaker for socket protection
- Illuminating Reset/off switch for 16A circuit breaker
- Heavy duty carry handle for easy transportation (not to be carried by handle with battery installed)
- High current positive/negative terminals
- Securing strap with clip
- Black screws & fittings included
- Manufactured from robust ABS plastic
- Weight: 1kg

PRODUCT CODE  
**KT71203**

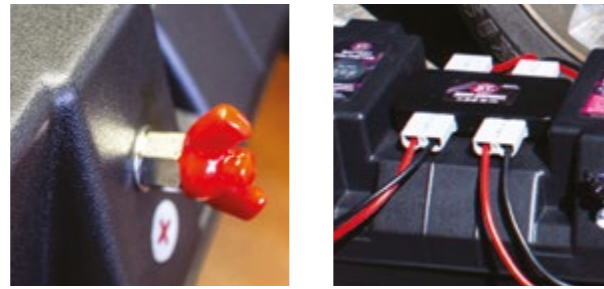

**KT**  
**PORTABLE BATTERY BOX**  
**WITH 50A 4 WAY QUAD CONNECT & VOLTMETER**

Suits battery sizes: 324 (W) x 200 (H) 185mm (D).

- External dimensions: 420 (W) x 230 (H) x 290mm (D)
- Internal dimensions: 355 (W) x 205 (H) x 220mm (D)
- Fitted with Quad-Connect to battery box lid allowing easy power access for 4 x 50A 12V devices
- Inbuilt battery LED voltmeter
- Quad-Connect suits 50A grey, blue, red & black heavy duty connectors
- 2 x 12V marine grade cigarette accessory sockets
- 2 x USB inputs ( 1 x 1A & 1 x 2.1A) 3.1A total
- 1 x 16A circuit breaker for socket protection
- Illuminating Reset/off switch for 16A circuit breaker
- High current positive/negative terminals
- Securing strap with clip
- Black screws & fittings included
- Manufactured from robust ABS plastic
- Weight: 1kg

PRODUCT CODE  
**KT71204**



**KT**  
**INTELLIGENT SURGE PROTECTED**  
**JUMPER LEADS (12/24V) - 3M**

Intelligent Jumper Leads designed to give an indication of battery health and provide an additional layer of safety to the user.

- 8000V surge protection
- 12V & 24V voltage display - voltage display will provide a voltage reading when connected to 1 battery. Voltage will be averaged when connected to 2 batteries.
- Fully insulated 50mm<sup>2</sup> battery cable
- Reverse polarity protected
- Alerts users to a flat or overcharged battery.
- LED warning indicators
  - Amber LED - temperature sensor (80°C)
  - Green LED - correct connection
  - Red LED - incorrect connection
- Packaged in a durable plastic carry case
- 100% pure copper cable
- 12 month warranty on manufacture & build

PRODUCT CODE  
**KT72301** 450A  
**KT72304** 750A





**KT  
BOOTLACE  
FERRULE CRIMPER**

- 20 - 10AWG (0.5 - 6mm<sup>2</sup>)
- Length: 230mm
- Weight: 0.6kg

PRODUCT CODE  
**KT32053**



**KT  
COAXIAL  
CABLE CRIMPER**

- 8 - 3AWG (10 - 25mm<sup>2</sup>)
- Length: 230mm
- Weight: 0.6kg

PRODUCT CODE  
**KT32054**



**KT  
COAXIAL CABLE CRIMPER**

- RG58, 59, 62, 8X, 140, 141, 174, 210, 223, 303, 400 (1 - 6.5mm<sup>2</sup>)
- Length: 230mm
- Weight: 0.6kg

PRODUCT CODE  
**KT32055**



**KT  
HEAVY DUTY  
NYLON CABLE TIE GUN**

For nylon cable ties.

- Plastic gun body
- Auto cutting
- 2.5 - 4.8mm tie range width
- Adjustable tension

PRODUCT CODE  
**KTHDCTG/P**



**KT  
HEAVY DUTY  
NYLON CABLE TIE GUN**

For nylon cable ties.

- Metal gun body
- Auto cutting
- 2.5 - 4.8mm tie range width
- Adjustable tension

PRODUCT CODE  
**KTHDCTG/M**



**KT  
HEAVY DUTY  
NYLON CABLE TIE GUN**

For nylon cable ties.

- Metal gun body
- Manual cutting
- 2.5 - 9mm tie range width
- Adjustable tension

PRODUCT CODE  
**KTHDCTG/9**



**KT  
DISTILLED WATER, 1.5L**

Using tap water to top off a battery can lower performance and shorten battery life due to water impurities that upset the normal battery function. Battery manufacturers recommend distilled water for better performance and longer battery life. Distilled water has salts and minerals removed. Water from faucets, lakes and wells usually has dissolved minerals and salts. These minerals and salts affect the chemical action in the battery. The battery works harder to maintain its charge and does not operate as efficiently. When the battery works harder, its internal temperature may get hotter while the battery is working. This causes more evaporation and requires more water. Distilled water ensures the correct battery chemical properties are maintained.

- 1.5L
- De-ionised water for use in batteries
- Less than one part per million total dissolved solids

PRODUCT CODE  
**KTDW1.5**

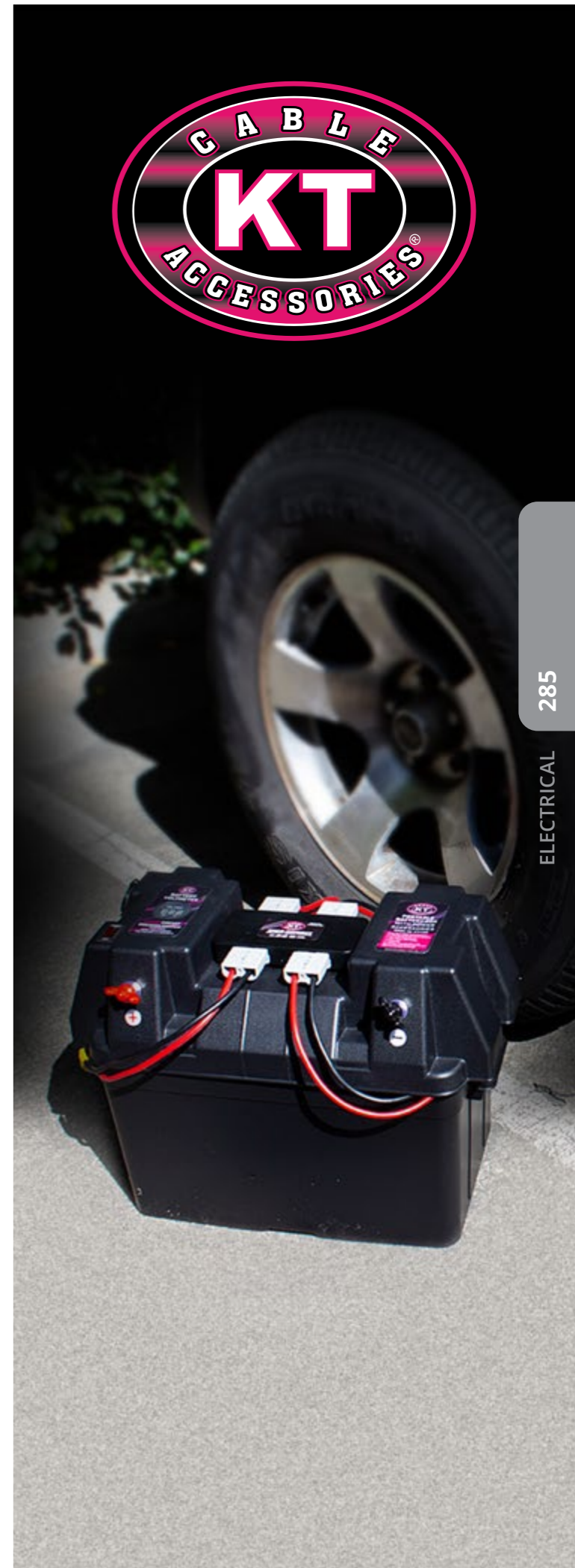

ELECTRICAL 284

ELECTRICAL 285





## EV CHARGERS & ACCESSORIES

Emergency EV Charger .....	290
Type 2 EV Charging Cables .....	291
Type 1 EV Charging Cable .....	292
Charging Adaptors .....	293
Cable End Holsters & Wall Hooks .....	294
Cable End Covers .....	294

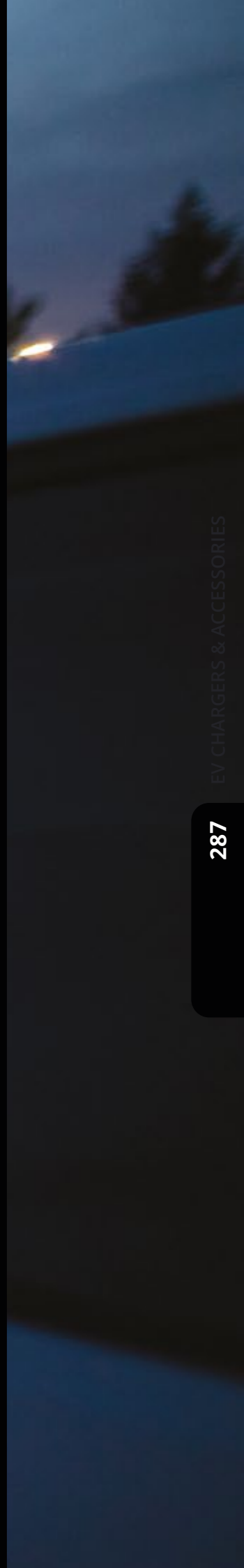

PROJECTA

# EV CHARGERS & ACCESSORIES

Projecta's EV range is the perfect compliment to any new or old EV with cables to suit both Type 1 and Type 2. It could simply be that the EV cables have been lost, or the vehicle did not come with a certain cable or required accessory. Projecta has you covered.

ALL NEW



## FEATURES & BENEFITS



WEATHER PROOF



All Projecta chargers and cables are weather proof so charging outside is not a problem.



ERGONOMIC DESIGN



Projecta's chargers have an ergonomic design for comfortable use, with the ability to endure heavy use and caps that prevent water and dirt ingress these charging cables are ready for all conditions.



HIGH QUALITY DURABLE CABLES



High quality multiple stranded EV cables allow for super flexible leads and are still able to carry large currents. 1K10 rated to withstand the toughest conditions.



EVA STORAGE CASES



Hard wearing compact heavy duty storage case to store your cables and charger safely and securely.

## ESSENTIAL ELECTRIC VEHICLE GEAR

EVERY EV OWNER MUST HAVE:

2.4KW Emergency Charger



EVC2KW

This emergency charger is ideal if you are going on holidays and require charging when you are away.

Type 1 to Type 2 Adaptor



EVAPT1T2

This adaptor is convenient for those older Type 1 public charging stations.

5 Metre Charging Cables



EVCBT2T2



EVCBT2T2-3P



EVCBT1T2

These cables allow you to charge at public sites and come in Type 1 or Type 2 configurations.

2.4 KW  
240 VOLT

NEW



**PROJECTA  
2.4KW EV EMERGENCY CHARGER**

Charging electric vehicles has never been easier while away, simply plug into a regular mains socket found in the home or garage.



**ERGONOMIC DESIGN**

For comfortable use, with the ability to endure heavy use and caps that prevent water and dirt ingress.



**LCD SCREEN**

Displays charging information so you can monitor the charge and charge status.



**EVA STORAGE CASES**

Hard wearing compact heavy duty storage case to store cables and charger safely and securely.

SPECIFICATIONS	
PART NO.	EVC2KW
PHASE	1
VOLTAGE	240V
CURRENT	10A
MAX POWER	2.4kWh
OVERALL LENGTH	5m
CABLE LENGTH	4.2m
WEIGHT	2.68kg
IP RATING	IP65
IMPACT PROTECTION	IK10
WORKING TEMPERATURE	-25~45°C
WORKING HUMIDITY	5~95%

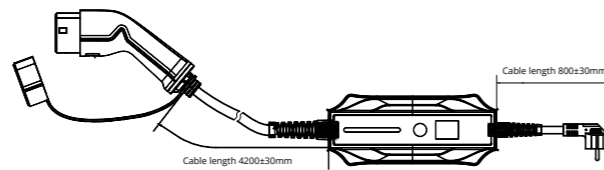

**REPLACEMENT PARTS**  
EVBS EVA CASE TO SUIT SINGLE PHASE ELECTRIC VEHICLE CHARGER

7.2 KW  
240 VOLT

NEW



EVCBT2T2 SUIT VEHICLES UP TO 7.2KW

22 KW  
400 VOLT

NEW



EVCBT2T2-3P SUIT VEHICLES UP TO 11KW / 22KW

**PROJECTA  
7.2KW & 22KW TYPE 2 EV CHARGING CABLES**

Suitable for charging Type 2 vehicles at a Type 2 charging station with single and three phase cables available.



**DURABLE DESIGN**

When connected the cable is dust proof and waterproof to IP65 rating.



**EVA STORAGE CASES**

Hard wearing compact heavy duty storage case to store cables and charger safely and securely.



**ERGONOMIC DESIGN**

Ergonomically designed grips for easy connection to vehicle and charger.



**SHOCK PROOF**

Designed to IK10 protection. This means connectors are not going to break easily.

SPECIFICATIONS		
PART NO.	EVCBT2T2	EVCBT2T2-3P
PHASE	1	3
VOLTAGE	240V	400V
CURRENT	32A	32A
MAX POWER	7.2kWh	22kWh
OVERALL LENGTH	5m	5m
CABLE LENGTH	4.6m	4.6m
WEIGHT	2.33kg	3.39kg
IP RATING	IP65	
IMPACT PROTECTION	IK10	
WORKING TEMPERATURE	-25~45°C	
WORKING HUMIDITY	5~95%	
BATTERY CHARGE TIMES		
30KWH BATTERY	4 hrs	1.5 hrs
60KWH BATTERY	8 hrs	3 hrs
90KWH BATTERY	12 hrs	4.5 hrs

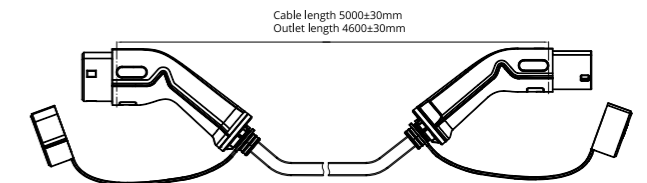

**REPLACEMENT PARTS**  
EVBR EVA CASE TO SUIT ELECTRIC VEHICLE CABLES

7.2 KW  
240 VOLT



**PROJECTA**  
**7.2KW TYPE 1 EV CHARGING CABLE**

Suitable for charging your Type 1 vehicle at a Type 2 charging station. This is a must have for those older Type 1 vehicles.



**DURABLE DESIGN**  
When connected the cable is dust proof and waterproof to IP65 rating.



**EVA STORAGE CASES**  
Hard wearing compact heavy duty storage case to store cables and charger safely and securely.



**ERGONOMIC DESIGN**  
Ergonomically designed grips for easy connection to vehicle and charger.



**SHOCK PROOF**  
Designed to 1K10 protection. This means connectors are not going to break easily.

SPECIFICATIONS	
PART NO.	EVCBT2T1
PHASE	1
VOLTAGE	240V
CURRENT	32A
MAX POWER	7.2kW
OVERALL LENGTH	5m
CABLE LENGTH	4.6m
WEIGHT	2.27kg
IP RATING	IP65
IMPACT PROTECTION	IK10
WORKING TEMPERATURE	-30~50°C
WORKING HUMIDITY	5~95%
BATTERY CHARGE TIMES	
30kWh BATTERY	4 hrs
60kWh BATTERY	8 hrs
90kWh BATTERY	12 hrs

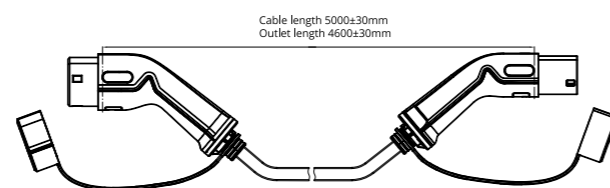

**REPLACEMENT PARTS**  
**EVBR EVA CASE TO SUIT ELECTRIC VEHICLE CABLES**



Be ready to charge at any station with Projecta's convenient adaptors.



**PROJECTA**  
**TYPE 1 TO TYPE 2 ADAPTOR**

For Charging a Type 2 vehicle at a Type 1 charging station.

SPECIFICATIONS	
PART NO.	EVAPT1T2
RATED CURRENT	32A Max
RATED VOLTAGE	250V AC
INGRESS PROTECTION	IP23
VOLTAGE WITHSTAND	2000V AC 5S
FLAME-RETARDANT	UL94V-0
WORKING TEMPERATURE	-30°C ~ +50°C

PRODUCT CODE  
**EVAPT1T2**



**PROJECTA**  
**TYPE 2 TO TYPE 1 ADAPTOR**

For charging a Type 1 vehicle at a Type 2 charging station.

SPECIFICATIONS	
PART NO.	EVAPT2T1
RATED CURRENT	32A Max
RATED VOLTAGE	250V AC
INGRESS PROTECTION	IP65
VOLTAGE WITHSTAND	2000V AC 5S
FLAME-RETARDANT	UL94V-0
CABLE LENGTH	0.3m
WORKING TEMPERATURE	-30°C ~ +50°C

PRODUCT CODE  
**EVAPT2T1**

Assorted cable end holsters and wall hooks to assist in the storage of your charging cables.



**PROJECTA  
TYPE 1 EV  
CABLE END HOLSTER**

This durable Type 1 holster is moulded to suit a Type 1 outlet connector, made from engineered plastic with high UV resistance to avoid sun damage. Includes mounting hardware for easy installation.

PRODUCT CODE  
**EVEHT1**



**PROJECTA  
TYPE 2 EV  
CABLE END HOLSTER**

This durable Type 2 holster is moulded to suit a Type 2 outlet connector, made from engineered plastic with high UV resistance to avoid sun damage. Includes mounting hardware for easy installation.

PRODUCT CODE  
**EVEHT2**



**PROJECTA  
TYPE 1 EV  
CABLE END HOLSTER**

The Type 1 holster and cable hook is made to suit Type 1 outlet and can be mounted next to a charger. It is made from durable ABS, PC plastics. Includes mounting hardware for easy installation.

PRODUCT CODE  
**EVWHT1**



**PROJECTA  
TYPE 2 EV  
CABLE END HOLSTER**

The Type 2 holster and cable hook is made to suit Type 2 outlet and can be mounted next to a charger. It is made from durable ABS, PC plastics. Includes mounting hardware for easy installation.

PRODUCT CODE  
**EVWHT2**

Assorted replacement covers for Type 1 and Type 2 connectors. Made from a pliable and strong silicone rubber.



**PROJECTA  
TYPE 1 OUTLET COVER**

Moulded to suit Type 1 connectors. Creating the perfect seal with the connector to keep dust and water out.

PRODUCT CODE  
**EVOCT1**



**PROJECTA  
TYPE 2 INLET COVER**

Moulded to suit Type 2 inlet connectors. Creating the perfect seal with the connector to keep dust and water out.

PRODUCT CODE  
**EVICT2**



**PROJECTA  
TYPE 2 OUTLET COVER**

Moulded to suit Type 2 outlet connectors. Creating the perfect seal with the connector to keep dust and water out.

PRODUCT CODE  
**EVOCT2**



**ASK US FOR  
A PROJECTA  
PRODUCT  
CATALOGUE**

- BATTERY CHARGERS
- SOLAR PANELS & CONTROLLERS
- INVERTERS
- POWER MANAGEMENT
- JUMP STARTERS
- BOOSTER CABLES
- DUAL BATTERY SYSTEMS
- BATTERY TERMINALS
- BATTERY MAINTENANCE
- PERSONAL POWER
- SWITCHES & POWER POINTS
- LITHIUM BATTERIES
- TOWING & SAFETY

We stock the full and comprehensive range of Projecta products.



## SOLAR PANELS & CONTROLLERS

Projecta Solar Range .....	298
Projecta 12V Maintenance Solar Panels.....	300
Projecta 12V Soft Folding Solar Panel Kits .....	302
Projecta 12V Fixed Solar Panels .....	304
Projecta 12V Fixed Panels & MC4 Connectors .....	306
Projecta 12V Semi Flexible Solar Panel .....	308
Projecta Solar Controllers .....	312
Projecta Solar Accessories .....	326
KT Solar Solutions .....	328
KT Solar Panels.....	329
KT Solar Charging Systems .....	332
KT Portable, Folding Solar Solutions.....	334
KT Solar Panel Mounts .....	341
KT Solar Charge Controllers .....	342
KT Solar Leads & Connectors .....	347

PROJECTA

# SOLAR RANGE

**NO FUEL. NO NOISE. NO NEED TO GO HOME.**

Projecta's extensive range of solar panels include two types of technologies, each serving a different purpose and budget. These include the amorphous panels which are more suited to maintenance style requirements, and monocrystalline panels which generate greater power more efficiently and are ideal for charging larger batteries.

SOLAR PANELS & CONTROLLERS



**PROJECTA**

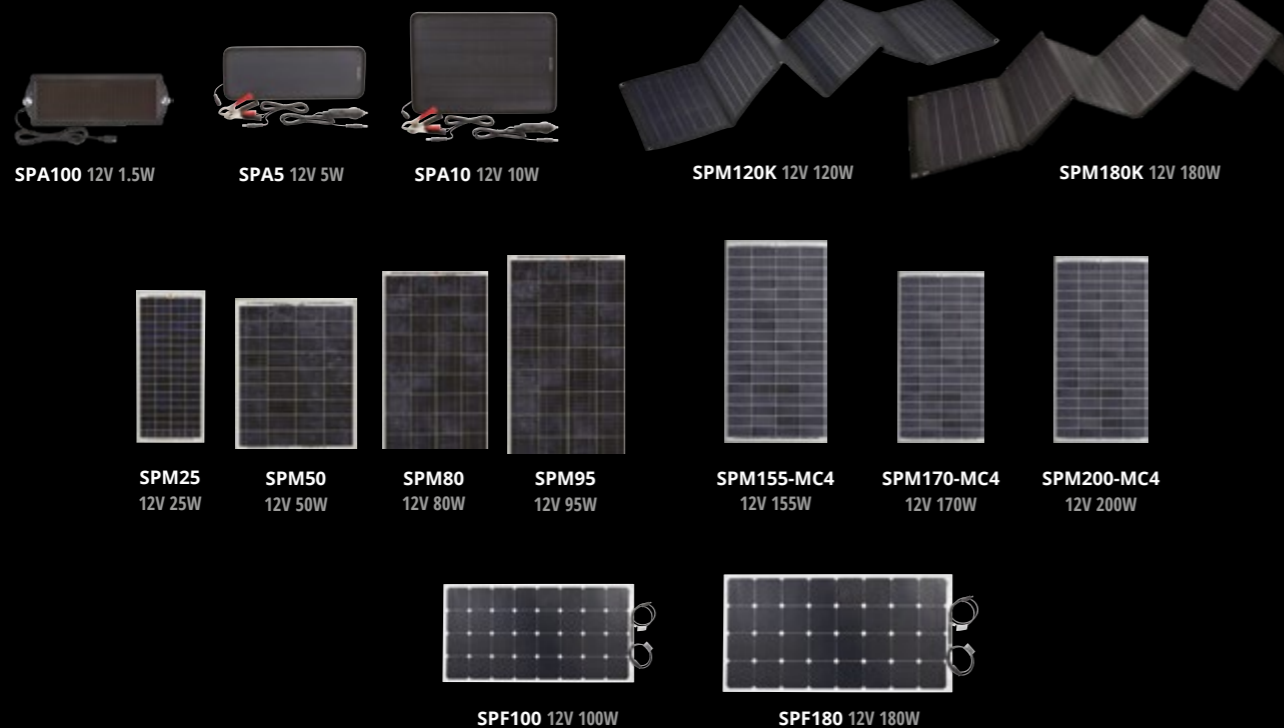

SPA100 12V 1.5W   SPA5 12V 5W   SPA10 12V 10W   SPM120K 12V 120W   SPM180K 12V 180W

SPM25 12V 25W   SPM50 12V 50W   SPM80 12V 80W   SPM95 12V 95W   SPM155-MC4 12V 155W   SPM170-MC4 12V 170W   SPM200-MC4 12V 200W

SPF100 12V 100W   SPF180 12V 180W

## FEATURES & BENEFITS

### MAINTENANCE PANELS

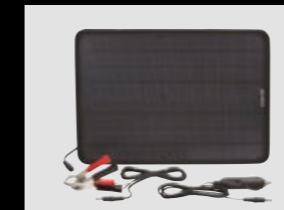

The SPA100, SPA5 & SPA10 solar panels are compact and easy to place in a vehicle to ensure the starter battery is always topped up.

### SOFT FOLDING KITS



Tough portable solar panel kits featuring a frameless design that folds up into a convenient compact bag. Includes support legs, built-in solar controller and 5m lead with battery clips.

### FIXED PANELS

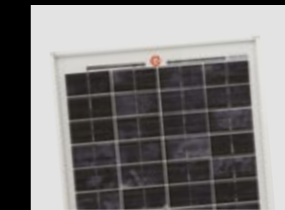

Wide range of fixed panels offer power for small or large energy consuming setups.

### SEMI FLEXIBLE PANELS



Utilising super efficient monocrystalline technology, these semi flexible panels are ideal for slightly curved surfaces and come with pre-applied adhesive.

## DIY SOLAR ACCESSORIES

Projecta offers a comprehensive range of solar accessories including pre-made leads, MC4 Type connectors and durable aluminium mounting rails to allow a professional and easy installation for the DIYer.

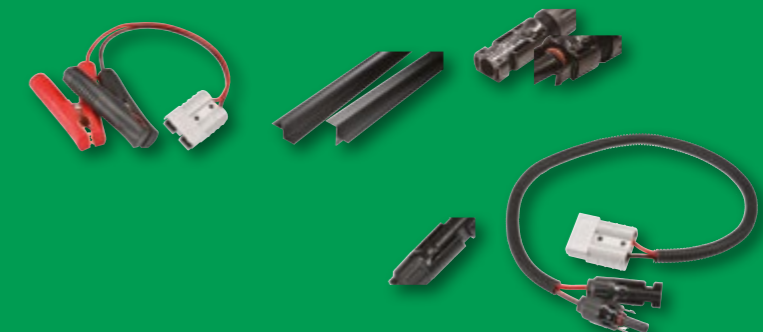

TURN TO PAGE 326 FOR THE COMPLETE RANGE.

## SELECTING THE CORRECT SIZE SOLAR PANELS

Solar panels can be utilised to extend battery run time when powering multiple accessories. A number of factors that can influence this include: the time of year, weather conditions, battery capacity and how long appliances are run. Below is a guide to help select the correct size panel.

### AVERAGE SUN HOURS

SUMMER	WINTER	ANNUAL
6.6	2.8	4.7

### TYPICAL CONSUMPTION LOAD

APPLIANCE	AMP DRAW	HOURS RUN	DAILY CONSUMPTION
1x Fluoro Light	1	5	5
L.E.D Lighting	0.2	5	1
Fridge	1	24	24
TOTAL			30

### SOLAR PANEL OUTPUT

WATTS	AMPS
20	1.25
40	2.5
60	3.8
80	5.0
120	7.5
135	8.5
160	10
180	11

## TYPICAL EXAMPLE

Below are simple workings to assist with calculating requirements. Refer to the above tables for values:

$$\text{SOLAR PANEL SIZE} = \frac{\text{CONSUMPTION} - (\text{BATTERY CAPACITY} / \text{DAYS AWAY})}{\text{SUNLIGHT HOURS}}$$

Calculated example as follows: 4.3 Amps\* =  $\frac{30A/H - (100 A/H / 10 \text{ days})}{4.7 \text{ hours}}$

\*Refer Solar Panel Output Chart above for suitable panel size.

SOLAR PANELS & CONTROLLERS

299

1.5 WATT



**PROJECTA AMORPHOUS 1.5W 12V MAINTENANCE SOLAR PANEL**

Longer battery life for infrequently used vehicles. Ensures your vehicle starts even after extended periods without use.



**CONNECTION OPTIONS**  
2.7m of cable and simple connection via 12V cigarette plug or battery clips.



**L.E.D INDICATOR**  
Flashing blue L.E.D denotes charging while in-built blocking diode protects against reverse discharge.



**EFFICIENT PERFORMANCE**  
Amorphous solar cells use the sun's power to maintain the battery in peak condition, even in low light (cloudy) conditions.

SPECIFICATIONS	
PART NO.	SPA100
TYPE	Amorphous
RATED POWER	1.5W (12V)
SHORT CIRCUIT CURRENT	0.115A
PEAK POWER VOLTAGE	13-15V
PEAK POWER CURRENT	90-100mAh (max)
TEST CONDITIONS	1000W/m <sup>2</sup> , 25°C
BATTERY CHARGE TIMES	
AUTOMOTIVE	100-550CCA
MARINE	150-600MCA
DEEP CYCLE	7-40Ah
CHARGING TIME	Maintenance

**2 YEAR WARRANTY\***

\* 1 year warranty for materials and workmanship and a 2 year warranty for at least 80% output.

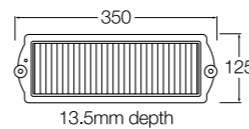

5 WATT  
10 WATT

ALL NEW



SPA5



SPA10

**PROJECTA MONOCRYSTALLINE 5W & 10W 12V MAINTENANCE SOLAR PANEL**

Monocrystalline panels provide versatile mounting options and are able to maintain primary or secondary batteries, ensuring a vehicle's batteries are maintained over extended periods without use.



**SLIM & COMPACT**  
Slim, flexible and compact panels provide versatile mounting options such as sun visors.



**HIGH PERFORMANCE**  
Super efficient monocrystalline technology produces more power via a smaller sized panel to effectively maintain a vehicle battery.



**PLUG & PLAY**  
Panels are equipped with suction caps, 12V plug and battery clamp adaptor.

SPECIFICATIONS		
PART NO.	SPA5	SPA10
TYPE	Monocrystalline	Monocrystalline
RATED POWER	5W (12V)	10W (12V)
SHORT CIRCUIT CURRENT	0.28A	0.60A
PEAK POWER VOLTAGE	18-23V	18-23V
PEAK POWER CURRENT	250-280mAh (max)	400-600mAh (max)
TEST CONDITIONS	1000W/m <sup>2</sup> , 25°C	1000W/m <sup>2</sup> , 25°C
BATTERY CHARGE TIMES		
AUTOMOTIVE	100-550CCA	100-550CCA
MARINE	150-600MCA	150-600MCA
DEEP CYCLE	7-40Ah	7-40Ah
CHARGING TIME	Maintenance	Maintenance

**2 YEAR WARRANTY\***

\* 1 year warranty for materials and workmanship and a 2 year warranty for at least 80% output.

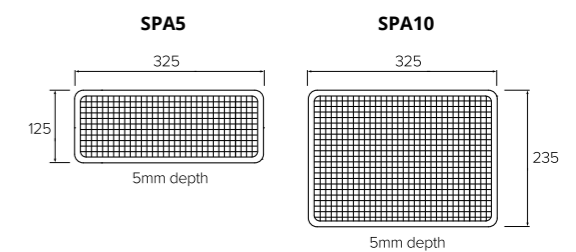



120 WATT

NEW & IMPROVED  
MORE COMPACT  
SAME GREAT POWER!



Includes solar controller

**PROJECTA  
MONOCRYSTALLINE 120W  
12V SOFT FOLDING SOLAR PANEL KIT**

Utilising super efficient monocrystalline technology, these compact, lightweight and powerful kits are ideal for the traveller looking to explore remote locations and extend their stay off the grid. Complete and ready to use, simply unfold and connect to a vehicle battery.



**FRAMELESS FOLDABLE DESIGN**  
Folds up into a durable self contained canvas bag for easy, safe storage.



**5 METRE CABLE**  
Fused battery lead makes for trouble free battery connection. Front pocket for easy storage.



**METAL SUPPORT LEGS**  
Legs keep the panel at the optimum angle for maximum performance.



**BUILT-IN SOLAR CONTROLLER**  
Advanced 4 stage controller maintains batteries in peak condition and protects against overcharging and solar discharge.



**SCRATCH RESISTANT**  
Panels feature a scratch resistant matt coating for enhanced durability.

SPECIFICATIONS			
PART NO.	SPM120K		
TYPE	Monocrystalline		
RATED POWER	120W (12V)		
OPEN CIRCUIT VOLTAGE	21V		
SHORT CIRCUIT CURRENT	7.52A		
PEAK POWER VOLTAGE	17.5V		
PEAK POWER CURRENT	6.86A		
TEST CONDITIONS	1000W/m <sup>2</sup> , 25°C		
SOLAR CONTROLLER RATING	10A		
BATTERY CHARGE TIMES			
AUTOMOTIVE	250-1200CCA		
MARINE	250-1500MCA		
DEEP CYCLE	40-200Ah		
CHARGING TIME	7-35 hours		
BATTERY CHARGE TIMES			
Height	Width	Depth	
FOLDED	440	370	60
UNFOLDED	440	2250	40
WEIGHT	7kg		

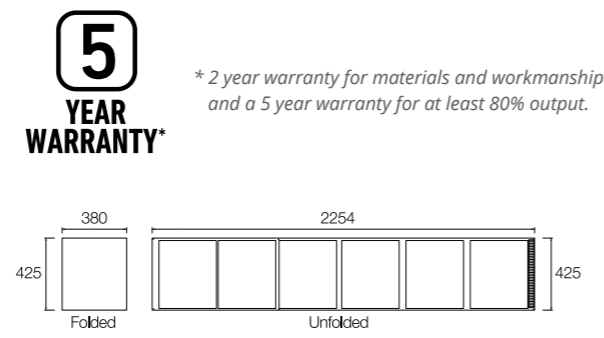

**REPLACEMENT PARTS**  
SPMLEG METAL SUPPORT LEG  
SPM120POL COLLAPSIBLE SUPPORT POLE

180 WATT

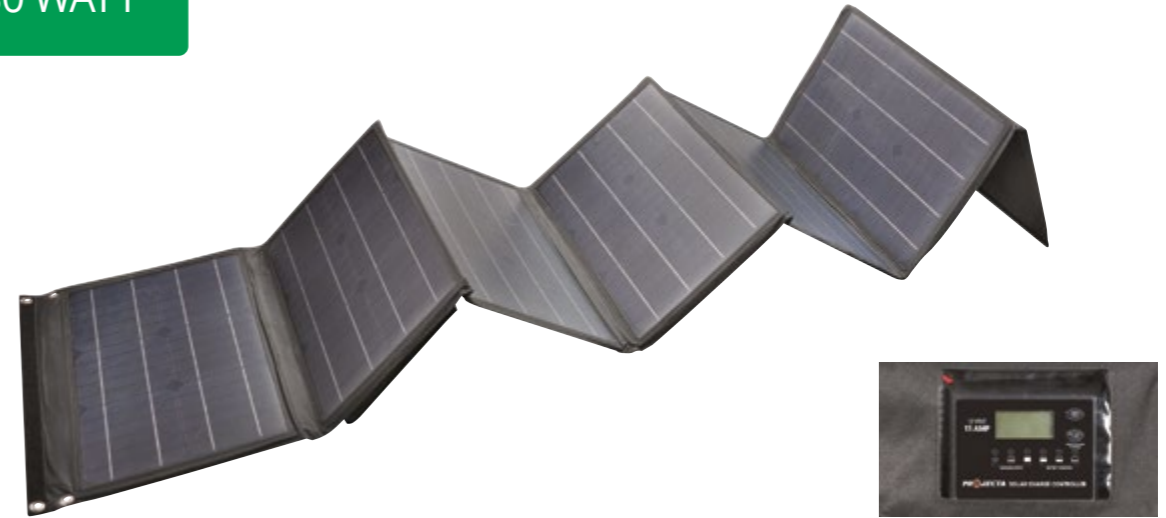

Includes solar controller

**PROJECTA  
MONOCRYSTALLINE 180W  
12V SOFT FOLDING SOLAR PANEL KIT**

The largest of the folding kits, this 180 Watt panel can produce upwards of 11 Ah in ideal conditions, producing ample power to charge a 4WD, camper trailer or caravan batteries whilst away from conventional power.



**FRAMELESS FOLDABLE DESIGN**  
Folds up into a durable self contained canvas bag for easy, safe storage.



**5 METRE CABLE**  
Fused battery lead makes for trouble free battery connection. Front pocket for easy storage.



**METAL SUPPORT LEGS**  
Legs keep the panel at the optimum angle for maximum performance.



**BUILT-IN SOLAR CONTROLLER**  
Advanced 4 stage controller maintains batteries in peak condition and protects against overcharging and solar discharge.



**SCRATCH RESISTANT**  
Panels feature a scratch resistant matt coating for enhanced durability.

SPECIFICATIONS			
PART NO.	SPM180K		
TYPE	Monocrystalline		
RATED POWER	180W (12V)		
OPEN CIRCUIT VOLTAGE	21V		
SHORT CIRCUIT CURRENT	11.0A		
PEAK POWER VOLTAGE	18V		
PEAK POWER CURRENT	10.3A		
TEST CONDITIONS	1000W/m <sup>2</sup> , 25°C		
SOLAR CONTROLLER RATING	10A		
BATTERY CHARGE TIMES			
AUTOMOTIVE	250-1800CCA		
MARINE	250-2300MCA		
DEEP CYCLE	40-300Ah		
CHARGING TIME	7-35 hours		
BATTERY CHARGE TIMES			
Height	Width	Depth	
FOLDED	560	380	90
UNFOLDED	560	2580	45
WEIGHT	8.3kg		

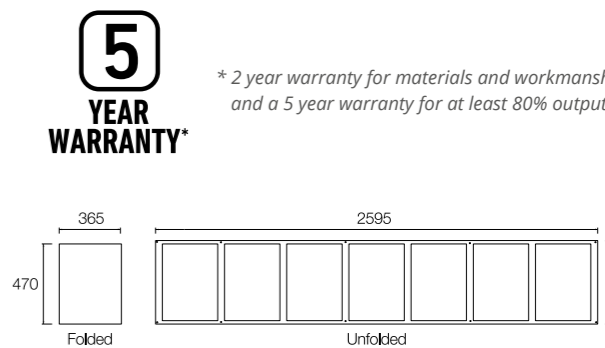

**REPLACEMENT PARTS**  
SPM180LEG METAL SUPPORT LEG  
SPM180POL COLLAPSIBLE SUPPORT POLE

SOLAR PANELS & CONTROLLERS

SOLAR PANELS & CONTROLLERS

25 WATT  
50 WATT

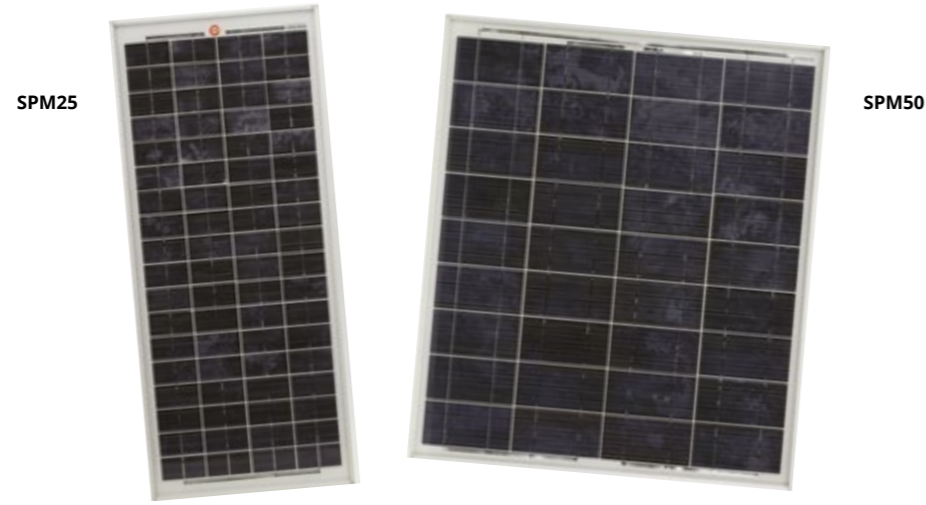

— NOW —  
MONOCRYSTALLINE

**PROJECTA  
MONOCRYSTALLINE 25W & 50W  
12V FIXED SOLAR PANELS**

The ideal panel sizes to charge and maintain infrequently used batteries where 240V power is not easily accessible.



**SEALED JUNCTION BOX**  
Protects against external elements and includes connection terminals.



**TEMPERED LOW IRON GLASS**  
Provides better impact resistance and improved light transmission.



**HEAVY DUTY FRAME**  
Superior strength and durability.



**HIGH PERFORMANCE**  
Super efficient monocrystalline technology produces more power via a smaller sized panel to effectively maintain a battery.

SPECIFICATIONS		
PART NO.	SPM25	SPM50
TYPE	Monocrystalline	Monocrystalline
RATED POWER	25W (12V)	50W (12V)
OPEN CIRCUIT VOLTAGE	21V	21V
SHORT CIRCUIT CURRENT	1.56A	3.13A
PEAK POWER VOLTAGE	17.5V	17.5V
PEAK POWER CURRENT	1.43A	2.86A
TEST CONDITIONS	1000W/m <sup>2</sup> , 25°C	1000W/m <sup>2</sup> , 25°C
BATTERY CHARGE TIMES		
AUTOMOTIVE	200-500CCA	250-750CCA
MARINE	250-550MCA	250-800MCA
DEEP CYCLE	20-50Ah	20-70Ah
CHARGING TIME	Maintenance	10-30 hours

**20  
YEAR  
WARRANTY\***

\*1 year warranty for materials and workmanship and a 20 year warranty for at least 80% output.

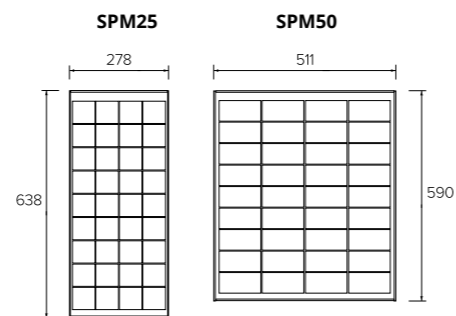

All panels: 25mm depth

PRODUCT CODE  
**SPM25** 25W  
**SPM50** 50W

80 WATT  
95 WATT



— NOW —  
MONOCRYSTALLINE

**PROJECTA  
MONOCRYSTALLINE 80W & 95W  
12V FIXED SOLAR PANELS**

Ideal for charging large batteries and extending battery run time, suiting leisure vehicles and travelling.



**SEALED JUNCTION BOX**  
Protects against external elements and includes connection terminals.



**TEMPERED LOW IRON GLASS**  
Provides better impact resistance and improved light transmission.



**HEAVY DUTY FRAME**  
Superior strength and durability.



**HIGH PERFORMANCE**  
Super efficient monocrystalline technology produces more power via a smaller sized panel to effectively maintain a battery.

SPECIFICATIONS		
PART NO.	SPM80	SPM95
TYPE	Monocrystalline	Monocrystalline
RATED POWER	80W (12V)	95W (12V)
OPEN CIRCUIT VOLTAGE	21V	21V
SHORT CIRCUIT CURRENT	1.56A	3.13A
PEAK POWER VOLTAGE	17.5V	17.5V
PEAK POWER CURRENT	4.57A	5.43A
TEST CONDITIONS	1000W/m <sup>2</sup> , 25°C	1000W/m <sup>2</sup> , 25°C
BATTERY CHARGE TIMES		
AUTOMOTIVE	200-650CCA	250-900CCA
MARINE	300-700MCA	350-1000MCA
DEEP CYCLE	20-100Ah	30-140Ah
CHARGING TIME	7-35 hours	7-35 hours

**20  
YEAR  
WARRANTY\***

\*1 year warranty for materials and workmanship and a 20 year warranty for at least 80% output.

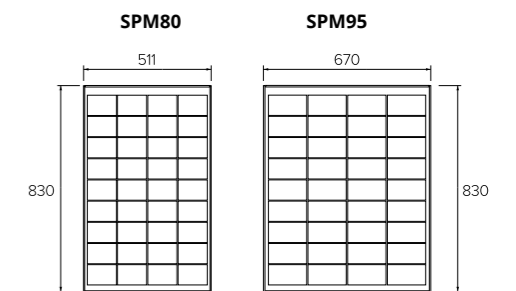

All panels: 35mm depth

PRODUCT CODE  
**SPM80** 80W  
**SPM95** 95W

155 WATT  
170 WATT



SPM155-MC4

SPM170-MC4

MC4 TYPE CONNECTOR PLUGS



MC4-2

Single pin waterproof positive and negative connectors with terminals and seals.

— NOW —  
MONOCRYSTALLINE

PROJECTA  
MONOCRYSTALLINE 155W & 170W  
12V FIXED SOLAR PANELS WITH MC4 TYPE CONNECTORS

Made for permanent mounting these panels are ideal for caravans, motor homes, house boats, remote holiday shacks and farming applications where power is required to charge battery banks servicing multiple or larger appliances.



MC4 TYPE CONNECTOR

Standardised MC4 type connector fitted for ease of installation where MC4 type connectors are used.



TEMPERED LOW IRON GLASS

Provides better impact resistance and improved light transmission.



HEAVY DUTY FRAME

Superior strength and durability.

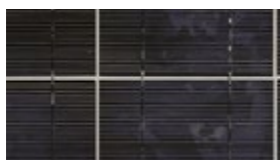

HIGH PERFORMANCE

Super efficient monocrystalline technology produces more power via a smaller sized panel to effectively maintain a battery.

SPECIFICATIONS		
PART NO.	SPM155-MC4	SPM170-MC4
TYPE	Monocrystalline	Monocrystalline
RATED POWER	155W (12V)	170W (12V)
OPEN CIRCUIT VOLTAGE	21V	21V
SHORT CIRCUIT CURRENT	9.69A	10.63A
PEAK POWER VOLTAGE	17.5V	17.5V
PEAK POWER CURRENT	8.86A	9.71A
TEST CONDITIONS	1000W/m <sup>2</sup> , 25°C	1000W/m <sup>2</sup> , 25°C
BATTERY CHARGE TIMES		
AUTOMOTIVE	250-1200CCA	300-1300CCA
MARINE	350-1500MCA	400-2000MCA
DEEP CYCLE	40-200Ah	50-240Ah
CHARGING TIME	7-35 hours	7-35 hours

**20**  
YEAR  
WARRANTY\*

\*1 year warranty for materials and workmanship and a 20 year warranty for at least 80% output.

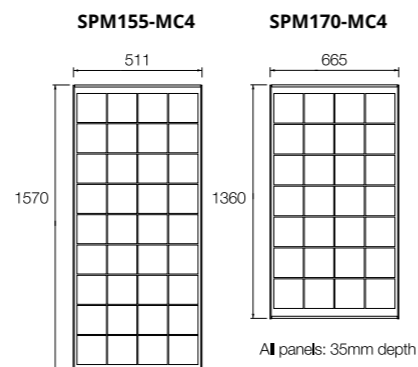

PRODUCT CODE  
SPM155-MC4 155W  
SPM170-MC4 170W

200 WATT

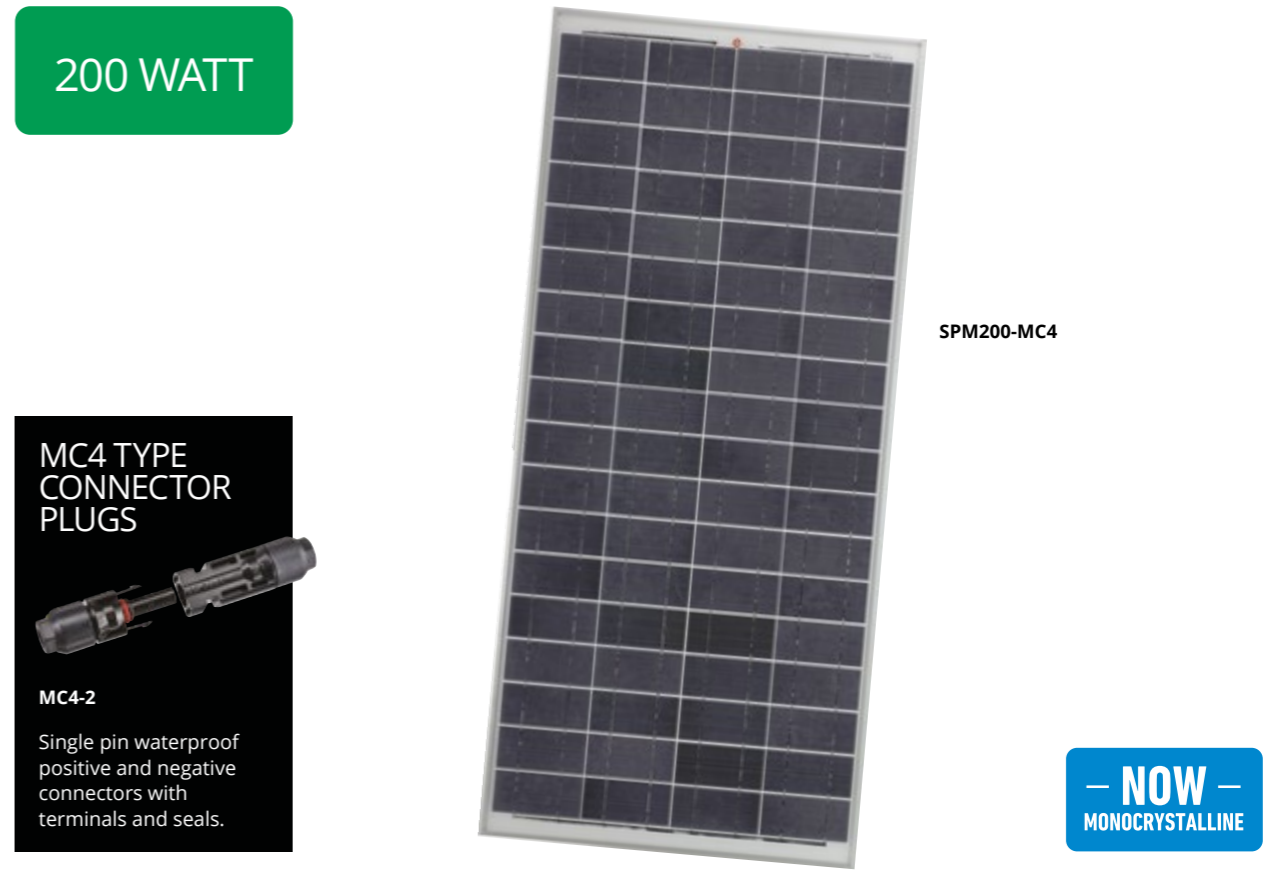

SPM200-MC4

MC4 TYPE CONNECTOR PLUGS



MC4-2

Single pin waterproof positive and negative connectors with terminals and seals.

— NOW —  
MONOCRYSTALLINE

PROJECTA  
MONOCRYSTALLINE 200W  
12V FIXED SOLAR PANELS WITH MC4 TYPE CONNECTORS

Made for permanent mounting these panels are ideal for caravans, motor homes, house boats, remote holiday shacks and farming applications where power is required to charge battery banks servicing multiple or larger appliances.



MC4 TYPE CONNECTOR

Standardised MC4 type connector fitted for ease of installation where MC4 type connectors are used.



TEMPERED LOW IRON GLASS

Provides better impact resistance and improved light transmission.



HEAVY DUTY FRAME

Superior strength and durability.

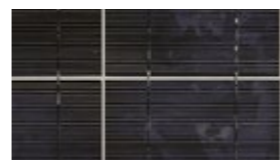

HIGH PERFORMANCE

Super efficient monocrystalline technology produces more power via a smaller sized panel to effectively maintain a battery.

SPECIFICATIONS	
PART NO.	SPM200-MC4
TYPE	Monocrystalline
RATED POWER	200W (12V)
OPEN CIRCUIT VOLTAGE	23.2V
SHORT CIRCUIT CURRENT	11.27A
PEAK POWER VOLTAGE	17.5V
PEAK POWER CURRENT	19.6V
TEST CONDITIONS	1000W/m <sup>2</sup> , 25°C
BATTERY CHARGE TIMES	
AUTOMOTIVE	600-2000CCA
MARINE	750-2500MCA
DEEP CYCLE	75-340Ah
CHARGING TIME	7-35 hours

**20**  
YEAR  
WARRANTY\*

\*1 year warranty for materials and workmanship and a 20 year warranty for at least 80% output.

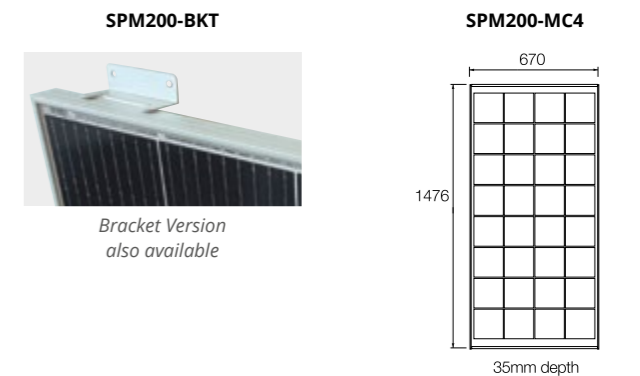

PRODUCT CODE  
SPM200-MC4 200W

100 WATT

NEW

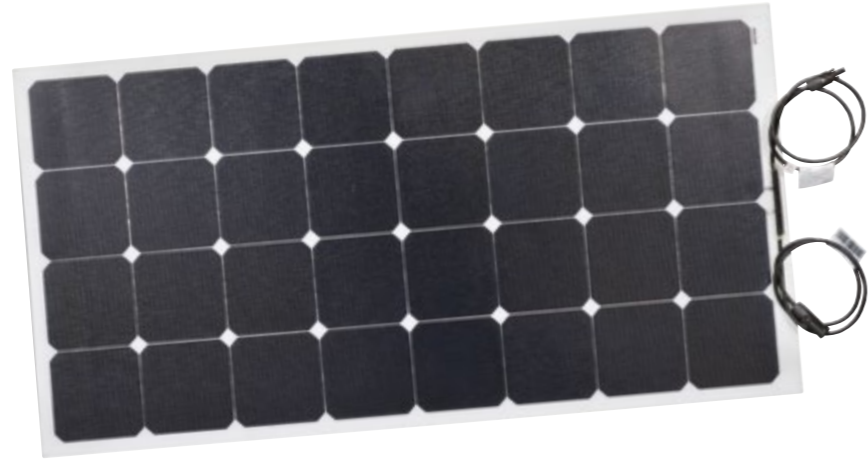

**PROJECTA MONOCRYSTALLINE 100W SEMI FLEXIBLE SOLAR PANEL**

Made for permanent mounting on surfaces that have a slight contour or curve. It will suit applications such as canopies or trailers with battery banks servicing small to medium electrical appliances.

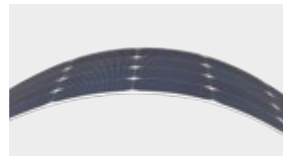

**LIGHTWEIGHT & FLEXIBLE**  
The panels weigh as little as 2kgs, being flexible also gives greater mounting options.

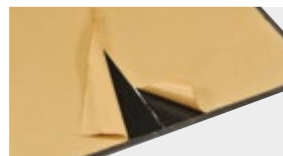

**PRE-APPLIED ADHESIVE**  
The panels come supplied with a super tough adhesive allowing users to mount them with confidence.



**MC4 TYPE CONNECTOR**  
Standardised MC4 type connector fitted for ease of installation.

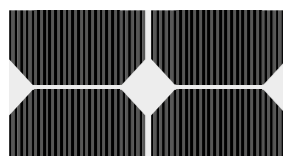

**HIGH PERFORMANCE**  
Super efficient monocrystalline technology produces more power via a smaller sized panel to effectively maintain a battery.

SPECIFICATIONS	
PART NO.	SPF100
TYPE	Monocrystalline
RATED POWER	100W (12V)
OPEN CIRCUIT VOLTAGE	24.5V
SHORT CIRCUIT CURRENT	4.9A
PEAK POWER VOLTAGE	20.9V
PEAK POWER CURRENT	4.7A
MAXIMUM BENDING RADIUS	400mm
TEST CONDITIONS	1000W/m <sup>2</sup> , 25°C
WEIGHT	2.0kg
BATTERY CHARGE TIMES	
AUTOMOTIVE	600-2000CCA
MARINE	750-2500MCA
DEEP CYCLE	75-340Ah
CHARGING TIME	7-35 hours

**2 YEAR WARRANTY**

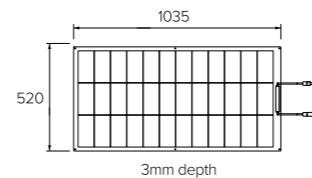

180 WATT

NEW

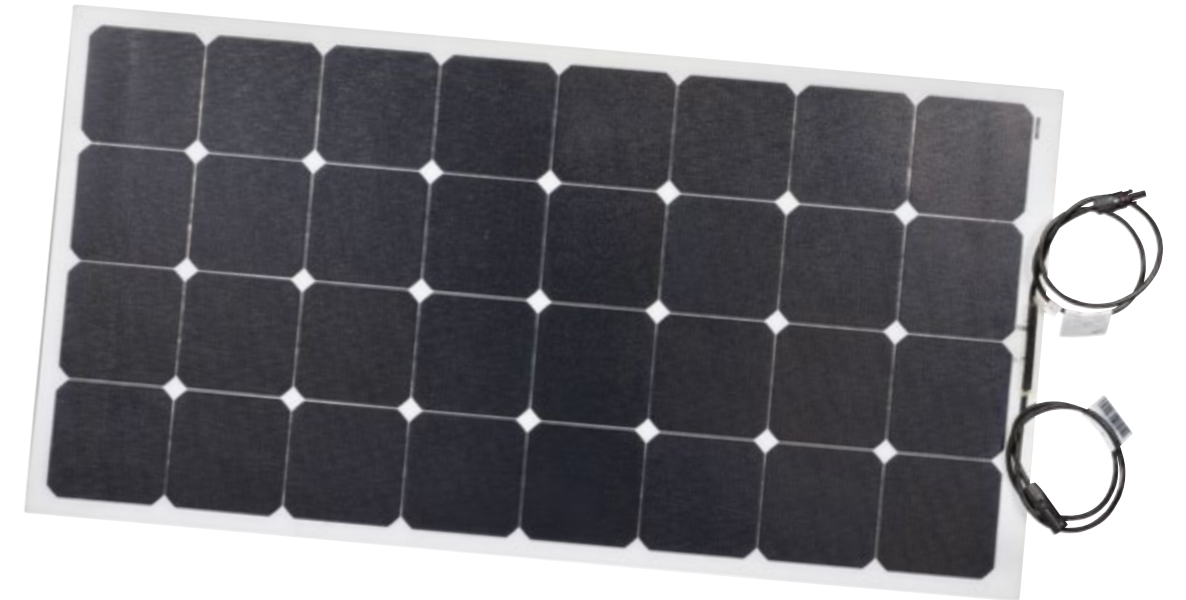

**PROJECTA MONOCRYSTALLINE 180W SEMI FLEXIBLE SOLAR PANEL**

Made for permanent mounting on surfaces that have a slight contour or curve. It will suit applications where power is required to charge battery banks servicing multiple or large appliances.

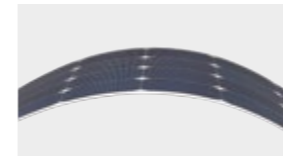

**LIGHTWEIGHT & FLEXIBLE**  
The panels weigh as little as 3.5kgs, being flexible also gives greater mounting options.

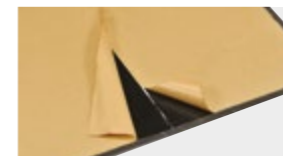

**PRE-APPLIED ADHESIVE**  
The panels come supplied with a super tough adhesive allowing users to mount them with confidence.



**MC4 TYPE CONNECTOR**  
Standardised MC4 type connector fitted for ease of installation.

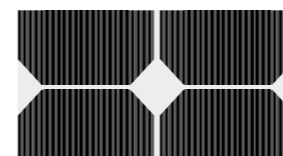

**HIGH PERFORMANCE**  
Super efficient monocrystalline technology produces more power via a smaller sized panel to effectively maintain a battery.

SPECIFICATIONS	
PART NO.	SPF180
TYPE	Monocrystalline
RATED POWER	180W (12V)
OPEN CIRCUIT VOLTAGE	24.1V
SHORT CIRCUIT CURRENT	9.2A
PEAK POWER VOLTAGE	20.5V
PEAK POWER CURRENT	8.8A
MAXIMUM BENDING RADIUS	400mm
TEST CONDITIONS	1000W/m <sup>2</sup> , 25°C
WEIGHT	3.5kg
BATTERY CHARGE TIMES	
AUTOMOTIVE	300-1300CCA
MARINE	400-2000MCA
DEEP CYCLE	50-240Ah
CHARGING TIME	7-35 hours

**2 YEAR WARRANTY**

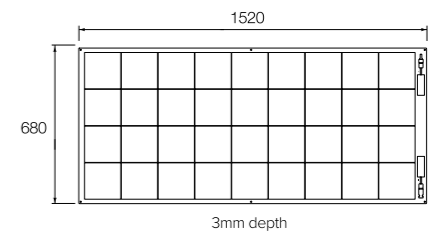

SOLAR PANELS

# WHY MONO VS POLY?

## WHAT ARE POLY & MONO SOLAR PANELS AND WHAT ARE THE DIFFERENCES BETWEEN THEM?

Polycrystalline, often referred to as Poly, is referring to the solar cell type. Polycrystalline cells are made from a wide array of silicone fragments melted together to form the wafers for the solar cells.

Monocrystalline, often referred to as Mono, is also referring to the solar cell type. Monocrystalline cells are made from a single-crystal silicone melted together to form into bars and cut into the wafers to form solar cells.

Monocrystalline solar panels are more efficient due to their cell construction. Due to the single-crystal silicone construction, the cells allow electrons generated by the sun's power to move more efficiently through the cells which in turn allows more power to be generated.

**SOLAR CELL TYPES**

**MONO**  
To make cells for monocrystalline panels silicone is formed into bars and cut into wafers. They are more expensive but more efficient.

**POLY**  
To make cells for polycrystalline panels fragments of silicone are melted to form the wafers. They are less expensive but less efficient.

SOLAR CONTROLLERS

# WHY MPPT OVER PWM?

## TO UNDERSTAND WHY MPPT SOLAR CONTROLLERS OVER PWM SOLAR CONTROLLERS, WE FIRST NEED TO UNDERSTAND WHAT THE TWO CONTROL METHODS ARE.

PWM stands for Pulse Width Modulation. PWM controllers method of charging is rather basic; it behaves as a quick on/off switch to maintain a desired voltage to charge batteries from a solar input.

MPPT stands for Maximum Power Point Tracking. MPPT controllers method is more sophisticated; the controller will monitor various inputs from solar panels and it will constantly measure the voltage and amperage to find the best balance to produce the most power.

Now that we understand the difference between PWM and MPPT solar controllers, we can dive into why a MPPT solar controller is a better choice in harnessing the most power out of a solar setup.

MPPT controllers typically have a 30% charge efficiency advantage over PWM type controllers. PWM controllers are best suited to setups with solar power output greater than the charging amperage required. MPPT controllers are suited to larger panels that provide power to large appliances and batteries. The MPPT controller takes into account temperature, voltage and amperage to provide the optimal power output, additionally MPPT controllers have greater flexibility with the input voltages of panels.

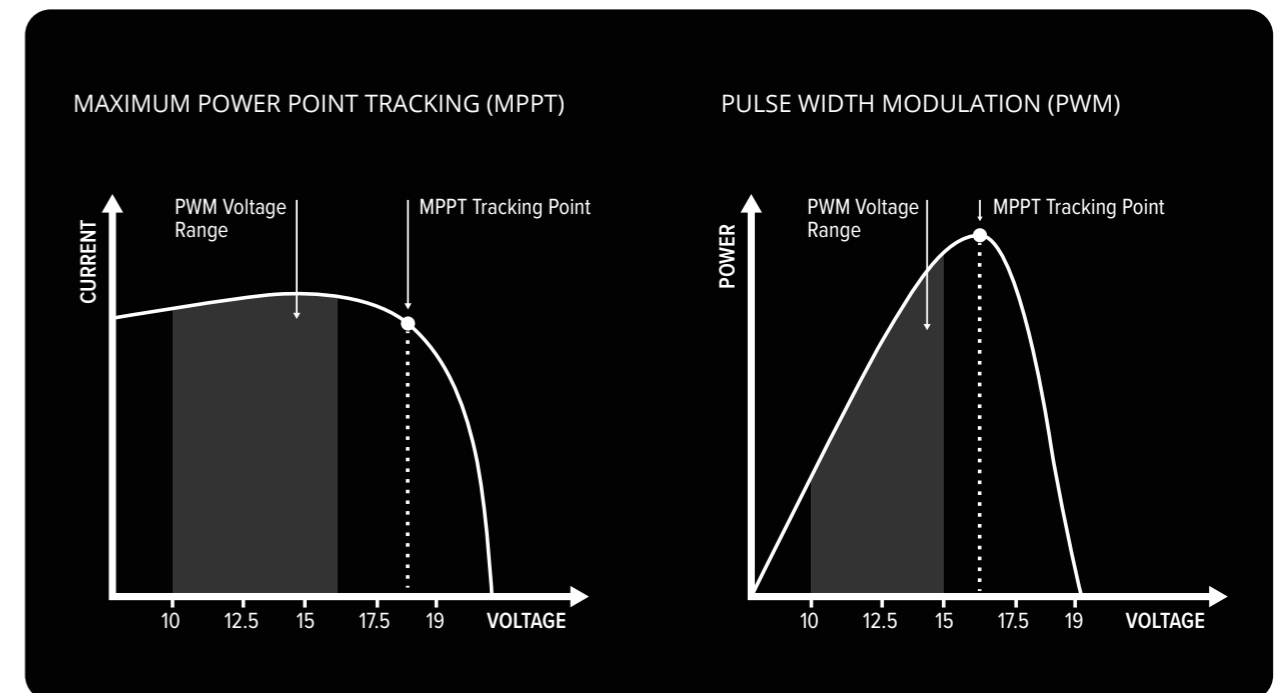

PROJECTA

# SOLAR CONTROLLERS

## TAKING CHARGE OF THE SUN.

Solar panels capture the sunlight converting it to useable electric power, however without a solar controller to regulate this power it will ultimately damage batteries through excessive charge and even discharge at night. Projecta offers an extensive range of automatic solar charge controllers to suit a wide range of solar applications, all with varying amperage ratings. Each of the controllers can be left connected indefinitely to the battery keeping it fully charged, monitoring its condition and performing a process called 'float' charge to keep batteries in optimum condition, ultimately ensuring longer life.



**PROJECTA**



EVERYDAY RANGE

SMART RANGE



PREMIUM RV RANGE

MPPT RANGE

## FEATURES & BENEFITS

### EVERYDAY CONTROLLERS



Simple yet intelligent solar charge controllers that utilise a smart 4 stage charging algorithm to ensure a thorough and comprehensive charge. Ideal for managing both automotive and deep cycle batteries thanks to their multi-chemistry functionality.

### SMART CONTROLLERS



Suitable for both 12 and 24 Volt systems they also offer low voltage disconnect (LVD) functionality ensuring connected batteries never deplete to damaging levels. Further to this, they offer a 'load control' function, enabling on/off control of appliances directly from the unit.

### PREMIUM RV CONTROLLERS



Featuring sophisticated 4 stage charging and all the features of the smart controller range, they step it up a level with the inclusion of an intelligent remote control unit that enables complete user control via total customisation of the charge settings.

### MPPT CONTROLLERS



MPPT solar controllers are ideal for RV fitment. Featuring advanced multi-chemistry charging to ensure all battery types are catered for. MPPT controllers ensure solar panels achieve their full capability via sophisticated programming in adjusting voltage & current to provide maximum output.

## SOLAR WIRING GUIDE

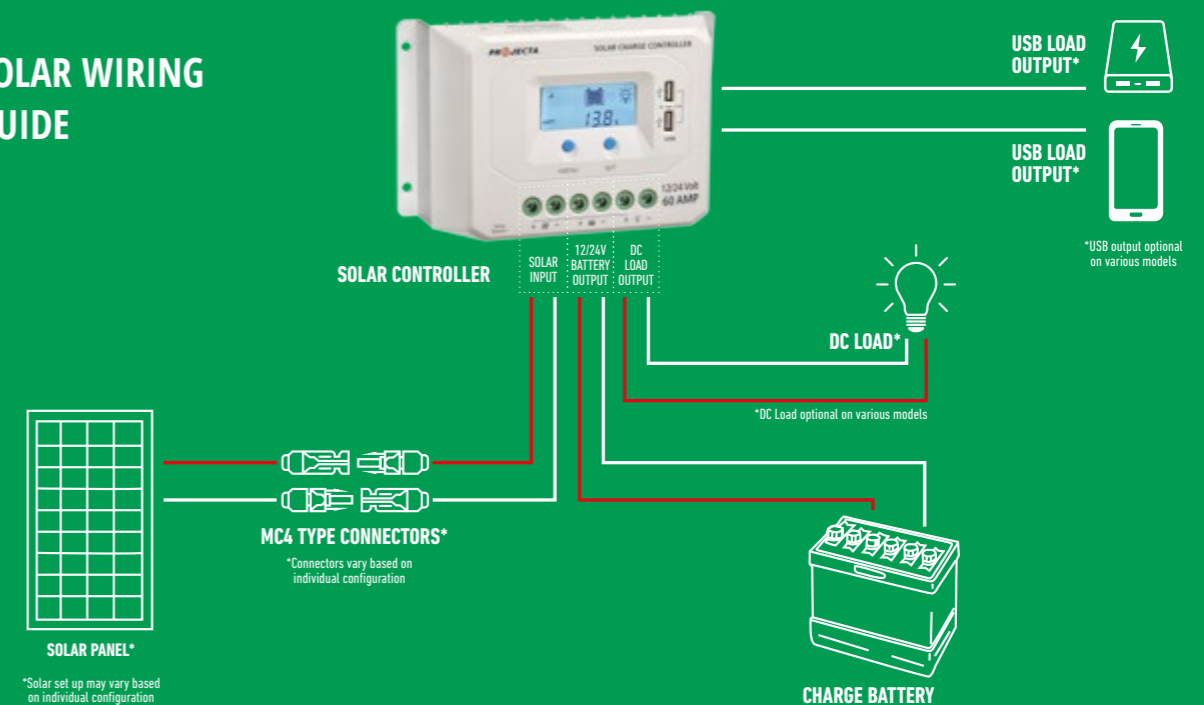

## WHY MULTI-STAGE CHARGE CONTROLLERS?

A solar panel charge controller in basic terms works no differently to maintaining batteries via a battery charger from 240 volts, the obvious advantages however are that this can be done whilst off the grid which is perfect for the avid traveller who enjoys remote locations. Perhaps one of the more important features to take note of is the multi-stage charging function on offer. All Projecta solar controllers utilise a sophisticated 4 stage charging algorithm offering unparalleled charging performance ultimately extending daily performance and overall battery life – a feature worth noting when factoring in the cost of today's expensive deep cycle batteries.

The table to the right details the four stages of the charging process.

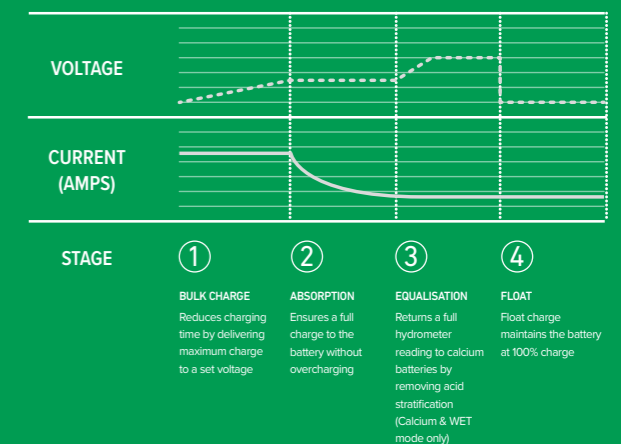

8 AMP  
12 VOLT



**PROJECTA  
8 AMP EVERYDAY CONTROLLER  
4 STAGE AUTOMATIC SOLAR CHARGE**

Safe to leave permanently connected, these compact solar controllers feature advanced 4 stage charging making them ideal for both starting and deep cycle batteries.



**L.E.D CHARGE INDICATOR**  
Displays quick reference to charge status of the battery.



**SEALED ELECTRONICS**  
Potted circuit board and plated terminals protect controller from the elements.



**EASE OF CONNECTION**  
Plated screw termination and quick reference label.



**MULTI-CHEMISTRY**  
Set the charging profile to suit battery chemistry type: Wet, Calcium, AGM or Gel.

**SPECIFICATIONS**

PART NO.	SC008
INPUT	12V
MAX INPUT	25Vdc, 8A
MAX CHARGE	8A
MAX PANEL SIZE	96W (12V)
BATTERY	12V
CHARGE CONTROL	4 Stage Charging 12V
Bulk:	14.0V
Absorption:	Gel 14.1V
	AGM 14.4V
	Wet 14.7V
	Calcium 14.9V
Equalisation:	15.5V
Float:	13.6V
APPROVAL	EMC
IP RATING	IP65

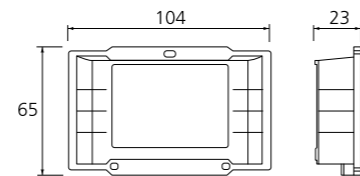

15 AMP  
12 VOLT



**PROJECTA  
15 AMP EVERYDAY CONTROLLER  
4 STAGE AUTOMATIC SOLAR CHARGE**

A compact controller suitable for solar panels producing up to 15 Amps. Utilising an advanced 4 stage charging profile, this controller ensures both starting and deep cycle batteries are kept in peak condition.



**L.E.D CHARGE INDICATOR**  
Displays quick reference to charge status of the battery .



**SEALED ELECTRONICS**  
Potted circuit board and plated terminals protect controller from the elements.



**EASE OF CONNECTION**  
Plated screw termination and quick reference label.



**MULTI-CHEMISTRY**  
Set the charging profile to suit battery chemistry type: Wet, Calcium, AGM or Gel.

**SPECIFICATIONS**

PART NO.	SC015
INPUT	12V
MAX INPUT	25Vdc, 15A
MAX CHARGE	15A
MAX PANEL SIZE	180W (12V)
BATTERY	12V
CHARGE CONTROL	4 Stage Charging 12V
Bulk:	14.0V
Absorption:	Gel 14.1V
	AGM 14.4V
	Wet 14.7V
	Calcium 14.9V
Equalisation:	15.5V
Float:	13.6V
APPROVAL	EMC
IP RATING	IP65

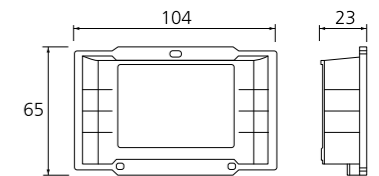

10 AMP  
12 VOLT



LITHIUM  
BATTERY COMPATIBLE

**PROJECTA  
10 AMP EVERYDAY PLUS CONTROLLER  
4 STAGE AUTOMATIC SOLAR CHARGE**

Packed with features, this sophisticated solar controller is ideal for panels capable of producing up to 10 Amps. Delivering a comprehensive 4 stage charging process and the ability to tailor its settings to best suit the selected battery type.

SPECIFICATIONS	
PART NO.	SC110
INPUT	12V
MAX INPUT	25Vdc, 10A
MAX CHARGE	10A
MAX PANEL SIZE	120W (12V)
BATTERY	12V
CHARGE CONTROL	4 Stage Charging 12V
	Bulk: 10.0-14.0V
	Absorption: Gel 14.1V
	AGM 14.4V
	Wet 14.7V
	Calcium 14.9V
	Lithium 14.4V
	Equalisation: 15.5V
	Float: 13.6V
APPROVAL	EMC
IP RATING	IP22



**DIGITAL LCD SCREEN**  
Displays battery voltage, charging current, charging capacity, fault codes and more.



**L.E.D CHARGE INDICATOR**  
Displays quick reference to charge status and battery condition.



**MULTI-CHEMISTRY**  
Set the charging profile to suit battery chemistry type: Wet, Calcium, AGM, Gel or Lithium.



**EASE OF CONNECTION**  
Plated screw termination and quick reference label.



**TEMPERATURE SENSOR**  
Built-in sensor enables unit to optimise charge performance and offer additional protection. Optional sensor probe also available.

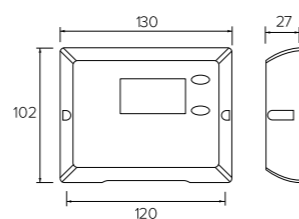

**OPTIONAL ACCESSORIES**  
SC1TMP EXTERNAL TEMPERATURE SENSOR PROBE

20 AMP  
12 / 24 VOLT



**PROJECTA  
20 AMP SMART CONTROLLER  
4 STAGE AUTOMATIC SOLAR CHARGE**

Ideally suited to solar panels producing up to 20 Amps, the SC220 is a sophisticated solar controller that delivers a comprehensive 4 stage charging process and the ability to tailor its settings to best suit the selected battery type.

SPECIFICATIONS	
PART NO.	SC220
INPUT	12 or 24V
MAX INPUT	50Vdc, 20A
MAX CHARGE/LOAD	20A
MAX PANEL SIZE	240W (12V)
BATTERY	12V or 24V
CHARGE CONTROL	4 Stage Charging 12V 24V
	Bulk/Absorption: Gel 14.2V 28.4V
	AGM 14.4V 28.8V
	Wet 14.7V 29.4V
	Equalisation: Gel - -
	AGM 14.6V 29.2V
	Wet 14.8V 29.6V
	Float: 13.8V 27.6V
NEGATIVE SWITCHING	Yes
LVD DISCONNECT	12V: Default 11.1V User Set 9-17V
	24V: Default 22.2V User Set 18-34V
LVD RECONNECT	12V: Default 12.6V User Set 9-17V
	24V: Default 25.2V User Set 18-34V
APPROVAL	EMC
IP RATING	IP22



**DIGITAL LCD SCREEN**  
Displays battery voltage, charging current, charging capacity, fault codes and more.



**DUAL USB PORTS**  
5V 2.4A USB ports for powering direct from controller.



**MULTI-CHEMISTRY**  
Set the charging profile to suit battery chemistry type: Wet, AGM or Gel, or user settings.



**LOW VOLTAGE DISCONNECT**  
Set the disconnect voltage point to best suit your application, protecting your battery from over discharge.



**TEMPERATURE SENSOR**  
Built-in sensor enables unit to optimise charge performance and offer additional protection. Optional sensor probe also available.

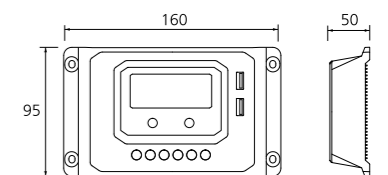

**OPTIONAL ACCESSORIES**  
SC3TMP EXTERNAL TEMPERATURE SENSOR PROBE



45 AMP  
12 / 24 VOLT



**PROJECTA**  
**45 AMP SMART CONTROLLER**  
**4 STAGE AUTOMATIC SOLAR CHARGE**

Ideal for larger deep cycle battery banks often found in motor homes, houseboats and remote shacks. This sophisticated controller boasts a host of intelligent features enabling the user to customise the charge settings to maximise battery life and performance.



**DIGITAL LCD SCREEN**  
Displays battery voltage, charging current, charging capacity, fault codes and more.



**DUAL USB PORTS**  
5V 2.4A USB ports for powering direct from controller.



**MULTI-CHEMISTRY**  
Set the charging profile to suit battery chemistry type: Wet, AGM or Gel, or user settings.



**LOW VOLTAGE DISCONNECT**  
Set the disconnect voltage point to best suit your application, protecting your battery from over discharge.



**TEMPERATURE SENSOR**  
Built-in sensor enables unit to optimise charge performance and offer additional protection. Optional sensor probe also available.

SPECIFICATIONS			
PART NO.	SC245		
INPUT	12 or 24V		
MAX INPUT	50Vdc, 45A		
MAX CHARGE/LOAD	45A		
MAX PANEL SIZE	540W (12V)		
BATTERY	12V or 24V		
CHARGE CONTROL	4 Stage Charging	12V	24V
	Bulk/Absorption:	Gel	14.2V 28.4V
		AGM	14.4V 28.8V
		Wet	14.7V 29.4V
	Equalisation:	Gel	- -
		AGM	14.6V 29.2V
	Wet	14.8V 29.6V	
Float:	13.8V 27.6V		
NEGATIVE SWITCHING	Yes		
LVD DISCONNECT	12V: Default 11.1V	User Set 9-17V	
	24V: Default 22.2V	User Set 18-34V	
LVD RECONNECT	12V: Default 12.6V	User Set 9-17V	
	24V: Default 25.2V	User Set 18-34V	
APPROVAL	EMC		
IP RATING	IP22		

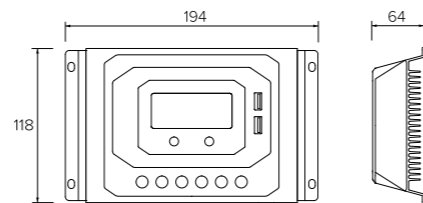

**OPTIONAL ACCESSORIES**  
**SC3TMP** EXTERNAL TEMPERATURE SENSOR PROBE

PRODUCT CODE  
**SC245**

60 AMP  
12 / 24 VOLT

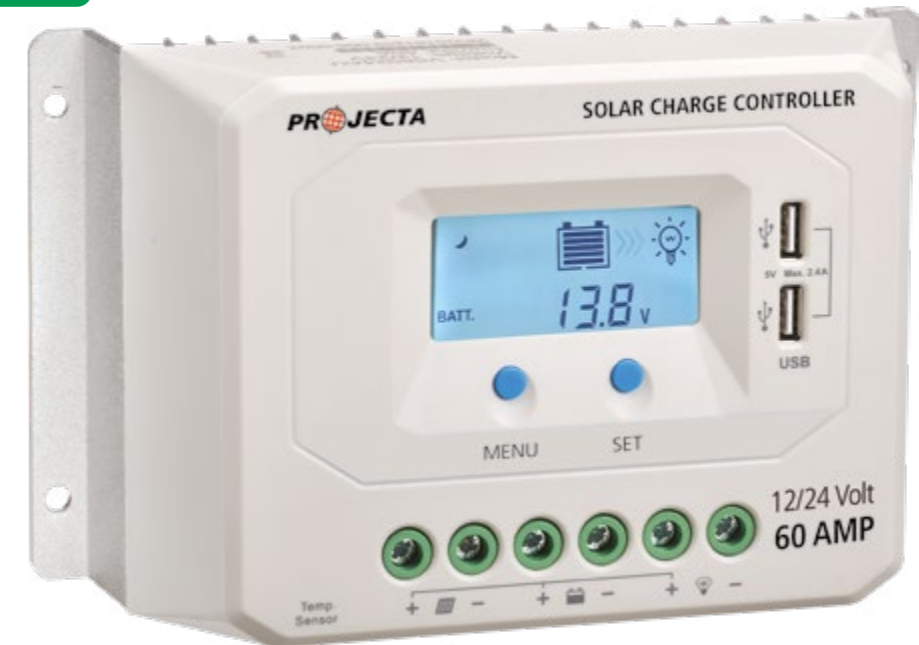

**PROJECTA**  
**60 AMP SMART CONTROLLER**  
**4 STAGE AUTOMATIC SOLAR CHARGE**

Ideal for larger deep cycle battery banks often found in motor homes, houseboats and remote shacks. This sophisticated controller boasts a host of intelligent features enabling the user to customise the charge settings to maximise battery life and performance.



**DIGITAL LCD SCREEN**  
Displays battery voltage, charging current, charging capacity, fault codes and more.



**DUAL USB PORTS**  
5V 2.4A USB ports for powering direct from controller.



**MULTI-CHEMISTRY**  
Set the charging profile to suit battery chemistry type: Wet, AGM or Gel, or user settings.



**LOW VOLTAGE DISCONNECT**  
Set the disconnect voltage point to best suit your application, protecting your battery from over discharge.



**TEMPERATURE SENSOR**  
Built-in sensor enables unit to optimise charge performance and offer additional protection. Optional sensor probe also available.

SPECIFICATIONS			
PART NO.	SC260		
INPUT	12 or 24V		
MAX INPUT	50Vdc, 60A		
MAX CHARGE/LOAD	60A		
MAX PANEL SIZE	720W (12V)		
BATTERY	12V or 24V		
CHARGE CONTROL	4 Stage Charging	12V	24V
	Bulk/Absorption:	Gel	14.2V 28.4V
		AGM	14.4V 28.8V
		Wet	14.7V 29.4V
	Equalisation:	Gel	- -
		AGM	14.6V 29.2V
	Wet	14.8V 29.6V	
Float:	13.8V 27.6V		
NEGATIVE SWITCHING	Yes		
LVD DISCONNECT	12V: Default 11.1V	User Set 9-17V	
	24V: Default 22.2V	User Set 18-34V	
LVD RECONNECT	12V: Default 12.6V	User Set 9-17V	
	24V: Default 25.2V	User Set 18-34V	
APPROVAL	EMC		
IP RATING	IP22		

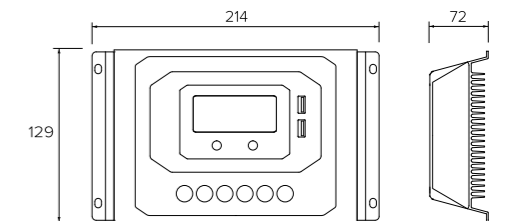

**OPTIONAL ACCESSORIES**  
**SC3TMP** EXTERNAL TEMPERATURE SENSOR PROBE

PRODUCT CODE  
**SC260**

**20 AMP**  
12 / 24 VOLT



**PROJECTA**  
**20 AMP PREMIUM RV**  
**4 STAGE AUTOMATIC SOLAR CHARGE CONTROLLER**  
**WITH REMOTE CONTROL**

The ideal controller to suit panels producing up to 20A, often found in caravans. The sophisticated remote control provides total user control and advanced operation and allows the user to set a tailored charging profile and monitor battery and charging status.



**MULTI-CHEMISTRY**  
Set the charging profile to suit battery chemistry type: Wet, AGM or Gel, or user settings.

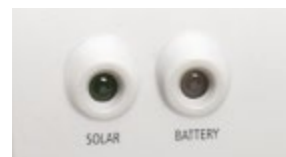

**L.E.D STATUS INDICATORS**  
Displays quick reference to charge and battery status.



**MANUAL LOAD CONTROL**  
Allows user to switch the DC load on/off from the controller itself



**TEMPERATURE SENSOR**  
Built-in sensor enables unit to optimise charge performance and offer additional protection. Optional sensor probe also available.



**LOW VOLTAGE DISCONNECT**  
Set the disconnect voltage point to best suit your application, protecting your battery from over discharge.

SPECIFICATIONS			
PART NO.	SC320D		
INPUT	12V or 24V		
MAX INPUT	50Vdc, 20A		
MAX CHARGE/LOAD	20A		
MAX PANEL SIZE	240W (12V)		
LOAD SWITCHING	Negative		
BATTERY	12V or 24V		
CHARGE CONTROL	4 Stage Charging	12V	24V
	Bulk/ Absorption:	Gel	14.2V 28.4V
		AGM	14.4V 28.8V
		Wet	14.6V 29.2V
	Equalisation:	Gel	- -
		AGM	14.6V 29.2V
		Wet	14.8V 29.6V
Float:	13.8V	27.6V	
LVD DISCONNECT	12V: Default 11.1V	User Set 9-17V	
	24V: Default 22.2V	User Set 18-34V	
LVD RECONNECT	12V: Default 12.6V	User Set 9-17V	
	24V: Default 25.2V	User Set 18-34V	
STANDBY CURRENT	23.4mA		
APPROVALS	EMC		

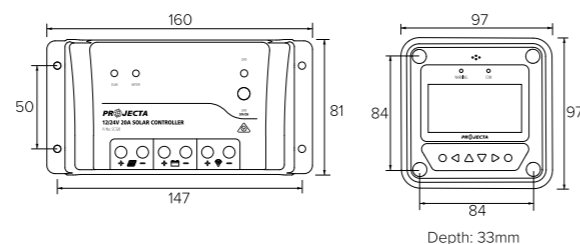

**OPTIONAL ACCESSORIES**  
SC3TMP EXTERNAL TEMPERATURE SENSOR PROBE  
**REPLACEMENT PARTS**  
SC320 SOLAR CHARGE CONTROLLER ONLY  
SC300D REMOTE CONTROL ONLY

**30 AMP**  
12 / 24 VOLT



**PROJECTA**  
**30 AMP PREMIUM RV**  
**4 STAGE AUTOMATIC SOLAR CHARGE CONTROLLER**  
**WITH REMOTE CONTROL**

The ideal controller to suit the demands of larger power requirements often found in motor homes, house boats or remote shacks. The sophisticated remote control provides complete control, allowing the user to set a tailored charging profile and monitor battery and charging status.



**MULTI-CHEMISTRY**  
Set the charging profile to suit battery chemistry type: Wet, AGM or Gel, or user settings.



**L.E.D STATUS INDICATORS**  
Displays quick reference to charge and battery status.



**MANUAL LOAD CONTROL**  
Allows user to switch the DC load on/off from the controller itself.



**TEMPERATURE SENSOR**  
Built-in sensor enables unit to optimise charge performance and offer additional protection. Optional sensor probe also available.



**LOW VOLTAGE DISCONNECT**  
Set the disconnect voltage point to best suit your application, protecting your battery from over discharge.

SPECIFICATIONS			
PART NO.	SC330D		
INPUT	12V or 24V		
MAX INPUT	50Vdc, 30A		
MAX CHARGE/LOAD	30A		
MAX PANEL SIZE	360W (12V)		
LOAD SWITCHING	Negative		
BATTERY	12V or 24V		
CHARGE CONTROL	4 Stage Charging	12V	24V
	Bulk/ Absorption:	Gel	14.2V 28.4V
		AGM	14.4V 28.8V
		Wet	14.6V 29.2V
	Equalisation:	Gel	- -
		AGM	14.6V 29.2V
		Wet	14.8V 29.6V
Float:	13.8V	27.6V	
LVD DISCONNECT	12V: Default 11.1V	User Set 9-17V	
	24V: Default 22.2V	User Set 18-34V	
LVD RECONNECT	12V: Default 12.6V	User Set 9-17V	
	24V: Default 25.2V	User Set 18-34V	
STANDBY CURRENT	23.4mA		
APPROVALS	EMC		

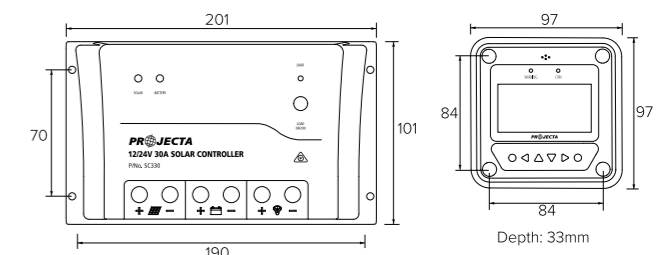

**OPTIONAL ACCESSORIES**  
SC3TMP EXTERNAL TEMPERATURE SENSOR PROBE  
**REPLACEMENT PARTS**  
SC330 SOLAR CHARGE CONTROLLER ONLY  
SC300D REMOTE CONTROL ONLY

20 AMP  
12 / 24 VOLT

NEW



LITHIUM  
BATTERY COMPATIBLE

**PROJECTA  
20 AMP PREMIUM RV  
MPPT AUTOMATIC SOLAR CHARGE  
CONTROLLERS**

The 20A are the ideal controllers to make the most out of solar panels. Ideally suited to caravans and RVs, these sophisticated MPPT solar controllers ensure a solar system is delivering the optimal power to meet a wide range of power demands.



**MULTI-CHEMISTRY**  
Set the charge profile to suit battery types; Wet, AGM, GEL or Lithium.

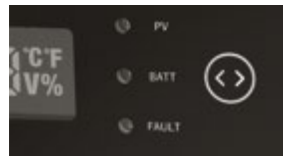

**SLEEK DESIGN**  
Touch screen buttons and bright screen ensures the controller looks great no matter where it's placed.



**SOLAR CONTROLLER**  
98.2% efficient MPPT (Maximum Power Point Tracking) solar controller maximizes the sun's radiation and converts it to power.



**TEMPERATURE SENSOR**  
Plug-in sensor enables unit to optimise charge performance and offer additional protection.



**PREMIUM QUALITY**  
Tempered glass cover with housing made from cast aluminium providing premium feel with silent operation.

SPECIFICATIONS			
PART NO.	SC420		
INPUT	12V or 24V		
MAX INPUT	100Vdc, 20A		
MAX CHARGE/LOAD	20A		
MAX PANEL SIZE	300W (12V) / 600W (24V)		
LOAD SWITCHING	Negative		
BATTERY	12V or 24V		
CHARGE CONTROL	4 Stage Charging	12V	24V
		Bulk/ Absorption:	Gel 14.2V 28.4V
	Equalisation:	AGM 14.4V 28.8V	
		Wet 14.6V 29.2V	
		Lithium 14.2V 28.4V	
		Gel - -	
	Float:	AGM 14.6V 29.2V	
		Wet 14.8V 29.6V	
		Lithium - -	
		Gel - -	
	AGM 13.8V 27.6V		
	Wet - -		
Lithium - -			
STANDBY CURRENT	12mA		
APPROVAL	EMC		
IP RATING	IP34		

2  
YEAR  
WARRANTY

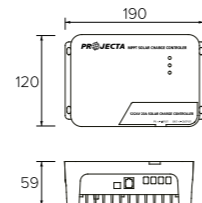

**OPTIONAL ACCESSORIES**  
SC400D REMOTE CONTROL DISPLAY  
REPLACEMENT PARTS  
SC4TMP EXTERNAL TEMPERATURE SENSOR PROBE

PRODUCT CODE  
SC420

40 AMP  
12 / 24 VOLT

NEW



LITHIUM  
BATTERY COMPATIBLE

**PROJECTA  
40 AMP PREMIUM RV  
MPPT AUTOMATIC SOLAR CHARGE  
CONTROLLERS**

The 40A is ideal for solar systems that are larger and require faster charging. Ideally suited to larger caravans and RVs, these sophisticated MPPT solar controllers ensure a solar system is delivering the optimal power to meet a wide range of power demands.



**MULTI-CHEMISTRY**  
Set the charge profile to suit battery types; Wet, AGM, GEL or Lithium.

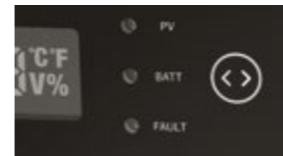

**SLEEK DESIGN**  
Touch screen buttons and bright screen ensures the controller looks great no matter where it's placed.



**SOLAR CONTROLLER**  
98.2% efficient MPPT (Maximum Power Point Tracking) solar controller maximizes the sun's radiation and converts it to power.



**TEMPERATURE SENSOR**  
Plug-in sensor enables unit to optimise charge performance and offer additional protection.



**PREMIUM QUALITY**  
Tempered glass cover with housing made from cast aluminium providing premium feel with silent operation.

SPECIFICATIONS			
PART NO.	SC440		
INPUT	12V or 24V		
MAX INPUT	100Vdc, 20A		
MAX CHARGE/LOAD	40A		
MAX PANEL SIZE	600W (12V) / 1200W (24V)		
LOAD SWITCHING	Negative		
BATTERY	12V or 24V		
CHARGE CONTROL	4 Stage Charging	12V	24V
		Bulk/ Absorption:	Gel 14.2V 28.4V
	Equalisation:	AGM 14.4V 28.8V	
		Wet 14.6V 29.2V	
		Lithium 14.2V 28.4V	
		Gel - -	
	Float:	AGM 14.6V 29.2V	
		Wet 14.8V 29.6V	
		Lithium - -	
		Gel - -	
	AGM 13.8V 27.6V		
	Wet - -		
Lithium - -			
STANDBY CURRENT	10mA		
APPROVAL	EMC		
IP RATING	IP34		

2  
YEAR  
WARRANTY

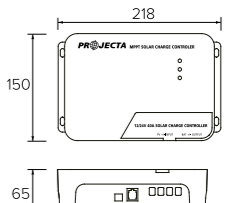

**OPTIONAL ACCESSORIES**  
SC400D REMOTE CONTROL DISPLAY  
REPLACEMENT PARTS  
SC4TMP EXTERNAL TEMPERATURE SENSOR PROBE

PRODUCT CODE  
SC440

20 AMP  
12 / 24 / 48 VOLT

INTELLI RANGE



NEW



LITHIUM  
BATTERY COMPATIBLE

**PROJECTA  
20 AMP PREMIUM RV  
12~48V MPPT WITH 100V SOLAR CHARGE  
CONTROLLER**

Get the most out of a solar array using these Maximum Power Point Tracking (MPPT) solar controllers increasing the charging output by up to 30% (compared to PWM Solar controllers).

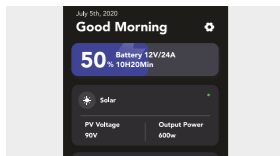

**BLUETOOTH**  
Bluetooth connectivity provides solar charging information remotely via smart phone.



**HIGH CURRENT CHARGING**  
20A model for high current charging.



**SOLAR INPUT**  
100V open circuit voltage allows for solar panels to be wired in series for maximum efficiency.



**SOLAR CONTROLLER**  
98.2% efficient MPPT (Maximum Power Point Tracking) solar controller maximizes the sun's radiation and converts it to power.



**MULTI-CHEMISTRY**  
Set the charging profile to suit battery chemistry type: Wet, AGM or Gel, or Lithium.

3  
YEAR  
WARRANTY

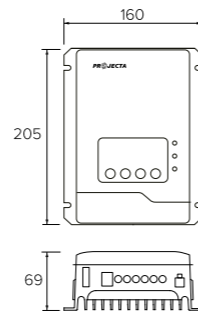

SPECIFICATIONS	
PART NO.	SC520
BATTERY VOLTAGE	12 / 24 / 48V
MAXIMUM SOLAR VOLTAGE	100V
STANDBY CURRENT	1mA at 12V 3mA at 24V 5mA at 48V
CHARGE TYPE	5 Stage
INPUT	100V
OUTPUT	20A
CONTROL TYPE	MPPT
BATTERIES SUPPORTED	Gel, AGM, Wet, Lithium
TEMPERATURE COMPENSATION	-18mV/12V
COMMUNICATION	Bluetooth, RS485
STORAGE TEMPERATURE	-40~70°C
HUMIDITY	5~95%
IP RATING	IP31
WEIGHT	1.4kg
COOLING	Convection
APPROVAL	EMC

20 AMP  
12 / 24 / 48 VOLT

INTELLI RANGE



NEW



LITHIUM  
BATTERY COMPATIBLE

**PROJECTA  
40 AMP PREMIUM RV  
12~48V MPPT WITH 100V SOLAR CHARGE  
CONTROLLER**

This premium 40Amp, 100V input solar controller used for large solar arrays is the perfect Maximum Power Point Tracking (MPPT) controller ideal for high end installations.

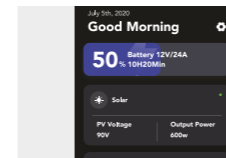

**BLUETOOTH**  
Bluetooth connectivity provides solar charging information remotely via smart phone.



**HIGH CURRENT CHARGING**  
40A model for high current charging.



**SOLAR INPUT**  
100V open circuit voltage allows for solar panels to be wired in series for maximum efficiency.



**SOLAR CONTROLLER**  
98.2% efficient MPPT (Maximum Power Point Tracking) solar controller maximizes the sun's radiation and converts it to power.



**MULTI-CHEMISTRY**  
Set the charging profile to suit battery chemistry type: Wet, AGM or Gel, or Lithium.

3  
YEAR  
WARRANTY

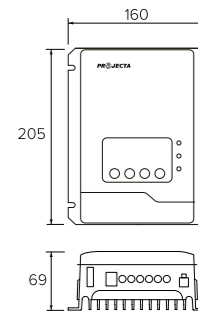

SPECIFICATIONS	
PART NO.	SC540
BATTERY VOLTAGE	12 / 24 / 48V
MAXIMUM SOLAR VOLTAGE	100V
STANDBY CURRENT	1mA at 12V 3mA at 24V 5mA at 48V
CHARGE TYPE	5 Stage
INPUT	100V
OUTPUT	40A
CONTROL TYPE	MPPT
BATTERIES SUPPORTED	Gel, AGM, Wet, Lithium
TEMPERATURE COMPENSATION	-18mV/12V
COMMUNICATION	Bluetooth, RS485
STORAGE TEMPERATURE	-40~70°C
HUMIDITY	5~95%
IP RATING	IP31
WEIGHT	1.4kg
COOLING	Convection
APPROVAL	EMC

**OPTIONAL ACCESSORIES**  
SC400D REMOTE CONTROL DISPLAY  
REPLACEMENT PARTS  
SC4TMP EXTERNAL TEMPERATURE SENSOR PROBE



**SA-50AHDC** (Blister 1)

**50A CONNECTOR TO BATTERY CLAMPS**

- 50Amp Heavy Duty Connector to 2 Insulated Battery Clamps with 8mm Battery Cable
- 300mm Length



**SA-50AHDRT** (Blister 1)

**50A CONNECTOR TO RING TERMINALS**

- 50Amp Heavy Duty Connector to 2 x 8mm Ring Terminals with 8mm Battery cable
- 300mm Length



**SA-50A12VI** (Blister 1)

**50A CONNECTOR TO ACCESSORY SOCKET**

- 50Amp Heavy Duty Connector to Accessory Socket
- 300mm Length



**SA-50A12VO** (Blister 1)

**50A CONNECTOR TO ACCESSORY PLUG**

- 50Amp Heavy Duty Connector to Accessory Plug
- 300mm Length



**SA-50A2A** (Blister 1)

**50A CONNECTOR TO TWIN 50A CONNECTORS**

- 50Amp Heavy Duty Connector to 2 x 50Amp Heavy Duty Connectors
- 600mm Length



**SA-50AMC4** (Blister 1)

**50A CONNECTOR TO MC4 TYPE CONNECTORS**

- 50Amp Heavy Duty Connector to MC4 type plug and socket
- 600mm Length



**SA-50AMC4L** (Blister 1)

**50A CONNECTOR TO MC4 TYPE CONNECTORS 5M EXTENSION LEAD**

- 50A Heavy Duty Connector to MC4 type Plug and Socket
- 5m Length



**SA-50AMC4RT** (Blister 1)

**MC4 TYPE CONNECTORS TO RING TERMINALS**

- MC4 type plug and socket to 2 x 8mm Ring Terminals
- 600mm Length



**MC4-2** (Blister 2)

**MC4 TYPE CONNECTORS**

- Single pin waterproof male & female connectors with terminals and seals
- With Pins



**MC4-F** (Blister 1)

**MC4 TYPE FEMALE CONNECTOR**

- Single pin waterproof female connector with terminal
- With Pins



**MC4-M** (Blister 1)

**MC4 TYPE MALE CONNECTOR**

- Single pin waterproof male connector with terminal and seal
- With Pins



**MC4-YN** (Blister 1)

**MC4 TYPE Y-LEAD NEGATIVE CONNECTOR**

- 2 Plugs to 1 Socket
- Negative termination



**MC4-YP** (Blister 1)

**MC4 TYPE Y-LEAD POSITIVE CONNECTOR**

- 2 Sockets to 1 Plug
- Positive termination



**SA-MRS** (Blister 2)

**SOLAR PANEL MOUNTING RAILS - 2 X SMALL**

- Dimensions (Length): 800mm x (Width): 40mm x (Height): 32mm
- Aluminium Material



**SA-MRL** (Blister 2)

**SOLAR PANEL MOUNTING RAILS - 2 X LARGE**

- Dimensions (Length): 800mm x (Width): 50mm x (Height): 42mm
- Aluminium Material

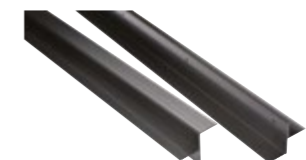



# SOLAR SOLUTIONS



**KT SOLAR**  
**5W, 12V MONOCRYSTALLINE**  
**SINGLE CELL SOLAR PANEL**

Designed for maintenance charging (trickle-charging) of 12V lead acid batteries that power garden lighting and 12V water pumps.

- Can be used unregulated (without solar controller)
- Direct connection to batteries with 3M PV cables with positive (+) & negative (-) alligator clamps
- Dimensions (mm): 290 (H) x 160 (W) x 17 (D)
- Weight (Kg): 0.60

Power Tolerance	+3%
Maximum Power (Pmax)	5Wp
Maximum Power Voltage (Vmp)	18.0V
Maximum Power Current (Imp)	0.28A
Rated Voltage	12V
Open Circuit Voltage (Voc)	21.5V
Short Circuit Current (Isc)	0.30A
Operating Temperature	-40°C to +85°C
Product Application	Class A
Max System Voltage	1000V DC

RECOMMENDED APPLICATIONS



MANUFACTURING STANDARDS



PRODUCT CODE  
**KT70714**



**KT SOLAR**  
**10W, 12V MONOCRYSTALLINE**  
**SINGLE CELL SOLAR PANEL**

Designed for maintenance charging (trickle-charging) of 12V lead acid batteries that power garden lighting and 12V water pumps.

- Can be used unregulated (without solar controller)
- Direct connection to batteries with 3M PV cables with positive (+) & negative (-) alligator clamps
- Dimensions (mm): 355 (H) x 225 (W) x 17 (D)
- Weight (Kg): 1.10

Power Tolerance	+3%
Maximum Power (Pmax)	10Wp
Maximum Power Voltage (Vmp)	18.0V
Maximum Power Current (Imp)	0.56A
Rated Voltage	12V
Open Circuit Voltage (Voc)	21.5V
Short Circuit Current (Isc)	0.61A
Operating Temperature	-40°C to +85°C
Product Application	Class A
Max System Voltage	1000V DC

RECOMMENDED APPLICATIONS



MANUFACTURING STANDARDS



PRODUCT CODE  
**KT70715**

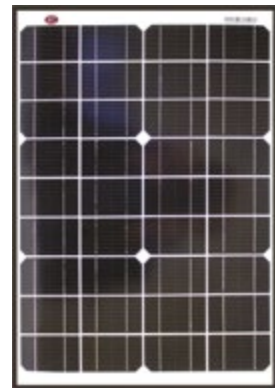

**KT SOLAR**  
**20W, 12V MONOCRYSTALLINE**  
**SINGLE CELL SOLAR PANEL**

Designed for maintenance charging (trickle-charging) of 12V lead acid batteries that power jet-skis, motorcycles, ride-on lawnmowers, surveillance camera systems, home irrigation systems, electric fences, electric gates and garden lighting.

- Requires regulation by solar charge controller
- Easy direct connection to batteries with 3M PV cables with pos (+) & neg (-) alligator clamps
- Dimensions (mm): 483 (H) x 343 (W) x 17 (D)
- Weight (Kg): 1.80

Power Tolerance	+3%
Maximum Power (Pmax)	20Wp
Maximum Power Voltage (Vmp)	18.1V
Maximum Power Current (Imp)	1.11A
Rated Voltage	12V
Open Circuit Voltage (Voc)	21.6V
Short Circuit Current (Isc)	1.21A
Operating Temperature	-40°C to +85°C
Product Application	Class A
Max System Voltage	1000V DC

RECOMMENDED APPLICATIONS



MANUFACTURING STANDARDS



PRODUCT CODE  
**KT70716**

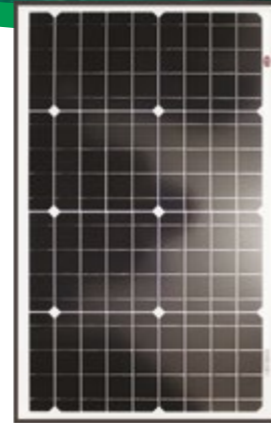

**KT SOLAR**  
**40W, 12V MONOCRYSTALLINE**  
**SINGLE CELL SOLAR PANEL**

Designed for maintenance charging (trickle-charging) 12V batteries. Ideal for installation on 4WDs, caravans, motorhomes, jettys for charging small 12V boat & jet-ski batteries. Ideal for 12V home surveillance systems, garden lighting, irrigation, electric fences and gates.

- Requires regulation by solar charge controller
- Connect to batteries with 900mm PV cables with pos (+) & neg (-) TUV certified female & male solar connectors
- Dimensions (mm): 420 (H) x 670 (W) x 25 (D)
- Weight (Kg): 3.20

Power Tolerance	+3%
Maximum Power (Pmax)	40Wp
Maximum Power Voltage (Vmp)	18.2V
Maximum Power Current (Imp)	2.19A
Rated Voltage	12V
Open Circuit Voltage (Voc)	21.6V
Short Circuit Current (Isc)	2.42A
Operating Temperature	-40°C to +85°C
Product Application	Class A
Max System Voltage	1000V DC

RECOMMENDED APPLICATIONS



MANUFACTURING STANDARDS



PRODUCT CODE  
**KT70717**



**KT SOLAR**  
**120W, 12V MONOCRYSTALLINE**  
**SINGLE CELL SOLAR PANEL**

Ideal for installation on 4WDs, caravans, campers, motorhomes, commercial vehicles, boats and yachts. Ideal for home and rural applications including 12V home surveillance systems, irrigation systems, electric fences / gates and off-grid shed power.

- Requires regulation by solar charge controller
- Direct connection to batteries with 900mm PV cables with positive pos (+) & neg (-) TUV certified female & male solar connectors
- Dimensions (mm): 945(H) x 670(W) x 35 (D)
- Weight (Kg): 6.90

Power Tolerance	+3%
Maximum Power (Pmax)	20Wp
Maximum Power Voltage (Vmp)	18.1V
Maximum Power Current (Imp)	1.11A
Rated Voltage	12V
Open Circuit Voltage (Voc)	21.6V
Short Circuit Current (Isc)	1.21A
Operating Temperature	-40°C to +85°C
Product Application	Class A
Max System Voltage	1000V DC

RECOMMENDED APPLICATIONS



MANUFACTURING STANDARDS



PRODUCT CODE  
**KT70728**



**KT SOLAR**  
**200W, 12V MONOCRYSTALLINE**  
**SINGLE CELL SOLAR PANEL**

Ideal for installation on 4WDs, caravans, campers, motorhomes, commercial vehicles, boats and yachts. Ideal for home & rural applications including off-grid shed power.

- Requires regulation by solar charge controller
- Direct connection to batteries with 900mm PV cables with positive pos (+) & neg (-) TUV certified female & male solar connectors
- Dimensions (mm): 1476 (H) x 670 (W) x 35 (D)
- Weight (Kg): 11.50

Power Tolerance	+3%
Maximum Power (Pmax)	40Wp
Maximum Power Voltage (Vmp)	18.2V
Maximum Power Current (Imp)	2.19A
Rated Voltage	12V
Open Circuit Voltage (Voc)	21.6V
Short Circuit Current (Isc)	2.42A
Operating Temperature	-40°C to +85°C
Product Application	Class A
Max System Voltage	1000V DC

RECOMMENDED APPLICATIONS



MANUFACTURING STANDARDS



PRODUCT CODE  
**KT70729**

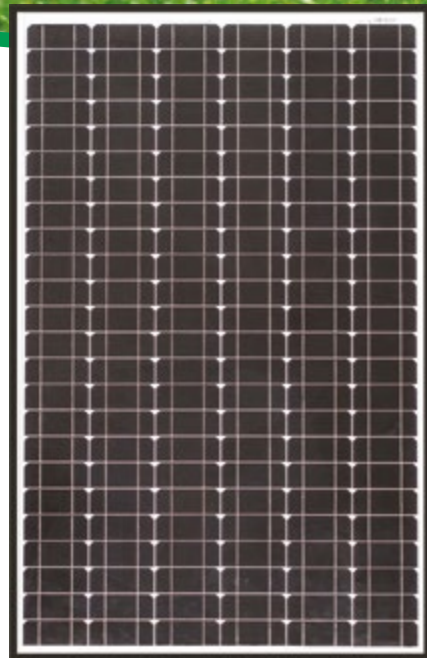

View the performance of your solar system while you are on or off the course easily via the Smartphone Application. Monitor Volts, Amps and Watts of your system in real time.



**KT SOLAR  
160W, 36-48V ELECTRIC VEHICLE  
SOLAR CHARGING SYSTEM**

This system is ideal for carts, service vehicles & resort electric vehicles operating on 36V and 48V Systems. This DIY, easy to install system features 'EZY' rails for mounting to your electric vehicles roof.

This solar charging system both maintains and extends battery life while reducing sulphur buildup & D.O.D (depth of discharge). This kit will reduce 240V charging time & the associated costs.

- Suits cart roofs of various popular models
- System voltage: 36-48V systems
- Premium MPPT Solar Controller (IP43 & IP22 Rated) with optional "real time" Volts/Amps/Watts visible via smartphone app
- Panel Dimensions (mm) : 1280 x 800 x 35
- Panel Weight (Kg): 11.8
- Five accreditation certificates
- Individually barcoded for warranty registration

**KIT INCLUDES**

- 1 x 160W Monocrystalline Solar Panel
- 1 x MPPT Solar Charge Controller
- 1 x Automatic reset 30A circuit breaker
- 1 x Red circuit breaker cover
- 2 x 50A Heavy duty connectors & handle
- 2M x 5mm twin sheath cable
- 2 x Insulated ring terminals, 6mm yellow
- 2 x Insulated ring terminals, 8mm yellow
- 3M x 10mm corrugated split loom tubing
- 2 x 20mm nylon cable glands
- 25 x Black cable ties
- 2 x EZY mounting rails, 800mm length

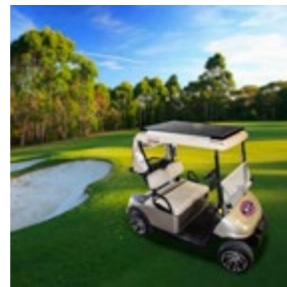

**WARRANTY**

- 10 Year Warranty / 25 year efficiency on solar panel
- 5 year warranty on MPPT solar controller
- 3 Year warranty on complete kit.

**RECOMMENDED APPLICATIONS**



**MANUFACTURING STANDARDS**



PRODUCT CODE  
**KT70777**

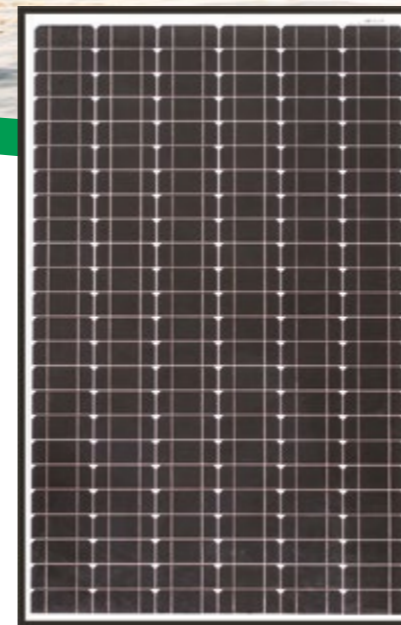
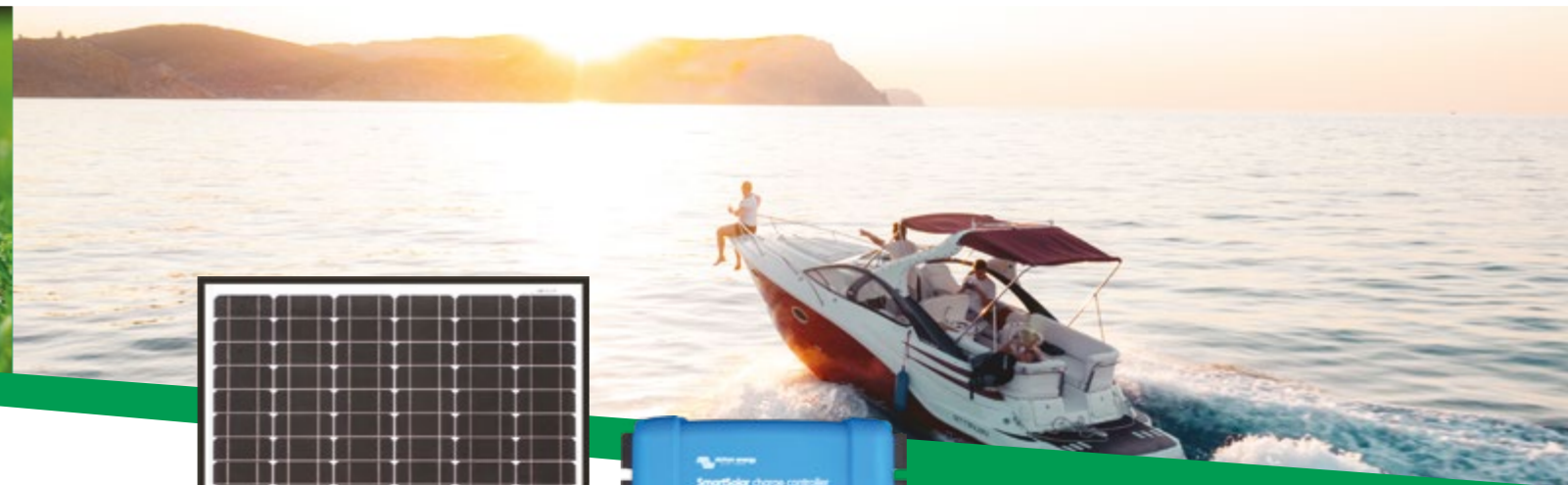

**KT SOLAR  
160W, 24-48V TRUCK, BUS & YACHT  
SOLAR CHARGING SYSTEM**

Designed & Innovated by KT Solar. This system is designed to suit prime mover truck cabin roofs, caravans, small commercial buses including Toyota Coasters and marine vessels.

This system works in conjunction with the Victron 100-20 MPPT Solar Controller. The Solar Panel is a higher nominal voltage than 24V, however the Victron controller automatically steps down to provide the correct voltage and current.

- Operates on 24-48V systems
- Premium MPPT 100 - 20 Victron solar controller
- Maintains and extends battery life & reduces sulphur buildup D.O.D (depth of discharge)
- Reduces 240 volt charging time & associated cost
- Five accreditation certificates
- Individually barcoded for warranty registration
- Panel Dimensions (mm): 1280 x 800 x 35
- Panel Weight (Kg): 11.8

**KIT INCLUDES**

- Premium quality MPPT Solar Controller (IP43 & IP22 Rated)
- 144 cell 160W monocrystalline solar panel
- 2 x EZY mounting rails, 800mm length



*Ideal for large boats & yachts.*



*Trickle-charge your batteries whilst offshore.*

**WARRANTY**

- 10 Year Warranty / 25 year efficiency on solar panel
- 5 year warranty on MPPT solar controller
- 3 Year warranty on complete kit.

**RECOMMENDED APPLICATIONS**



**MANUFACTURING STANDARDS**



PRODUCT CODE  
**KT70721**





**KT SOLAR  
200W, 12V MONOCRYSTALLINE  
PORTABLE SOLAR BLANKET KIT**

The 200W, 12V Portable Solar Blanket is a compact, light-weight solution to your solar needs. Whether camping, caravanning, or four-wheel driving off-road, KT Solar blankets are the perfect solution for maintaining batteries to power portable fridges, camping lights, air-compressors and other 12V equipment.

The solar blanket is suitable for maintenance charging of gel, wet, AGM, calcium & lithium batteries and includes a 20Amp PWM solar charge controller.

- One-piece easy-fold solar blanket with 12 solar cells (4 x horizontal, 3 x vertical)
- Dimensions Folded (mm): 400 x 400 x 135
- Dimensions Unfolded (mm): 1526 x 1140 x 5
- Weight (Kg): 7.53



**WARRANTY**  
2 Year warranty on complete kit.

**RECOMMENDED APPLICATIONS**



**MANUFACTURING STANDARDS**



Power Tolerance	+3%
Maximum Power (Pmax)	200Wp
Maximum Power Voltage (Vmp)	18V
Maximum Power Current (Imp)	11.11A
Rated Voltage	12V
Open Circuit Voltage (Voc)	21V
Short Circuit Current (Isc)	11.54A
Operating Temperature	-40°C to +85°C
Product Application	Class A
Max System Voltage	600V DC

**KT SOLAR  
300W, 12V MONOCRYSTALLINE  
PORTABLE SOLAR BLANKET KIT**

The 300W, 12V Portable Solar Blanket is an industry first innovation by KT Solar, putting out a powerful 300 Watts!

Ideal for off-road adventures, camping & caravanning trips, the 300W solar blanket comes complete with power leads and a 20Amp PWM solar charge controller which is capable of charging gel, wet, AGM, calcium & lithium batteries. Folding down to a convenient briefcase style carry bag, the 300W solar blanket is the ultimate space-saving solar solution to keep your 12V batteries full of charge.

- One-piece easy-fold blanket with 15 solar cells (5 x horizontal, 3 x vertical)
- Dimensions Folded (mm): 390 x 380 x 140
- Dimensions Unfolded (mm): 1526 x 1140 x 5
- Weight (Kg): 8.85



**WARRANTY**  
2 Year warranty on complete kit.

**RECOMMENDED APPLICATIONS**



**MANUFACTURING STANDARDS**



Power Tolerance	+3%
Maximum Power (Pmax)	300Wp
Maximum Power Voltage (Vmp)	18.8V
Maximum Power Current (Imp)	15.95A
Rated Voltage	12V
Open Circuit Voltage (Voc)	22.1V
Short Circuit Current (Isc)	16.42A
Operating Temperature	-40°C to +85°C
Product Application	Class A
Max System Voltage	600V DC



**KT SOLAR**  
**200W, 12V MONOCRYSTALLINE**  
**PORTABLE FOLDING SOLAR BLANKET**

The 200W, 12V Portable Folding Solar Blanket is ideal for camping, 4WD & outdoor applications, perfect for charging 12V batteries that power camping.

- 8 x 25W monocrystalline cells in series
- Flexible charging capabilities (compatible with Lithium, GEL, WET, AGM & Calcium batteries)
- Comes with a 20A, 12V PWM solar charge controller that displays battery voltage, amps, amp hours & error codes
- Comes with a 500mm length 50A extension to positive/negative battery clamp lead & a 4.8m length 50A heavy duty connector lead
- Easy folding for storage convenience
- Dimensions Folded (mm): 355 (L) x 355 (W) x 60 (D)
- Dimensions Unfolded (mm): 740 (L) x 1500 (W) x 7 (D)

Power Tolerance	+3%
Maximum Power (Pmax)	200Wp
Maximum Power Voltage (Vmp)	19.9V
Maximum Power Current (Imp)	10.07A
Rated Voltage	12V
Open Circuit Voltage (Voc)	23.8V
Short Circuit Current (Isc)	10.71A
Operating Temperatures	45 ± 2°C
Product Application	Class A
Max System Voltage	1000V DC
Product Weight	7.5kg



**WARRANTY**  
12 Month warranty on complete kit.

**RECOMMENDED APPLICATIONS**



**MANUFACTURING STANDARDS**



**KT SOLAR**  
**300W, 12V MONOCRYSTALLINE**  
**PORTABLE FOLDING SOLAR BLANKET**

The KT 300W, 12V Portable Folding Solar Blanket is ideal for camping, 4WD & outdoor applications, perfect for charging 12V batteries that power camping fridges, lighting, air-compressors & other 12V devices.

- 12 x 25W monocrystalline cells in series
- Flexible charging capabilities (compatible with Lithium, GEL, WET, AGM & Calcium batteries)
- Comes with a 20A, 12V PWM solar charge controller that displays battery voltage, amps, amp hours & error codes
- Comes with a 500mm length 50A extension to positive/negative battery clamp lead & a 4.8m length 50A heavy duty connector lead
- Easy folding for storage convenience
- Dimensions Folded (mm): 350 (L) x 500 (W) x 70 (D)
- Dimensions Unfolded (mm): 1100 (L) x 1500 (W) x 7 (D)

Power Tolerance	+3%
Maximum Power (Pmax)	300Wp
Maximum Power Voltage (Vmp)	21.7V
Maximum Power Current (Imp)	13.8A
Rated Voltage	12V
Open Circuit Voltage (Voc)	26.5V
Short Circuit Current (Isc)	16.6A
Operating Temperatures	45 ± 2°C
Product Application	Class A
Max System Voltage	1000V DC
Product Weight	11.3kg



**WARRANTY**  
12 Month warranty on complete kit.

**RECOMMENDED APPLICATIONS**



**MANUFACTURING STANDARDS**





**KT SOLAR**  
**120W, 12V PORTABLE**  
**FOLDING SOLAR MAT KIT**

The new and innovative 120W, 12V portable folding solar mat is designed for maintenance charging of 12V batteries.

The 120W solar mat is made up of 6 x 20W solar cells, folding out into a single row. The kit includes power leads with alligator clamps for easy connection to battery and a 10Amp, 12V PWM solar charge controller which displays battery voltage, battery capacity, battery percentage, ambient temperature and load mode. For ultimate solar harvest, the 120W solar mat can be laid flat across a vehicle windscreen, or mounted via the corner eyelets.

- Ideal size for ultimate solar harvest
- 6 x 20W Powerful Monocrystalline Cells
- Unique, compact size for storage convenience
- Folded dimensions (mm): 395 x 360 x 80
- Unfolded dimensions (mm): 2285 x 360 x 5
- Flexible charging capabilities
- Compatible with wet, AGM & calcium batteries
- Ideal for camping, 4wd & outdoor applications
- Perfect for charging 12V batteries that power camping fridges, lighting, air-compressors & other 12V devices
- Includes 10Amp PWM solar charge controller
- Includes 50A heavy duty connector to pos (+) / neg (-) battery clamps, 550mm lead
- Weight (Kg): 5.0
- Unique Neoprene carry pouch



Power Tolerance	+3%
Maximum Power (Pmax)	120Wp
Maximum Power Voltage (Vmp)	19.6V
Maximum Power Current (Imp)	6.12A
Rated Voltage	12V
Open Circuit Voltage (Voc)	23.2V
Short Circuit Current (Isc)	6.67A
Operating Temperature	-40°C to +85°C
Product Application	Class A
Max System Voltage	1000V DC

**WARRANTY**  
12 Month warranty on complete kit.

RECOMMENDED APPLICATIONS



MANUFACTURING STANDARDS



PRODUCT CODE  
**KT70727**



**KT SOLAR**  
**120W, 12V PORTABLE FOLDING SOLAR KIT**

The highly efficient 120W Portable Folding Solar Kit is comprised of 2 x 60W solar cells configured in parallel. The kit includes a 10M extension lead and a 0.5M lead terminated to alligator clamps for simple connection to power. The kit includes a 10Amp, 12V PWM solar charge controller.

- Features
- Powerful 120W, 12V portable 'brief-case' style kit
- Dimensions folded (mm) 710 x 510 x 65
- Dimensions unfolded (mm): 1020 x 710 x 30
- 10 Amp, 12V PWM solar charge controller
- Solar charge controller IP rating: IP65
- Solar controller is compatible with gel, wet, AGM, calcium & lithium batteries
- Controller features reverse polarity, short circuit and over voltage protection
- 10M, 50Amp extension lead
- Positive & negative alligator clamps, 500mm Lead to 50 Amp, 12-48V connector
- Sturdy aluminium leg supports
- Quality stainless steel latches and hinges
- Controller securely mounted to the panel supports, reducing de-rating
- Protective ABS corners
- Heavy duty swivel carry handle
- Heavy duty storage bag
- Weight (Kg): 9.5

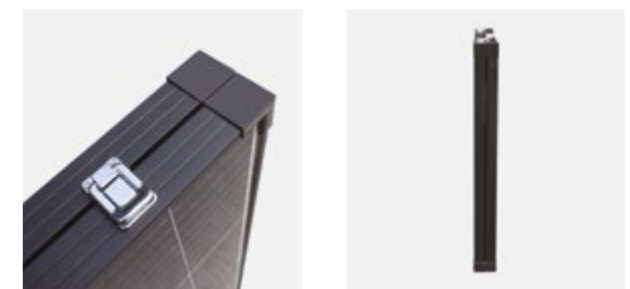

Power Tolerance	+3%
Maximum Power (Pmax)	120Wp
Maximum Power Voltage (Vmp)	17.8V
Maximum Power Current (Imp)	6.74A
Rated Voltage	12V
Open Circuit Voltage (Voc)	21.0V
Short Circuit Current (Isc)	7.74A
Operating Temperature	-40°C to +85°C
Product Application	Class A
Max System Voltage	1000V DC

**WARRANTY**  
12 Month warranty on complete kit.

RECOMMENDED APPLICATIONS



MANUFACTURING STANDARDS



PRODUCT CODE  
**KT70710**



**KT SOLAR  
200W, 12V PORTABLE FOLDING SOLAR KIT  
WITH DUAL CHARGE FEATURE**

The 200W Portable Folding Solar Kit is comprised of 2 x 100W solar cells configured in parallel. The kit includes 2 x 5M extension leads and 2 x 0.5M connector leads to alligator clamps for simple connection to power. The kit includes a 15Amp, 12V Dual Charging PWM solar charge controller - allowing the user to charge two 12V batteries simultaneously.

- Powerful 200W 12V portable 'brief-case' style kit
- Dimensions folded (mm): 787 x 688 x 65
- Dimensions unfolded (mm): 1376 x 688 x 30
- 15 Amp 12V PWM dual solar charge controller for charging two 12V batteries simultaneously
- Solar charge controller IP rating: IP65
- Solar controller is compatible with gel, wet, AGM, calcium & lithium batteries
- Controller features reverse polarity, short circuit and over voltage protection
- 2 x 5M, 50 Amp, 12-48V connector extension leads for simple connection to power
- 2 x 0.5M, 50 Amp, 12-48V connector lead to positive & negative alligator clamps
- Sturdy aluminium leg supports
- Quality stainless steel latches and hinges
- Controller securely mounted to the panel supports, reducing de-rating
- Protective ABS corners
- Heavy duty swivel carry handle
- Heavy duty storage bag
- Weight (Kg): 11.80

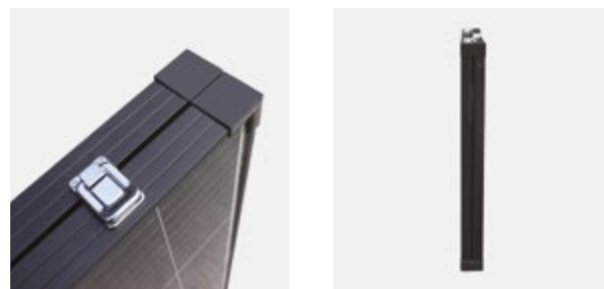

Power Tolerance	+3%
Maximum Power (Pmax)	200Wp
Maximum Power Voltage (Vmp)	19.6V
Maximum Power Current (Imp)	10.20A
Rated Voltage	12V
Open Circuit Voltage (Voc)	23.2V
Short Circuit Current (Isc)	11.27A
Operating Temperature	-40°C to +85°C
Product Application	Class A
Max System Voltage	1000V DC

**WARRANTY**  
12 Month warranty on complete kit.

**RECOMMENDED APPLICATIONS**



**MANUFACTURING STANDARDS**



PRODUCT CODE  
**KT70731**



**KT SOLAR  
UNIVERSAL SOLAR PANEL ROD  
MOUNTING SYSTEM FOR  
5W, 10W & 20W SOLAR PANELS**

Ideal for marine applications, including charging of batteries in boats and jet-skis, rural applications on properties with electric fences, security camera battery charging when 240V AC power is unavailable, 12V garden and outdoor lighting, portable solution to charging isolated batteries anywhere.

- 2 x fully adjustable, sliding locking clamps that will accommodate a 5W, 10W or 20W solar panel easily.
- 5mm allen key included to easily secure panel to mounting system
- The locking swivel knuckle allows the user to adjust the solar panel angle to achieve maximum sun exposure.
- Fishing rod male gimbal butt which locks into most universal female rod holders
- 12V, 5 Amp PWM solar charge controller included.

PRODUCT CODE  
**KT70753**

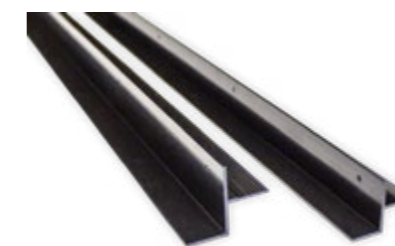

**KT SOLAR  
TWIN SOLAR PANEL  
MOUNTING 'EZY' RAILS**

Robust anodised black aluminium extrusion.

- Can be cut to required length.
- Multiple pre-drilled mounting holes.
- Includes mounting hardware

**LARGE**

Suited to solar panels with a side profile of up to 35mm.

- Dimensions (mm): 800 (L) x 50 (W) x 42 (H).

PRODUCT CODE  
**KT70747**

**SMALL**

Suited to solar panels with a side profile of 17-25mm.

- Dimensions (mm): 800 (L) x 40 (W) x 32 (H).

PRODUCT CODE  
**KT70748**



**KT SOLAR  
SOLAR PANEL MOUNTING BRACKETS  
4 PACK WITH 8MM T-BOLT HOLE**

Anodised for enhanced weather and corrosion resistance. Stylish, modern design, suits 5W-150W panels.

- Dimensions (mm): 101 (L) 66 (W) x 43 (H).
- 8mm T-Bolt Hole for easy mounting to roof-racks.
- Wind speed capacity is approximately: 50m/s.
- Snow load capacity 3KN/m2.

PRODUCT CODE  
**KT70749**



**KT SOLAR  
8 AMP, 12V PWM  
SOLAR CHARGE CONTROLLER**

The KT 8 Amp Solar Charge Controller is designed to regulate the amount of charge coming from the panel that flows into the deep cycle battery in order to avoid batteries being overcharged.

- Maintenance charger for small sealed lead-acid batteries
- Compatible with battery types: gel, wet, AGM, calcium
- Suitable for use with 12V solar panels up to 135W
- Advanced pulse width modulation technology (PWM)
- Adjustable dip switch for pre-setting battery chemistry
- LED indicators denote charging full / or fault
- Potted for 100% no condensation
- IP65 rated – dustproof and splashproof
- Easy three point mounting.

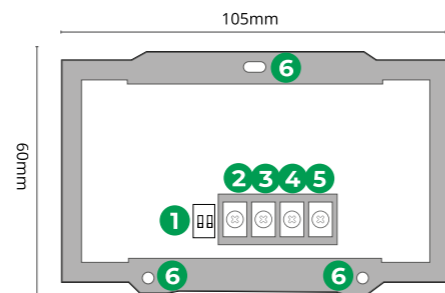

1. Dip Switches
2. Battery (-)
3. Battery (+)
4. Solar Cell (-)
5. Solar Cell (+)
6. Mount Points

Operating Temperature	-20°C to +80°C
Operating Voltage	12V
Rated to (Amps)	8A
Rated to (Voltage)	12V
Battery Voltage	12V
Dimensions (mm)	60 (H) x 105 (W) x 35 (D)
Product Weight (Kg)	1.20
Manufactured from material	Polycarbonate



MANUFACTURING STANDARDS



PRODUCT CODE  
KT70755

**KT SOLAR  
10 AMP, 12V PWM  
SOLAR CHARGE CONTROLLER**

The KT 10 Amp Solar Charge Controller is designed to regulate the amount of charge coming from the panel that flows into the deep cycle battery in order to avoid batteries being overcharged.

- Maintenance charger for small sealed lead-acid batteries
- Compatible with battery types: Gel, Wet, AGM, Calcium & Lithium
- Suitable for use with 12V solar panels up to 150W
- Advanced pulse width modulation technology (PWM)
- LCD information screen with selection modes for battery chemistry
- LED indicators display battery status
- Potted for 100% no condensation
- IP65 rated – dustproof and splashproof
- Easy two point mounting.

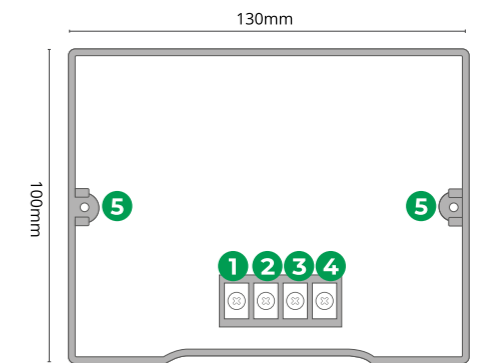

1. Dip Switches
2. Battery (-)
3. Battery (+)
4. Solar Cell (-)
5. Solar Cell (+)
6. Mount Points

Operating Temperature	-20°C to +80°C
Operating Voltage	12V
Rated to (Amps)	10A
Rated to (Voltage)	12V
Battery Voltage	12V
Dimensions (mm)	100 (H) x 130 (W) x 28 (D)
Product Weight (Kg)	1.20
Manufactured from material	Polycarbonate



MANUFACTURING STANDARDS



PRODUCT CODE  
KT70756

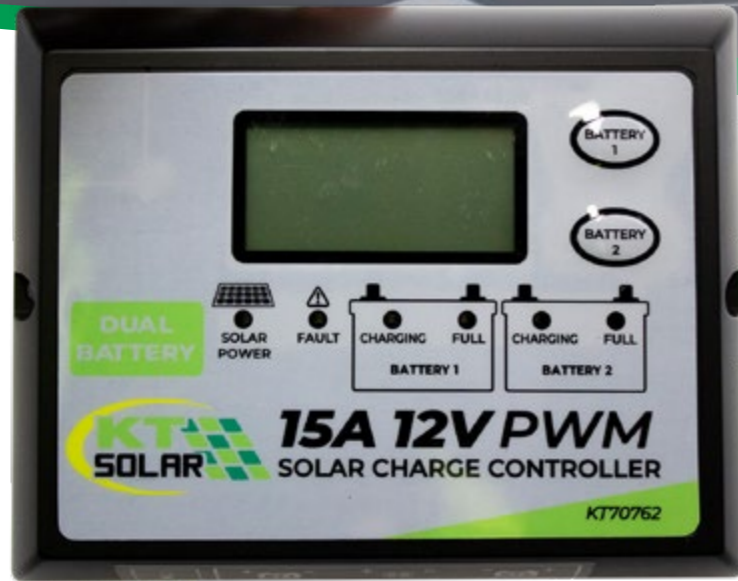

**KT SOLAR  
15 AMP, 12V PWM  
DUAL SOLAR CHARGE CONTROLLER**

The KT 15 Amp Dual Solar Controller is designed to charge 2 x 12V Batteries simultaneously. Suited to charge gel, wet, AGM, calcium and lithium battery types, this charge controller prevents batteries from becoming overcharged. The unit provides an automatic equalisation feature for deeply drained conventional lead-acid or calcium batteries.

- Ideal for charging 2 x lead-acid batteries simultaneously
- Compatible with battery types: gel, wet, AGM, calcium and lithium
- Solar panel max. 200W or 2 x 120W solar panels
- Selection modes for battery 1 and battery 2
- Preset percentage of available charge
- Reverse polarity, short circuit & over voltage protection
- Pulse width modulation technology (PWM)
- LCD Information screen with selection modes for battery chemistry
- LED indicators display battery status
- Potted for 100% no condensation
- IP65 rated – dustproof and splashproof
- Easy two point mounting.

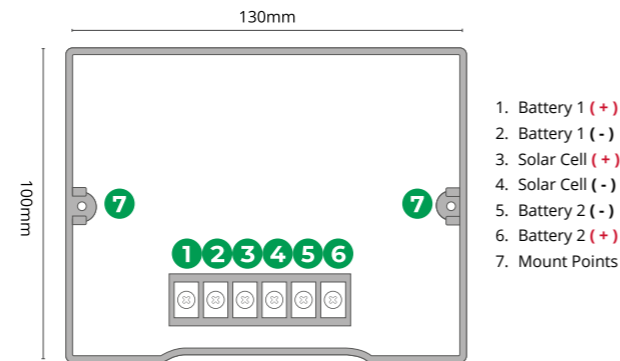

Operating Temperature	-20°C to +80°C
Operating Voltage	12V
Rated to (Amps)	15A
Rated to (Voltage)	12V
Battery Voltage	12V
Dimensions (mm)	100 (H) x 130 (W) x 28 (D)
Product Weight (Kg)	1.20
Manufactured from material	Polycarbonate



PRODUCT CODE  
**KT70762**

**KT SOLAR  
20 AMP, 12V PWM  
SOLAR CHARGE CONTROLLER**

The KT 20 Amp Solar Charge Controller is designed to regulate the amount of charge coming from the panel that flows into the deep cycle battery in order to avoid batteries being overcharged.

- Maintenance charger for lead-acid batteries
- Compatible with battery types: gel, wet, AGM, calcium & lithium
- Suitable for use with 12V solar panels up to 200W or 2 x 150W panels configured in parallel
- Advanced pulse width modulation technology (PWM)
- LCD Information screen with selection modes for battery chemistry
- LED indicators display battery status
- Potted for 100% no condensation
- IP65 rated – dustproof and splashproof
- Easy two point mounting.

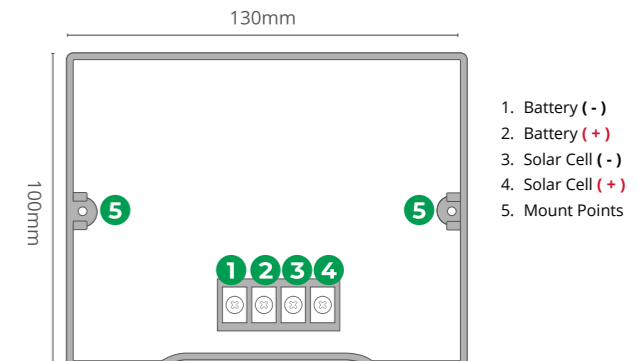

Operating Temperature	-20°C to +80°C
Operating Voltage	12V
Rated to (Amps)	20A
Rated to (Voltage)	12V
Battery Voltage	12V
Dimensions (mm)	100 (H) x 130 (W) x 28 (D)
Product Weight (Kg)	1.20
Manufactured from material	Polycarbonate



PRODUCT CODE  
**KT70757**

SOLAR PANELS & CONTROLLERS

344

SOLAR PANELS & CONTROLLERS

345



**KT SOLAR  
5AMP 12V-24V SOLAR CHARGE  
CONTROLLER**

The KT 5 Amp 12V-24V Solar Charge Controller is a safe and efficient way to regulate solar power for Monocrystalline Solar Panels from 10W up to 40W. This solar charge controller offers a 12 Month Warranty.

- Efficient solar power regulation
- Suits fixed & portable solar panels from 10W up to 40W
- Suits GEL, WET, AGM, CALCIUM, LTO, LIFEPO4 & LI-ION battery chemistry types
- 6 Charging Stages including Trickle, Boost, Absorb, Float, Full & Maintain Float
- 6 Safety Protection Features including Overcharge, Reverse Polarity, Short Circuit, Working Battery, Temperature, & Reverse Charging
- PWM (Pulse-Width Modulation) Technology

PRODUCT CODE  
**KT70780**



**KT SOLAR  
10AMP 12V-24V SOLAR CHARGE  
CONTROLLER**

The KT 10 Amp 12V-24V Solar Charge Controller is a safe and efficient way to regulate solar power for Monocrystalline Solar Panels from 20W up to 170W. This solar charge controller offers a 12 Month Warranty.

- Efficient solar power regulation
- Suits fixed & portable solar panels from 20W up to 170W
- Suits GEL, WET, AGM, CALCIUM, LTO, LIFEPO4 & LI-ION battery chemistry types
- 6 Charging Stages including Trickle, Boost, Absorb, Float, Full & Maintain Float
- 6 Safety Protection Features including Overcharge, Reverse Polarity, Short Circuit, Working Battery, Temperature, & Reverse Charging
- PWM (Pulse-Width Modulation) Technology

PRODUCT CODE  
**KT70781**



**KT SOLAR  
20AMP 12V-24V SOLAR CHARGE  
CONTROLLER**

The KT 20 Amp 12V-24V Solar Charge Controller is a safe and efficient way to regulate solar power for Monocrystalline Solar Panels from 100W up to 300W. This solar charge controller offers a 12 Month Warranty.

- Efficient solar power regulation
- Suits fixed & portable solar panels from 100W up to 300W
- Suits GEL, WET, AGM, CALCIUM, LTO, LIFEPO4 & LI-ION battery chemistry types
- 6 Charging Stages including Trickle, Boost, Absorb, Float, Full & Maintain Float
- 6 Safety Protection Features including Overcharge, Reverse Polarity, Short Circuit, Working Battery, Temperature, & Reverse Charging
- PWM (Pulse-Width Modulation) Technology

PRODUCT CODE  
**KT70783**



**KT SOLAR  
50A, 12V HEAVY DUTY CONNECTOR  
WITH IN-BUILT VOLTMETER**

Designed and developed by KT, this connector is unlike standard heavy duty connectors on the market. The device is simple to operate and doubles as a 50Amp Heavy Duty Connector and Voltmeter, providing a live voltage reading of your power connection at the touch of a button. The connector is molded from ultra durable polycarbonate and features a waterproof (IP67) LCD, making it suited to standard, heavy duty and marine environments.

- Live voltage reading via smart-touch LCD
- Reading appears with touch & turns off automatically after 30 seconds
- Waterproof LCD
- Voltage: 12V DC at 50 Amps
- Suits cable size: 8B&S (8mm<sup>2</sup>)
- Nickel plated copper pins
- Pack includes one 50A heavy duty voltmeter connector.

RECOMMENDED APPLICATIONS



**12 MONTH WARRANTY**

PRODUCT CODE  
**KT70030S**



**Notes:** Additional Standard 50Amp heavy duty connector pictured for illustrative purposes only.



**KT SOLAR SOLAR PANEL Y-LEAD CONNECTOR 2 SOCKETS TO 1 PLUG**

Used for connecting the output of two solar panels into a parallel circuit, or multiple panels in an array.

- Waterproof and UV resistant.
- IP 67 Rated.
- Tin plated copper contacts.
- TUV certified.
- 300mm in length.
- Operating temperature -40°C to +90°C.

PRODUCT CODE  
**KT70770**



**KT SOLAR SOLAR MC4 Y-LEAD CONNECTOR 2 PLUGS TO 1 SOCKET**

Used for connecting the output of two solar panels into a parallel circuit, or multiple panels in an array.

- Waterproof and UV resistant.
- IP 67 Rated.
- Tin plated copper contacts.
- TUV certified.
- 300mm in length.
- Operating temperature -40°C to +90°C.

PRODUCT CODE  
**KT70771**



**KT SOLAR Y-LEAD SOLAR CONNECTORS TWIN PACK**

Designed to connect the output of two solar panels into a parallel circuit or multiple panels in array.

- 1 x 2 female-1 male connector Y-lead (KT70770)
- 1 x 2 male-1 female connector Y-lead (KT70771)
- 300mm lead lengths

PRODUCT CODE  
**KT70776**



**KT SOLAR SOLAR MC4 CONNECTOR FEMALE**

For solar cable connections.

- Tin plated copper contacts.
- TUV certified.
- Operating temperature -40°C to +90°C.

PRODUCT CODE  
**KT70773**



**KT SOLAR SOLAR MC4 CONNECTOR MALE**

For solar cable connections.

- Tin plated copper contacts.
- TUV certified.
- Operating temperature -40°C to +90°C.

PRODUCT CODE  
**KT70772**



**KT SOLAR SOLAR MC4 CONNECTOR MALE & FEMALE TWIN PACK**

Female & male connections.

- Tin plated copper contacts.
- Operating temperature: -40°C to 90°C.

PRODUCT CODE  
**KT70774**



**KT SOLAR 50 AMP, 12-48V CONNECTOR TO MALE & FEMALE SOLAR CONNECTORS**

Ideal for automotive, marine, solar & outdoor applications.

- Heavy duty connector rating: 50A, 12V-48V
- Solar connectors rated to 2.20A, 12-48V (TUV certified)
- Solar connector contacts: tin plated copper
- Heavy duty connector housing: polycarbonate
- Cable protection: UV treated, flame-retardant corrugated loom with heavy duty nylon gland end pieces
- Cable length: 600mm
- Cable type: 6mm<sup>2</sup>.

PRODUCT CODE  
**KT70566**



**KT SOLAR 5M EXTENSION LEAD, 50 AMP, 12-48V CONNECTOR TO MALE & FEMALE SOLAR CONNECTORS**

Ideal for automotive, marine, solar & outdoor applications.

- Heavy duty connector rating: 50A, 12V-48V
- Solar connectors rated to 12-48V (TUV certified)
- Solar connector contacts: tin plated copper
- Heavy duty connector housing: polycarbonate
- Cable protection: UV treated, flame-retardant corrugated loom with heavy duty nylon gland end pieces
- Cable length: 5M
- Cable type: 6mm<sup>2</sup> twin core automotive cable (8AWG).

PRODUCT CODE  
**KT70567**



**KT SOLAR SOLAR CHARGE CONTROLLER POWER LEAD**

50A 12V-48V heavy duty connector to 6mm yellow fork terminals for direct power connection 'to and from' solar charge controller.

- Designed for use with KT PWM Solar Charge Controllers 5A, 10A, 20A and 15A+15A Dual Battery.

PRODUCT CODE  
**KT70574**



**KT SOLAR 50A, 12V-48V HEAVY DUTY CONNECTOR**

Blue, single pack.

- Amp rating: 50A
- Voltage rating: 12-48V
- Suits 8B&S cable (8mm)
- Includes silver plated copper terminals
- Manufactured from impact-resistant polycarbonate
- Connects with blue 50A heavy duty connectors.

PRODUCT CODE  
**KTHDC50BE**



**KT SOLAR 600MM SOLAR LEAD, MALE & FEMALE SOLAR CONNECTORS TO 8MM RING TERMINALS**

Ideal for automotive, marine, solar & outdoor applications.

- Solar connectors rated to 12-48V (TUV certified)
- Solar connector contacts: tin plated copper
- 2 x 8mm ring terminals for easy connection to battery
- Cable protection: UV treated, flame-retardant corrugated loom with heavy duty nylon gland end pieces
- Cable length: 600mm
- Cable type: 6mm<sup>2</sup>.

PRODUCT CODE  
**KT70568**



**KT SOLAR 50AMP HEAVY DUTY CONNECTOR TO FORK TERMINALS**

Provides power connection 'to and from' solar charge controller. Ideal for automotive, marine, solar and outdoor applications. Suitable for use with all KT solar charge controllers.

- Connector Rating: 50A, 12V-48V
- Connector Housing: Polycarbonate
- Terminals: Silver plated copper
- Fuse: 20A In-line

PRODUCT CODE  
**KT70573**



**KT SOLAR 50A, 12V-48V HEAVY DUTY CONNECTOR**

Red, single pack.

- Amp rating: 50A
- Voltage rating: 12-48V
- Suits 8B&S cable (8mm)
- Includes silver plated copper terminals
- Manufactured from impact-resistant polycarbonate
- Connects with blue 50A heavy duty connectors.

PRODUCT CODE  
**KTHDC50RD**





## MARINE

Light Bars .....	352
Work Lamp Bars.....	353
Scene Lamp .....	353
Deck Lamps .....	354
Work Lamps.....	354
Strip Lamp.....	354
LED Tape .....	355
Search Lamps .....	356
Spot Lights .....	357
Interior Lighting.....	358
Underwater Lights .....	358
Navigation Lights .....	359
Mast Lamps / Anchor Lamps.....	360
Trailer Safety / Trailer Lighting .....	361
USB Sockets .....	362
Low Voltage Sockets .....	362
Marine & Battery Switches.....	363
Ignition Switches .....	364
Relays .....	364
Switch Panels.....	365
LED Rocker Switches.....	366
LED USB Socket .....	366
Electrical Marine Cable.....	368
Stainless Steel Cable Ties .....	369
Fuse Boxes.....	369
Headunits.....	370
Subwoofer .....	370
Speaker Systems .....	370
Speakers & Enclosures .....	371
Amplifiers.....	372

# NAVIGATA



**NARVA  
MARINE LIGHT BARS**

The all new range of Navigata L.E.D light bars feature advanced Optic Drive™ technology, which captures and focuses more of the light generated to produce an extra penetrating light output, eliminating waste and resulting in a 30% brighter output.

- One piece die-cast aluminium housing designed without end caps provides optimum sealing and heat dissipation.
- Virtually unbreakable hard coated polycarbonate lens.
- Stainless steel brackets & mounting hardware (SUS316).
- Fully sealed and submersible (IP68 & IP69K approved).
- Integrated genuine Nitto Breather Vent.
- Pre-wired weatherproof DT connector.



**180MM 9-32V**

- Current Draw: 1.6A at 12V, 0.9A at 24V

PRODUCT CODE  
**72271W**



**350MM 9-32V**

- Current Draw: 2.6A at 12V, 1.3A at 24V

PRODUCT CODE  
**72272W**



**550MM 9-32V**

- Current Draw: 3.7A at 12V, 1.9A at 24V

PRODUCT CODE  
**72274W**



**550MM 9-32V**

- Current Draw: 6.6A at 12V, 3.0A at 24V

PRODUCT CODE  
**72282W**

**NARVA®**  
THE VISION TO GO FURTHER



**NARVA  
HEAVY-DUTY LED FLOOD BEAM  
MARINE WORK LAMP BAR  
1600 LUMENS**

Extreme performance and reliability with a heavy-duty slimline die-cast and powder coated aluminium housing ideal for RV and 4WD applications. Fully sealed (IP68) and pre-wired. With white powder coated finish and marine grade 316 stainless steel mounting hardware.

- 8 x 3W high power L.E.Ds.
- Virtually unbreakable polycarbonate lens.
- 250mm pre-wired lead with Deutsch® connector.
- Current Draw: 1.2A at 12V, 0.6A at 24V

PRODUCT CODE  
**72733W**



**NARVA  
HEAVY-DUTY LED FLOOD BEAM  
MARINE WORK LAMP BAR  
2400 LUMENS**

Extreme performance and reliability with a heavy-duty slimline die-cast and powder coated aluminium housing ideal for RV and 4WD applications. Fully sealed (IP68) and pre-wired with white powder coated finish and marine grade 316 stainless steel mounting hardware

- 12 x 3W high power L.E.Ds.
- Virtually unbreakable polycarbonate lens.
- 250mm pre-wired lead with Deutsch® connector.
- Current Draw: 1.8A at 12V, 0.9A at 24V

PRODUCT CODE  
**72736W**



**NARVA  
HEAVY-DUTY LED FLOOD BEAM  
MARINE WORK LAMP BAR  
800 LUMENS**

Extreme performance and reliability with a heavy-duty slimline die-cast and powder coated aluminium housing ideal for RV and 4WD applications. Fully sealed (IP68) and pre-wired. With white powder coated finish and marine grade 316 stainless steel mounting hardware.

- 5 x 3 watt high powered L.E.Ds.
- Virtually unbreakable polycarbonate lens.
- 250mm pre-wired lead with Deutsch® connector.
- Current Draw: 0.6A at 12V, 0.3A at 24V

PRODUCT CODE  
**72730W**



**NARVA  
9-33V LED FLOOD BEAM  
WHITE SCENE LAMP  
2700 LUMENS**

Engineered for emergency services vehicles and also suitable for marine applications where high levels of ingress protection are required (IP68 and IP69 ingress protection). Constructed from a die-cast aluminium housing and ASA covers for the best possible UV protection.

- Virtually unbreakable polycarbonate lens with hard coating.
- Complies to ECE R10 and CISPR 25 EMC standards.
- Snap on end caps to conceal mounting screws.
- Current Draw: 1.1A at 12V, 0.6A at 24V.

PRODUCT CODE  
**72467W**



**NARVA LED DECK LAMP RED/WHITE LIGHT OUTPUT**

Corrosion and galvanic corrosion on aluminium boats needs to be managed. By using a nylon bracket and nylon fixing hardware, including a nylon locknut and washer to fix the lamp to the boat, galvanic corrosion between the bracket and aluminium is no longer possible.

- White/red illumination is ideal for night vision.
- Features a plastic lamp body and bracket to prevent corrosion of the lamp, bracket, and galvanic corrosion on aluminium boats.
- 1000 Lumen white output (5700°K) and 623nm red output.
- Ideal for marine environments (IP67).
- Shock and vibration tested to JIS D1601 (marine standard).

PRODUCT CODE  
**72443 BLACK**  
**72443/10 BLACK – PACK OF 10**  
**72443W WHITE**  
**72443W/10 WHITE – PACK OF 10**



**NARVA 12V DUAL COLOUR STRIP LAMP**

These sleek and low profile strip lamps feature dual colour SMD technology enabling one lamp to do the job of two. They are fully sealed to IP66 and suitable for either interior or exterior fitment. Surface mount design for easy installation.

- Ideal for fitment to both RV and Marine applications as the blue illumination provides comfortable mood lighting and a premium feel.
- Suitable for exterior or interior applications.
- Slim design - 13mm.
- Ultra reliable, fully sealed (IP66) and sea/salt spray resistant.

PRODUCT CODE  
**87538WBBL WHITE/BLUE L.E.D**  
**87538WRBL WHITE/RED L.E.D**



**NARVA 9-33V LED 600 LUMENS MARINE WORK LAMP**

The benefits of L.E.D technology are numerous so it's no surprise that work lamps are utilising L.E.Ds to provide lamps with lower current draw and long life. Perhaps more importantly L.E.Ds are resistant to shock and vibration making L.E.D work lamps tougher than their halogen counterparts.

- Powerful 4 x 1W slim and compact L.E.D work lamp.
- Fully sealed (IP66) with a pre-wired, die-cast powder coated aluminium housing.
- Virtually unbreakable stainless polycarbonate lens.
- Marine grade 316 stainless steel mounting hardware.

PRODUCT CODE  
**72412W**



**NARVA 9-64V LED FLOOD BEAM WHITE WORK LAMP 1800 LUMENS**

Four ultra reliable 5W L.E.Ds deliver a powerful spread of whiter and brighter light. Fully sealed (IP66) with a pre-wired die-cast white powder coated aluminium housing with marine grade 316 stainless steel mounting hardware.

- Virtually unbreakable polycarbonate lens.
- Includes stainless steel mounting hardware and 0.5m of pre-wired cable.
- Current Draw: 1.3A at 12V, 0.7A at 24V.

PRODUCT CODE  
**72449W**



**NARVA HEAVY-DUTY LED MARINE WORK LAMP BAR 800 LUMENS**

Features a powerful yet compact work lamp with two powerful 5W L.E.Ds ideal for close range illumination and where space is limited. Fully sealed (IP66) with a pre-wired die-cast powder coated aluminium housing, white powder coated finish with marine grade 316 stainless steel mounting hardware.

- Virtually unbreakable polycarbonate lens.
- Includes stainless steel mounting hardware.
- Current Draw: 0.58A at 12V, 0.3A at 24V.

PRODUCT CODE  
**72446W**



**NARVA 9-64V LED FLOOD BEAM WHITE WORK LAMP 2700 LUMENS**

Six 5W L.E.Ds combine to deliver an intense and broad spread of bright white light. Fully sealed (IP66) with a pre-wired die-cast white powder coated aluminium housing with marine grade 316 stainless steel mounting hardware

- Virtually unbreakable polycarbonate lens.
- Includes stainless steel mounting hardware and 0.5m of pre-wired cable.
- Current Draw: 1.85A at 12V, 0.9A at 24V.

PRODUCT CODE  
**72451W**



**NARVA 12V AMBIENT COOL LED TAPE**

Flexible L.E.D tape provides a soft, cool white ambient light ideal for background illumination. Ideal for boat footwells, caravan cabinets, under benches etc. Self adhesive with strong 3M™ backing tape.

- Flexible L.E.D tape provides a soft, cool white ambient light ideal for background illumination
- Ideal for boat footwells, caravan cabinets, under benches etc.
- Self adhesive with strong 3M™ backing tape

PRODUCT CODE  
**87800BL 30CM – BLISTER PACK**  
**87801/10 60CM – BULK PACK OF 10**  
**87801BL 60CM – BLISTER PACK**  
**87802/10 1.2M – BULK PACK OF 10**  
**87802BL 1.2M – BLISTER PACK**  
**87804 5M REEL**

**NARVA 12V HIGH COOL WATERPROOF LED TAPE 5 METRES**

Flexible L.E.D strip provides superior light output ideal for illuminating large areas around your caravan, camper trailer etc. Waterproof (IP68) ideal for interior, exterior and marine applications. Waterproof and flexible structure allows for permanent installation.

- Flexible L.E.D strip provides superior light output ideal for illuminating large areas around your caravan, camper trailer etc.
- Waterproof (IP68) ideal for interior, exterior and marine application
- Waterproof and flexible structure allows for permanent installation.
- 5m reel

PRODUCT CODE  
**87810**  
**87810B BLUE**  
**87810R RED**



**NARVA 12V AMBIENT WARM LED TAPE**

Flexible L.E.D tape provides a soft, warm ambient light ideal for background illumination. Ideal for boat footwells, caravan cabinets, under benches etc. Self adhesive with strong 3M™ backing tape.

- Flexible L.E.D tape provides a soft, cool white ambient light ideal for background illumination
- Ideal for boat footwells, caravan cabinets, under benches etc.
- Self adhesive with strong 3M™ backing tape

PRODUCT CODE  
**87800WBL 30CM – BLISTER PACK**  
**87801WBL 60CM – BLISTER PACK**  
**87802WBL 1.2M – BLISTER PACK**  
**87804W 5M REEL**



**NARVA 12V HIGH COOL LED TAPE**

Flexible L.E.D tape provides superior light output ideal for both interior and exterior fitment around your vehicle, caravan, camper trailer, boat etc. Self adhesive with strong 3M™ backing tape.

- Flexible L.E.D tape provides a soft, cool white ambient light ideal for background illumination
- Ideal for boat footwells, caravan cabinets, under benches etc.
- Self adhesive with strong 3M™ backing tape

PRODUCT CODE  
**87805BL 30CM – BLISTER PACK**  
**87806/10 60CM – BULK PACK OF 10**  
**87806BL 60CM – BLISTER PACK**  
**87807BL 1.2M – BLISTER PACK**  
**87809 5M REEL**





**NARVA  
12V  
3000 LUMEN  
REMOTE CONTROL  
SEARCH LAMP**

A compact, powerful 30W L.E.D search lamp that is ideal for applications where space is limited and reliability is essential. Can be permanently mounted with its flange base or utilise the inbuilt ceramic disc magnet for temporary installation. Supplied with a convenient weatherproof wireless remote control.

- 6 x 5W high powered L.E.Ds (6000K).
- 360 degree rotation & 90 degree tilt.
- Emergency flash mode.
- Waterproof wireless remote control (65m range).
- Weatherproof and UV resistant housing.
- Fully sealed (IP68) L.E.D module.
- Includes magnetic mounting option and 4m lead.
- Wireless Remote Distance: 65 metres.

PRODUCT CODE  
**72802 BLACK**  
**72803 WHITE**



**NARVA  
12V  
5000 LUMEN  
REMOTE CONTROL  
BLACK SEARCH LAMP**

Featuring dual speed control allowing a fast beam adjustment to sweep an area or a slow speed for more precise search & beam focus. This powerful 50W lamp utilises advanced optics to capture and project the light in a strong penetrating beam.

- 10 x 5W high powered L.E.Ds (6000K).
- 360 degree rotation & 120 degree tilt.
- Dual speed (slow/rapid)
- Waterproof wireless remote control (65m range).
- Weatherproof and UV resistant housing.
- Fully sealed (IP68) L.E.D module.

PRODUCT CODE  
**72806 12V BLACK**  
**72808 12V WHITE**  
**72809 24V WHITE**



**NARVA  
SEARCH LAMP WIRED  
REMOTE JOYSTICK**

To suit L.E.D Remote Control Search Lamps 72808, 72809

PRODUCT CODE  
**74139**



**NARVA  
SEARCH LAMP  
WIRELESS REMOTE**

To suit L.E.D Remote Control Search Lamps 72802, 72806, 72808, 72809

PRODUCT CODE  
**74138**



**NARVA  
SEARCH LAMP 10M EXTENSION LEAD**

To suit L.E.D Remote Control Search Lamps 72808 & 72809.

PRODUCT CODE  
**74140**



**NARVA  
HANDHELD COLT  
1000 LED SPOT LIGHT  
4000 LUMEN**

This heavy duty LED handheld spotlight features 6 high powered LEDs, providing a crisp spot beam range of up to 285 metres. Specifically designed and tested for tough conditions, the 'Colt 1000' has a tough lightweight build, without compromising the L.E.Ds performance output.

- 6 x 5W L.E.Ds producing 4000 raw lumens.
- 285 metre beam pattern at 1 Lux.
- Crisp 5700°K light output.
- Durable construction with ergonomic handle.
- Includes 12/24V accessory plug.

PRODUCT CODE  
**71001**

**NARVA  
BATTERY TO SUIT 71000**

Replacement battery for 'Colt 1000' Spot Light.

PRODUCT CODE  
**71007**



**NARVA  
HANDHELD COLT  
1000 LED SPOT LIGHT  
2700 LUMEN**

This heavy duty, rechargeable LED handheld spotlight features 6 high powered LEDs which produces an impressive spot beam with up to 244m beam distance. The 'Colt 1000' is protected by a heavy-duty casing making it fully sealed and waterproof.

- 6 x 3W L.E.Ds producing 2700 raw lumens.
- 244 metre beam pattern at 1 lux.
- Crisp 5700K light output.
- Rechargeable, removable 7.4V Lithium battery.
- Durable construction with ergonomic handle.
- 2.5 hours use with 1.5 hour recharge.
- Fully sealed and waterproof (IP66).
- Includes 240V AC Charger.

PRODUCT CODE  
**71000**

**NARVA  
240V CHARGER TO SUIT 71000**

240V Charger for 'Colt 1000' Spot Light.

PRODUCT CODE  
**71009**

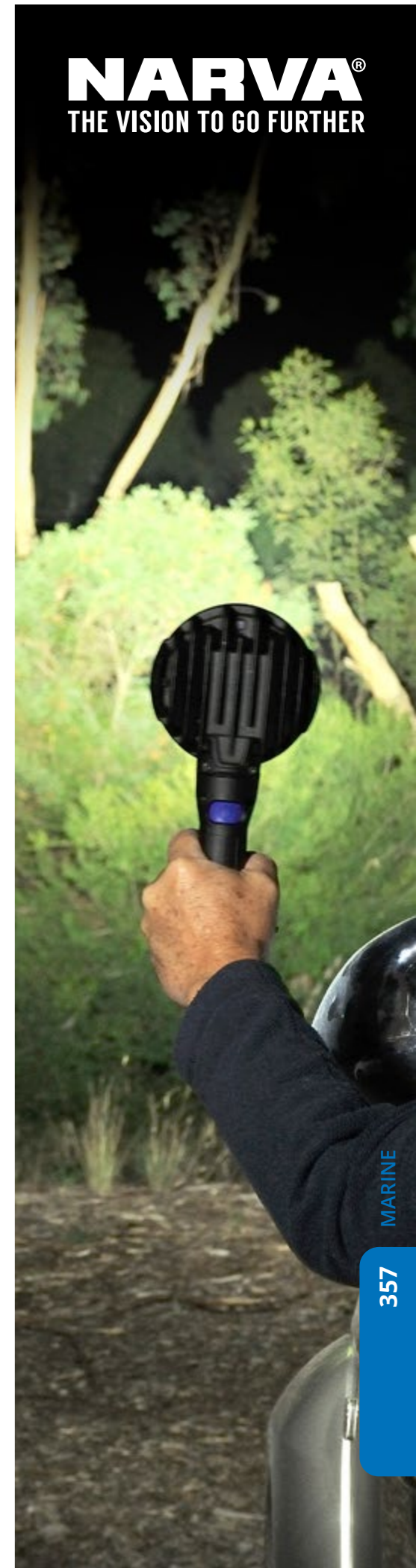

**NARVA®**  
THE VISION TO GO FURTHER



**NARVA**  
12V 75MM RED/WHITE  
INTERIOR LAMP

This interior lamp is ideal for applications where night vision needs to be preserved like marine and truck cabin interiors. The dual colour function allows white or red illumination.

- Dual colour white and red L.E.Ds.
- Red illumination for easy night time navigation.
- Suitable for exterior and interior applications.
- Slim design.
- Ultra reliable with 50,000 hours life.
- IP66 - Fully sealed and sea/salt spray resistant.

PRODUCT CODE  
**87501WR-BKBL** 75MM - BLACK HOUSING  
**87501WRBL** 75MM - WHITE HOUSING  
**87503WR-BKBL** 150MM - BLACK HOUSING  
**87503WRBL** 150MM - WHITE HOUSING



**NARVA**  
12/24V LED DOCK LIGHT WHITE

Mounted above the water this powerful dock lamp illuminates the area in front of the vessel to assist with visibility when mooring a vessel.

- 3 x 1W White L.E.Ds provide a smooth spread of light.
- Surface mount.
- Ultra reliable with over 50,000 hours life.
- IP68 - fully sealed and reliable.
- 600mm of cable.

PRODUCT CODE  
**99200BL**



**NARVA**  
12/24V COOL WHITE  
CHROME STEP LIGHT

Designed for use in caravan, RV and marine applications, this L.E.D step light provides excellent illumination. A stylish and economical option for lighting steps and other small spaces.

- Increased step safety.
- Easy to install.
- Suitable for interior or exterior applications.
- Ultra reliable with 50,000 hours life.
- IP67 - Fully sealed and sea/salt spray resistant.

PRODUCT CODE  
**87608BL** COOL WHITE  
**87609BL** BLUE  
**87610BL** RED



**NARVA**  
12/24V LED UNDERWATER LIGHT

This powerful underwater lamp uses blue L.E.Ds to illuminate the area around the vessel to dramatically increase the visibility of marine life and other objects around the vessel.

- 3 x 5W L.E.Ds for optimal underwater visibility.
- Specially designed heatsink allows increased output.
- Surface mount.
- Ultra reliable with over 50,000 hours life.
- IP68 - fully sealed and reliable.

PRODUCT CODE  
**99202BL** BLUE  
**99204BL** WHITE



**NARVA**  
12V HAND RAIL LIGHT

Designed for use in caravans, recreational vehicles and boats, this premium hand rail light provides effective illumination matched with sophisticated styling.

- A smooth cool light provides increased safety and step illumination.
- Fully sealed to IP67, it is ideal for interior or exterior applications and is sea/salt spray resistant.

PRODUCT CODE  
**87605**



**NARVA**  
9-33V  
2NM LED STERN LAMP

This stern light allows yachts and powerboats up to 50 metres to operate safely at night.

- Minimum visible distance of 2 nautical miles at 135 degrees.
- Meets EMC EN60945, USCG & ABYC A-16 Standards.
- Surface mount.
- Ultra reliable with over 50,000 hours life.
- IP67 - fully sealed and sea/salt spray resistant.

PRODUCT CODE  
**99120BL** WHITE  
**99122BL** BLACK



**NARVA**  
9-33V  
2 NM LED BI-COLOUR LAMP  
WHITE HOUSING  
WITH RED/GREEN LENSES

Ideal for yachts and powerboats up to 20 metres this bi-colour lamp combines style and functionality to ensure any vessel can operate at night.

- Minimum visible distance of 1 nautical mile at 112.5 degrees.
- Meets EMC EN60945, USCG & ABYC A-16 Standards.
- Surface mount, ideal for mounting on the top of the bow.
- Ultra reliable with over 50,000 hours life.
- IP67 - fully sealed and sea/salt spray resistant.

PRODUCT CODE  
**99080BL**



**NARVA**  
9-33V  
1NM LED PORT & STARBOARD LAMPS

Ideal for yachts and powerboats up to 12 metres these Port and Starboard lamps combine style and functionality to ensure any vessel can operate at night.

- Minimum visible distance of 1 nautical mile at 112.5 degrees.
- Meets EMC EN60945, USCG & ABYC A-16 Standards.
- Surface mount, ideal for mounting on the side of the hull.
- Ultra reliable with over 50,000 hours life.
- IP67 - fully sealed and sea/salt spray resistant.

PRODUCT CODE  
**99010BL** WHITE WITH COLOURED LENSES  
**99012BL** WHITE WITH CLEAR LENSES  
**99014BL** BLACK WITH COLOURED LENSES  
**99016BL** BLACK WITH CLEAR LENSES



**NARVA**  
9-33V  
1 NM BLACK HOUSING LED  
PORT & STARBOARD LAMPS  
WITH COLOUR LENSES

Ideal for yachts and powerboats up to 20 metres these Port and Starboard lamps combine style and functionality to ensure any vessel can operate at night.

- Minimum visible distance of 1 nautical mile at 112.5 degrees.
- Meets EMC EN60945, USCG & ABYC A-16 Standards.
- Surface mount, ideal for mounting on the top of the bow.
- Ultra reliable with over 50,000 hours life.
- IP67 - fully sealed and sea/salt spray resistant.

PRODUCT CODE  
**99082BL**



**NARVA**  
CHROME COVER  
TO SUIT 99080BL

Chrome Cover to suit 99080.

PRODUCT CODE  
**99090BL**



**NARVA**  
CHROME COVER  
TO SUIT 99082BL

Chrome Covers to suit 99082 (pair).

PRODUCT CODE  
**99092BL**



**NARVA**  
**9-33V**  
**3NM MAST HEAD FOREDECK LAMP**

An ideal solution for yachts and powerboats up to 20 metres. Provides approved masthead function with additional foredeck illumination.

- Minimum visible distance of 3 nautical miles (masthead) with 225 degree visible angle.
- Meets EMC EN60945, USCG & ABYC A-16 Standards.
- Flexible mounting wings for mounting on a variety of mast profiles.
- Illuminates large areas of deck or superstructure.
- Ultra reliable with over 50,000 hours life.
- IP67 – fully sealed and sea/salt spray resistant.

PRODUCT CODE  
**99104BL**



**NARVA**  
**9-33V**  
**2NM MAST HEAD LAMP**

Ideal for yachts and powerboats up to 12 metres.

- Minimum visible distance of 3 nautical miles (masthead) with 225 degree visible angle.
- Meets EMC EN60945, USCG & ABYC A-16 Standards.
- Surface mount.
- Ultra reliable with over 50,000 hours life.
- IP67 – fully sealed and sea/salt spray resistant.

PRODUCT CODE  
**99106BL**



**NARVA**  
**9-33V**  
**8IN FOLD DOWN ANCHOR LAMP**

When boating at night an Anchor lamp is required to be illuminated if a vessel is anchored. This fold down Anchor lamp allows the lamp to be easily stowed out of the way when not in operation.

- White L.E.D illumination with a minimum visible distance of 3 nautical miles.
- 360 degree visible angle.
- Meets EMC EN60945, USCG & ABYC A-16 Standards.
- Easy to mount with 8 inch pole.
- Ideal for yachts and powerboats up to 50 metres.
- Ultra reliable with over 50,000 hours life.
- IP67 – fully sealed and sea/salt spray resistant.

PRODUCT CODE  
**99140BL**



**NARVA**  
**9-33V**  
**12IN FOLD DOWN ANCHOR LAMP**

When boating at night an Anchor lamp is required to be illuminated if a vessel is anchored. This fold down Anchor lamp allows the lamp to be easily stowed out of the way when not in operation.

- White L.E.D illumination with a minimum visible distance of 3 nautical miles.
- 360 degree visible angle.
- Meets EMC EN60945, USCG & ABYC A-16 Standards.
- Easy to mount with 8 inch pole.
- Ideal for yachts and powerboats up to 50 metres.
- Ultra reliable with over 50,000 hours life.
- IP67 – fully sealed and sea/salt spray resistant.

PRODUCT CODE  
**99142BL**



**NARVA**  
**9-33V**  
**34-60IN PLUG-IN ANCHOR LAMP**

When boating at night an Anchor lamp is required to be illuminated if a vessel is anchored. This fold down Anchor lamp allows the lamp to be easily stowed out of the way when not in operation and is designed specifically for vessels without a canopy.

- White L.E.D illumination with a minimum visible distance of 3 nautical miles.
- 360 degree visible angle.
- Meets EMC EN60945, USCG & ABYC A-16 Standards.
- Securely plugs in & allows quick & easy removal & stowage.
- Telescopic pole extends up to 60 inches in length & quickly retracts to only 34 inches.
- Ideal for yachts and powerboats up to 50 metres.
- Ultra reliable with over 50,000 hours life.
- IP67 – fully sealed & sea/salt spray resistant.

PRODUCT CODE  
**99144BL**



**NARVA**  
**9-33V**  
**3NM LED ALL ROUND LAMP**

When boating at night an Anchor lamp is required to be illuminated if a vessel is anchored.

- White L.E.D illumination with a minimum visible distance of 3 nautical miles.
- 360 degree visible angle.
- Meets EMC EN60945, USCG & ABYC A-16 Standards.
- Ideal for yachts and powerboats up to 50 metres.
- Ultra reliable with over 50,000 hours life.
- IP67 – fully sealed and sea/salt spray resistant.

PRODUCT CODE  
**99146BL**



**PROJECTA**  
**12V SURE BRAKE**  
**EMERGENCY TRAILER BREAKAWAY KIT**

Projecta has released its new Sure Brake Trailer Breakaway Kit, which ensures safety in a towing disconnection emergency. The TBS700 Sure Brake accomplishes this with a durable, all-in-one case that houses its own 12V battery and charger and can be installed out of view, leaving only the plunger, lanyard and carabiner visible. The battery case can be hard wired to the tow vehicle alternator or charged externally via its terminal posts on the front, ensuring its 12V 7A battery always has charge. A test button allows for easy checking of battery status and there is a remote monitoring output wire for those who wish to install the battery case out of reach or monitor from the tow vehicle cabin.

- Built in 12V 7Ah sealed lead-acid battery
- Charged via: House battery of trailer, alternator of tow vehicle or external battery charger
- Push to test function
- Fused battery connection
- Potted circuitry
- Overvoltage, overcurrent and short circuit protection ensuring the safety of the system and its battery
- Pre-wired, colour-coded inputs and outputs and supplied mounting screws offer ease of installation

PRODUCT CODE  
**TBS700**



**NARVA**  
**12/24V 6M NO-PLUG**  
**AMBER LED MARKER LAMP**

The 12/24V amber marker lamps are protected from water ingress with a two stage sealing system that incorporates ultrasonic welding and a two-part epoxy glue. This allows the lamps to comply with the stringent IP68 standard. The marker lamp has a 6 meter lead.

PRODUCT CODE  
**91338-6**



**NARVA**  
**9-33V MODEL 41 LED**  
**SUBMERSIBLE TRAILER LAMP PACK**

Designed around the popular Model 42 range of rear combination lamps, the Model 41 family boasts all the same features as their larger counterpart but in a smaller more compact package.

- Virtually unbreakable polycarbonate lens
- In-built retro reflector, 2 lamps and a 9-33 Volt licence plate lamp
- 9m hard wired tinned cable for increased corrosion resistance
- Fully submersible

PRODUCT CODE  
**94142TP**



**NARVA**  
**1M 5 PIN TRAILER PLUG**  
**PLUG & PLAY EXTENSION**

The Model 37 plug and play trailer plug has a 5 pin extension along with a 1 meter lead.

PRODUCT CODE  
**93790**



**NARVA**  
**1M 2 PIN MARKER LAMP**  
**PLUG & PLAY EXTENSION**

The Model 37 plug and play trailer plug has a 2 pin extension along with a 1 meter lead.

PRODUCT CODE  
**93792**



**NARVA**  
**BLANKING CAPS**  
**FOR TRAILER LAMPS**

Blanking caps to suit Model 37 plug and play marker lamp.

PRODUCT CODE  
**TW-PPCAP**



**NARVA**  
**12/24V MODEL 37 LED**  
**PLUG & PLAY TRAILER LAMP KIT**

Model 37 trailer lamps are protected from water ingress with a two-stage system that incorporates ultrasonic welding and a two-part epoxy glue.

- A complete 'Plug and Play' solution for boat trailers making installation easier and quicker. Perfect for DIY installation.
- Each kit contains all the necessary lamps to comply a standard boat trailer to the Australian Design Regulations (ADR 13/00) for lighting installations.
- Waterproof connection system utilises over-moulded connectors that quickly join the lamps and trailer plug to the main wiring harness.
- No splicing or joining of wires is required, making connections a tool free operation.
- The Kit contains two 12/24V rear combination lamps (93732-9 & 93736-9), two amber LED side marker lamps, main harnesses and a 7-pin flat plug.

PRODUCT CODE  
**93750BL2-NZ** BLISTER PACK  
**93750NZ** BOXED  
**93732-9** REPLACEMENT LAMP  
**93736-9** REPLACEMENT LAMP WITH LICENCE PLATE



**WILDCAT**  
**RUBBER NUMBER PLATE HOLDER**  
**TO SUIT MODEL 37**

The flexible Wildcat rubber number plate mount has been designed to suit the Narva model 37 trailer lamps. It minimises damage by allowing the number plate to move freely when negotiating uneven surfaces.

- Made in New Zealand of durable 3mm rubber.
- 290mm x 105mm.

PRODUCT CODE  
**47 NPHOLDER**



**NARVA WHITE HEAVY DUTY DUAL USB SURFACE MOUNT SOCKET**

White for RV and Marine application.

- For exterior applications the white versions are potted with urethane for waterproofing.
- Please mount the housing with the opening facing down

PRODUCT CODE  
**81154WBL**



**NARVA 12V HEAVY DUTY POWER ACCESS SURFACE SOCKET**

White for RV and marine application.

- For exterior applications please mount the housing with the opening facing down

PRODUCT CODE  
**81025W**  
**81025WBL BLISTER PACK**



**NARVA HEAVY DUTY SURFACE MOUNT ACCESSORY/DUAL USB SOCKETS**

White for RV and Marine application.

- For exterior applications the white USB versions are potted with urethane for waterproofing.
- Please mount the housing with the opening facing down

PRODUCT CODE  
**81168WBL**



**NARVA THERMOPLASTIC MERIT SOCKET**

Non-corrosive plastic body, ideal for marine applications. Fitted with push on terminals. (Use P/No. 56252 connector housing for ideal connection)

- Amperage rating 16A at 12V and 8A at 24V.

PRODUCT CODE  
**82103BL**



**NARVA WHITE DUAL USB HEAVY DUTY ACCESSORY SOCKET**

Reliable performance and safe usage for charging or powering accessories and devices on the go. With a flush mount factory finish and durable dust proof cover offering quality powering capabilities, this HDRV socket is suitable for any exterior or interior application.

- Suitable for interior or exterior fitment.
- Features dust proof cover and stylish surface mount plastic housing.
- Flush mount for factory finish.
- Can be installed with or without the mounting panel.

PRODUCT CODE  
**81134WBL**



**NARVA HEAVY DUTY TWIN SURFACE MOUNT ACCESSORY SOCKETS**

White for RV and marine application.

- For exterior applications mount the housing with the opening facing down

PRODUCT CODE  
**81160WBL**



**NARVA HEAVY DUTY ACCESSORY SOCKET**

Reliable performance and safe usage for charging or powering accessories and devices on the go. With a flush mount factory finish and durable dust proof cover offering quality powering capabilities, this HDRV socket is suitable for any exterior or interior application.

- Suitable for interior or exterior fitment.
- Features dust proof cover and stylish surface mount plastic housing.
- Flush mount for factory finish.
- Can be installed with or without the mounting panel.

PRODUCT CODE  
**81026WBL**



**NARVA PUSH/PULL OFF/ON BRASS SWITCH**

SPST, brass construction, chrome knob Screw terminals Amperage rating 15A at 12V, 7.5A at 24V Mounting opening 10mm dia.

- SPST, brass construction, chrome knob .
- Screw terminals.
- Amperage rating 15A at 12V, 7.5A at 24V.
- Mounting hole 10mm dia.

PRODUCT CODE  
**60016BL**



**NARVA MOMENTARY ON PUSH BUTTON MARINE SWITCH**

SPST, brass construction, chrome knob Screw terminals Amperage rating 15A at 12V, 7.5A at 24V Mounting opening 16mm dia.

- SPST, brass construction, chrome knob.
- Screw terminals.
- Amperage rating 15A at 12V, 7.5A at 24V.
- Mounting hole 16mm dia.

PRODUCT CODE  
**60031BL**



**NARVA ON/OFF MARINE TOGGLE SWITCH**

SPST, brass construction, chrome plated toggle screw terminals. Amperage rating 20A at 12V, 10A at 24V. Mounting opening 11mm dia.

- SPST, brass construction, chrome plated toggle screw terminals.
- Amperage rating 20A at 12V, 10A at 24V.
- Mounting hole 11mm dia.

PRODUCT CODE  
**60062BL**



**NARVA ROTARY BATTERY MASTER SWITCH**

A compact switch at just 45mm round, requiring a mounting opening of just 29mm diameter. Easy turn knob that is ideally suited for use with passenger cars, light trucks and stationary engines.

- Includes alternative insert.
- IP56 Rated.

PRODUCT CODE  
**61036** 100A  
**61036BL** 100A BLISTER PACK  
**61043** 200A  
**61043BL** 200A BLISTER PACK

**NARVA REPLACEMENT BATTERY SWITCH KNOB**

Replacement red knob to suit 61036 and 61043.

PRODUCT CODE  
**61037** RED  
**61040** YELLOW



**NARVA PLASTIC BATTERY MASTER SWITCH WITH REMOVABLE KEY**

For passenger cars, light trucks, boats and stationary engines.

- 1000A at 12V for 5 seconds, 500A at 24V for 5 seconds .
- 100A at 12V continuous load maximum, 50A at 24V continuous load maximum.

PRODUCT CODE  
**61038**  
**61038BL BLISTER PACK**

**NARVA REPLACEMENT PLASTIC KEY**

Suits 61038.

PRODUCT CODE  
**61039**



**NARVA AUTOMOTIVE/MARINE BATTERY SWITCH MASTER**

Nickel plated with solid copper terminals for superior corrosion resistance. Ideal for automotive and marine applications exposed to salt water and other harsh environmental conditions (IP67).

- 1000A at 12V for 5 seconds, 500A at 24V for 5 seconds.
- 300A at 12V continuous load maximum, 150A at 24V continuous load maximum.

PRODUCT CODE  
**61044BL**



**NARVA 300A ROTARY BATTERY MASTER SWITCH WITH REMOVABLE KEYED KNOB**

A compact switch at just 55mm round, requiring a mounting opening of just 49.5mm diameter. Features an easy turn knob, ideally suited for use with passenger cars, light trucks and stationary engines. IP56 rated

- 1000A at 12V for 30 seconds, 500A at 24V for 30 seconds.
- 300A at 12V continuous load maximum, 150A at 24V continuous load maximum.

PRODUCT CODE  
**61045**  
**61045BL BLISTER PACK**



**NARVA KEY TYPE OFF/ON BATTERY SWITCH**

Features brass terminals and heavy-duty plastic construction making it ideal for marine applications or automotive requirements where the switch is exposed to the weather.

- Suitable for applications up to 48VDC.
- 1500A at 12V for 10 seconds, 750A at 24V for 10 seconds.
- 300A at 12V continuous load maximum, 150A at 24V continuous load maximum.

PRODUCT CODE  
**61078BL**

**NARVA REPLACEMENT KEY TO SUIT 61078**

Suits 61078BL.

PRODUCT CODE  
**61079**



**NARVA ROTARY STYLE BATTERY MASTER SWITCH**

Features brass terminals and heavy-duty plastic construction making it ideal for marine applications or automotive requirements where the switch is exposed to the weather.

- Suitable for applications up to 48VDC.
- 1500A at 12V for 10 seconds, 750A at 24V for 10 seconds.
- 300A at 12V continuous load maximum, 150A at 24V continuous load maximum.

PRODUCT CODE  
**61082BL**



**NARVA ROTARY STYLE BATTERY MASTER SWITCH WITH 4 POSITIONS**

Features brass terminals and heavy-duty plastic construction making it ideal for marine applications. Suitable for applications up to 48VDC. Has a 4 Position feature – Battery 1 and 2, Battery 1, Battery 2, Off.

- 1500A at 12V for 10 seconds, 750A at 24V for 10 seconds.
- 300A at 12V continuous load maximum, 150A at 24V continuous load maximum.

PRODUCT CODE  
**61084BL**



**NARVA HEAVY DUTY ROTARY STYLE BATTERY MASTER SWITCH WITH 4 POSITIONS**

For heavy-duty automotive and marine applications. 4 Position feature – Battery 1 and 2, Battery 1, Battery 2, Off.

- 500A at 12V for 5 minutes, 250A at 24V for 5 minutes.
- 310A at 12V continuous load maximum, 155A at 24V continuous load maximum.

PRODUCT CODE  
**61090**



**NARVA 3 POSITION SWITCH IGNITION**

Corrosion proof plastic construction with brass screw terminals, suitable for marine applications. Spring return action for start. Supplied with two encapsulated keys. Mounting opening 21mm dia.

- Amperage ratings at 12V:.
- 10A Ignition, 5A Start, 1A Choke.

PRODUCT CODE  
**64008**



**NARVA 4 POSITION HEAVY DUTY SWITCH IGNITION**

Heavy-duty brass construction with screw terminals, suitable for marine applications. Supplied with two encapsulated keys. Spring return action for start. Mounting opening 21mm dia.

- Amperage ratings at 12V:.
- 10A Accessories, 5A Ignition, 5A Start.

PRODUCT CODE  
**64012**



**NARVA 12V 140A VOLTAGE SENSITIVE RELAY**

Automatically connects and disconnects an appliance or circuit at the pre-set input voltage. Ideal for dual battery systems or to switch high current appliances. Features surge protection, L.E.D indicator, silver tipped contacts for durability.

- Cut-in: 13.3V Cut-out: 12.7V (5 second delay).
- 160A at 12V for 60 seconds, 140A at 12V continuous load maximum.

PRODUCT CODE  
**61092BL**



**NARVA 4-WAY LED SWITCH PANEL WITH CIRCUIT BREAKER PROTECTION**

SPST, illumination Amperage rating 20A at 12V, 10A at 24V Mounting openings: 108 x 83mm Overall Panel Dimensions: 130 x 100mm Circuit Breakers: 2 x 10A (P/No. 55310) 2 x 15A (P/No. 55315)

- Amperage rating 20A at 12V and 10A at 24V.

PRODUCT CODE  
**63191**



**NARVA 6-WAY LED SWITCH PANEL WITH FUSE PROTECTION**

SPST, illumination Amperage rating 20A at 12V, 10A at 24V Mounting opening: 157 x 93mm Overall Panel.

Dimensions: 183 x 120mm.

- Amperage rating 20A at 12V and 10A at 24V.

PRODUCT CODE  
**63193**



**NARVA 6-WAY LED SWITCH PANEL WITH CIRCUIT BREAKER PROTECTION**

SPST, illumination Amperage rating 20A at 12V, 10A at 24V Mounting opening: 160 x 83mm Overall Panel Dimensions: 183 x 100mm Circuit Breakers: 3 x 10A (P/No. 55310) 3 x 15A (P/No. 55315)

- Amperage rating 20A at 12V and 10A at 24V.

PRODUCT CODE  
**63194**



**NARVA 4-WAY LED SWITCH PANEL WITH FUSE PROTECTION**

SPST, illumination Amperage rating 20A at 12V, 10A at 24V Mounting opening: 105 x 93mm Overall Panel Dimensions: 130 x 120mm.

- Amperage rating 20A at 12V and 10A at 24V.

PRODUCT CODE  
**63190**



**NARVA 8-WAY LED SWITCH PANEL WITH FUSE PROTECTION**

SPST, illumination Amperage rating 20A at 12V, 10A at 24V Mounting opening 209 x 93mm Overall Panel Dimensions: 235 x 120mm.

- Amperage rating 20A at 12V and 10A at 24V.

PRODUCT CODE  
**63196**



**NARVA WATERPROOF SWITCH PANEL**

Ideal for boats, caravans and RVs where switches need to be protected from the elements. Replaceable clip-on contour wave cover, available in Blue & Grey. L.E.D back lit labels identify the correct switch. Switch function: 2P SPST On/Off x4.

- Mounting hole: 86 x 40mm.

PRODUCT CODE  
**63198BL**





**NARVA  
12/24V  
LED ROCKER SWITCHES**

Push-fit design with push on terminals, 'Light' & 'On' illumination of symbol. 12/24V – amperage rating 20A at 12V, 10A at 24V  
Mounting opening: 37.5 x 21mm.

**OFF/ON**

- SPST

PRODUCT CODE  
**63158BL** RED  
**63159BL** BLUE

**OFF/MOMENTARY ON**

- SPST

PRODUCT CODE  
**63164BL** RED  
**63165BL** BLUE

**ON/ON**

- DPDT

PRODUCT CODE  
**63166BL** RED  
**63167BL** BLUE



**NARVA  
RV & MARINE BLACK  
STICKER SWITCH SET**

Select from 50 popular RV & Marine symbols (black) to customise your L.E.D illuminated switch actuator.

PRODUCT CODE  
**63178BL**

**ON/OFF/ON**

- DPDT

PRODUCT CODE  
**63168BL** RED  
**63169BL** BLUE

**OFF/ON/ON**

- DPDT

PRODUCT CODE  
**63170BL** RED  
**63171BL** BLUE

**MOMENTARY ON/OFF/  
MOMENTARY ON**

- DPDT

PRODUCT CODE  
**63172BL** RED  
**63173BL** BLUE



**NARVA  
12/24V OFF/ON  
BLUE LED ILLUMINATED  
ROCKER SWITCH**

These Laser Etched L.E.D Rocker switches feature non-polarised L.E.Ds and are multi-voltage so they can be connected either way regardless of polarity or voltage. The Laser Etched actuator combined with the intensity of L.E.D provides a clearly identifiable back lit illumination and more detailed symbol.

- SPDT, push-fit design with push on terminals, 'Dash Light' & 'On' illumination.

PRODUCT CODE  
**63254BL**



**NARVA  
12/24V OFF/ON  
LED ILLUMINATED ROCKER  
SWITCH WITH ANCHOR  
LIGHTS SYMBOL**

These Laser Etched L.E.D rocker switches feature non-polarised L.E.Ds. Multi-voltage so can be connected either way regardless of polarity or voltage. The Laser Etched actuator combined with the intensity of L.E.D provides a clearly identifiable back lit illumination and more detailed symbol.

- SPDT, push-fit design with push on terminals, 'Dash Light' & 'On' illumination.

PRODUCT CODE  
**63255BL**



**NARVA  
12/24V DUAL USB  
BLUE LED  
ILLUMINATED SOCKET**

A powerful dual USB socket capable of charging/powering multiple devices simultaneously. Designed to match the laser etched rocker switches for a uniform look when banked together, or can be installed independently for a factory fit and finish.

- Output 5V at 3.1A.
- Illuminated Sockets and symbols (Blue).
- Mounting Opening: 37.5 x 21mm.

PRODUCT CODE  
**63218BL**



**NARVA  
ROCKER SWITCH OFF/ON  
RED LED WINCH**

SPDT, push-fit design with push on terminals, 'Light' & 'On' illumination Amperage rating 20A at 12V, 10A at 24V  
Mounting opening: 37.5 x 21mm.

- Amperage rating 20A at 12V and 10A at 24V.

PRODUCT CODE  
**63236BL**



**NARVA  
ROCKER SWITCH OFF/ON  
BLUE LED WINCH**

DPDT, push-fit design with push on terminals and illumination Amperage rating 20A at 12V, 10A at 24V  
Mounting opening: 37.5 x 21mm.

- Amperage rating 20A at 12V and 10A at 24V.

PRODUCT CODE  
**63238BL**



**NARVA  
ROCKER SWITCH OFF/ON  
BLUE LED LIGHT**

SPDT, push-fit design with push on terminals, 'Light' & 'On' illumination Amperage rating 20A at 12V, 10A at 24V  
Mounting opening: 37.5 x 21mm.

- Amperage rating 20A at 12V and 10A at 24V.

PRODUCT CODE  
**63224BL**



**NARVA  
ROCKER SWITCH OFF/ON  
BLUE LED AUX LIGHTS**

SPDT, push-fit design with push on terminals, 'Light' & 'On' illumination Amperage rating 20A at 12V, 10A at 24V  
Mounting opening: 37.5 x 21mm.

- Amperage rating 20A at 12V and 10A at 24V.

PRODUCT CODE  
**63232BL**



**NARVA  
12/24V OFF/ON  
LED ILLUMINATED ROCKER  
SWITCH WITH NAV LIGHTS  
SYMBOL**

These Laser Etched L.E.D Rocker switches feature non-polarised L.E.Ds and are multi-voltage so they can be connected either way regardless of polarity or voltage. The Laser Etched actuator combined with the intensity of L.E.D provides a clearly identifiable back lit illumination and more detailed symbol.

- SPDT, push-fit design with push on terminals, 'Dash Light' & 'On' illumination.

PRODUCT CODE  
**63256BL**



**NARVA  
12/24V OFF/ON  
LED ILLUMINATED ROCKER  
SWITCH WITH INTERIOR  
LIGHTS SYMBOL**

These Laser Etched L.E.D Rocker switches feature non-polarised L.E.Ds and are multi-voltage so they can be connected either way regardless of polarity or voltage. The Laser Etched actuator combined with the intensity of L.E.D provides a clearly identifiable back lit illumination and more detailed symbol.

- SPDT, push-fit design with push on terminals, 'Dash Light' & 'On' illumination.

PRODUCT CODE  
**63257BL**



**NARVA  
12/24V OFF/ON  
LED ILLUMINATED ROCKER  
SWITCH WITH BILGE PUMP  
SYMBOL**

These Laser Etched L.E.D Rocker switches feature non-polarised L.E.Ds and are multi-voltage so they can be connected either way regardless of polarity or voltage. The Laser Etched actuator combined with the intensity of L.E.D provides a clearly identifiable back lit illumination and more detailed symbol.

- SPDT, push-fit design with push on terminals, 'Dash Light' & 'On' illumination.

PRODUCT CODE  
**63258BL**

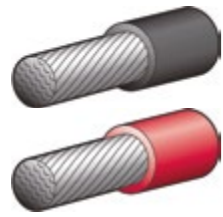

**NARVA 255A 2 B&S SINGLE CORE 30M BATTERY CABLE**

The Narva cable uses oxygen free copper and RoHS compliant polyvinyl-chloride.

- Coloured single core cable and battery cable.

PRODUCT CODE  
**5802M-30BK** BLACK  
**5802M-30RD** RED



**NARVA 4MM 15A 30M MARINE CABLE**

The Narva cable uses oxygen free copper and RoHS compliant polyvinyl-chloride.

- Coloured single core marine cable.

PRODUCT CODE  
**5814M-30BK** BLACK  
**5814M-30RD** RED

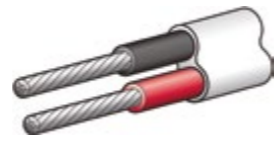

**NARVA 15A 4MM 30M MULTI-CORE BATTERY CABLE**

The Narva cable uses oxygen free copper and RoHS compliant polyvinyl-chloride.

- Red/Black Multicore Cable & Battery Cable 4.0mm with White Sheath.

PRODUCT CODE  
**5824M-30TW**



**NARVA 2MM 4A 30M MARINE CABLE**

The Narva cable uses oxygen free copper and RoHS compliant polyvinyl-chloride.

- Coloured single core marine cable.

PRODUCT CODE  
**5812M-30BE** BLUE  
**5812M-30BK** BLACK  
**5812M-30BN** BROWN  
**5812M-30GN** GREEN  
**5812M-30RD** RED  
**5812M-30WE** WHITE  
**5812M-30YW** YELLOW

**NARVA 100A 8 B&S SINGLE CORE 30 BATTERY CABLE**

The Narva cable uses oxygen free copper and RoHS compliant polyvinyl-chloride.

- Coloured single core cable and battery cable.

PRODUCT CODE  
**5808M-30BK** BLACK  
**5808M-30RD** RED



**NARVA 6MM 50A 30M MARINE CABLE**

The Narva cable uses oxygen free copper and RoHS compliant polyvinyl-chloride.

- Coloured single core marine cable.

PRODUCT CODE  
**5816M-30BK** BLACK  
**5816M-30RD** RED

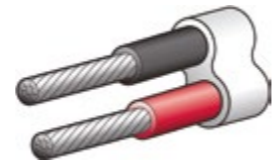

**NARVA 50A 6MM 30M MULTI-CORE BATTERY CABLE**

The Narva cable uses oxygen free copper and RoHS compliant polyvinyl-chloride.

- Red/Black Multicore Cable & Battery Cable 6.0mm with White Sheath.

PRODUCT CODE  
**5826M-30TW**

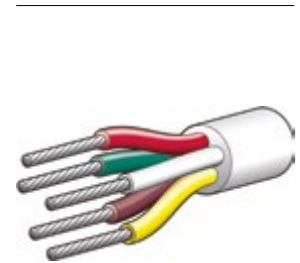

**NARVA 4AMP 2MM 30M 5 MULTI-CORE BATTERY CABLE**

The Narva cable uses oxygen free copper and RoHS compliant polyvinyl-chloride.

- Economy Cable.

PRODUCT CODE  
**5852M-30ETC**



**NARVA 15A 4MM 30M 3 MULTI-CORE BATTERY CABLE**

The Narva cable uses oxygen free copper and RoHS compliant polyvinyl-chloride.

- White/Yellow/Brown 3 Core Cable 4.0mm.

PRODUCT CODE  
**5834M-30WYB**

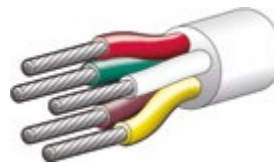

**NARVA 3MM 30M 5 MULTI-CORE CABLE MARINE**

The Narva cable uses oxygen free copper and RoHS compliant polyvinyl-chloride.

- 5 Core cable 3.0mm.

PRODUCT CODE  
**5853M-30TC**



**NARVA STAINLESS STEEL CABLE TIE PACKS**

Marine Grade 316. Easy to use.

PRODUCT CODE	SIZE	BUNDLE DIAMETER	QTY PER PACK
<b>56822</b>	4.6 X 200mm	51mm	50
<b>56922</b>	4.6 X 200mm	51mm	100
<b>56824</b>	4.6 X 360mm	102mm	50
<b>56924</b>	4.6 X 360mm	102mm	100
<b>56832</b>	7.9 X 360mm	102mm	50
<b>56834</b>	7.9 X 520mm	152mm	50
<b>56838</b>	7.9 X 840mm	254mm	50



**NARVA STAINLESS STEEL CABLE TIE TOOL**

A premium quality stainless steel cable tie tensioning tool that incorporates cutting blades in the tip which automatically and effortlessly cut the tie at the desired set tension. The tool is suitable for stainless steel cable ties up to 7.9mm wide and 0.3mm thick.

PRODUCT CODE  
**56503BL**



**NARVA WEATHERPROOF FUSE BOX**

A weatherproof/splashproof fuse box ideally suited to Marine, RV or exterior fitment type applications where prevention of dust, grime and water ingress is critical.

- Max Amps per Circuit: 25A at 12V.
- Max Amps per Block: 150A at 12V.
- Max Voltage: 32V DC.
- IP56 (when installed).
- Transparent screw tight cover.
- Suitable for use with standard ATS blade fuses.
- Suits panel mount applications.
- Pre-wired terminals.

PRODUCT CODE  
**54444BL**



**NARVA 10 WAY ATS LED FUSE BOX WEATHERPROOF**

A weatherproof/splashproof fuse box ideally suited to Marine, RV or exterior fitment type applications where prevention of dust, grime and water ingress is critical.

- Max Amps per Circuit: 25A at 12V.
- Max Amps per Block: 150A at 12V.
- Max Voltage: 32V DC.

PRODUCT CODE  
**54445BL**



**NARVA 6 WAY FUSE BOX WITH COVER**

A professional fuse box eliminates extensive and messy wiring in applications with limited earth connections such as caravans, motor homes and marine applications etc.

- Max Amps per Circuit: 30A at 12V.
- Max Amps per Block: 120A at 12V.
- Max Voltage: 32V DC.

PRODUCT CODE  
**54446BL**



**NARVA 12-WAY FUSE BOX WITH COVER**

A professional fuse box eliminates extensive and messy wiring in applications with limited earth connections such as caravans, motor homes and marine applications etc.

- Max Amps per Circuit: 30A at 12V.
- Max Amps per Block: 120A at 12V.
- Max Voltage: 32V DC.

PRODUCT CODE  
**54450BL**



**KICKER  
MARINE COMPACT  
DIGITAL MEDIA RECEIVER**

Equipped with an easily readable screen, rotary encoder and over 200 watts of total peak power into four channels, the KMC3 comes equipped with plenty of power. Add even more bump to your boat by adding amplifiers to the included RCA outputs.

- Fits in gauge opening.
- Uses USB, RCA, AM/FM and Bluetooth audio sources.
- USB audio playback or charging.
- RCA outputs.
- IP67 certification.
- Bluetooth Range: 30 feet.

PRODUCT CODE  
**80 46KMC3**



**KICKER  
MARINE DUAL ZONE  
DIGITAL MEDIA RECEIVER**

The KMC4 features four channels and up to 200 watts of built-in power. It comes equipped with an AM/FM/weather-band tuner, charging USB connection and four sets of RCA outputs for easy expansion. The KMC4 is ready for any music you want to play.

- Charging USB w/Thumb-Drive Playback
- Bluetooth Connectivity
- Full-Colour LCD Display
- 3in Hole Cutout
- KRC12 Remote Compatible
- AM/FM and Weather-Band Tuner
- Up to 10 Favorites for each source: AM and FM
- Front and Rear RCA Outputs, Plus Subwoofer and Zone 2
- AUX RCA Input

PRODUCT CODE  
**80 46KMC4**



**KICKER  
MARINE PREMIUM  
DIGITAL MEDIA RECEIVER**

Tons more fun for your cruise! KICKER's premier KMC5 Media Center features six channels of built-in power, delivering up to 240 watts to your speakers! Equipped with an AM/FM/satellite/weather-band tuner, charging USB connection and four sets of RCA outputs for easy expansion.

- Charging USB w/Thumb-Drive Playback
- Bluetooth Connectivity
- Full-Colour LCD Display
- SiriusXM ready
- 3in Hole Cutout
- Dedicated Zone 2 speaker outputs
- NMEA Port
- Video RCA Input with Remote trigger wire
- AM/FM and Weather-band Tuner

PRODUCT CODE  
**80 46KMC5**



**KICKER  
10IN 500W 4-OHM  
MARINE SUBWOOFER**

The KICKER KM 10-inch Marine Subwoofer makes waves of its own in a sealed or ported enclosure. Made to take the power and the weather, this sub is custom made to bang in your boat. Packed with features and made for specifically for marine use.

- Four-Ohm Voice Coil
- Injection-Molded Polypropylene Cone
- Co-molded Santoprene Surround
- UniPlate Back Plate And Pole Piece
- Thick Tinsel Leads
- Large Ceramic Magnet
- Rear Gasketing Included
- Polymer Basket Resists Corrosion
- Stainless Mounting Hardware Included

PRODUCT CODE  
**80 45KM102 2 OHM**  
**80 45KM104 4 OHM**



**KICKER  
6.75IN HIGH EFFICIENCY  
MARINE COMPONENT SPEAKER  
SYSTEM**

The KMS67 Tower System is a horn-loaded, compression-driver (HLCD), high-efficiency component system providing maximum sound quality and especially at a distance. The system is weather-proof with sealed cones, motor assemblies and UV-treated components.

- The system is weather-proof with sealed cones
- Peak: 400W, RMS: 200W

PRODUCT CODE  
**80 41KMS674C**



**KICKER  
6.75IN MARINE TOWER  
LONG THROW SPEAKER SYSTEM**

The KMT67 Tower System is a full-range, high-quality two-way speaker system with dual weather-proof, injection-moulded enclosures.

- Enclosures designed for either below- or above-the-bar mounting
- The system is weather-proof with sealed cones, motor assemblies and UV-treated components
- Dual midrange drivers (per enclosure) provide twice the cone area for big sound
- Billet-aluminum brackets and clamp inserts adjust to seven common sizes, matching most every wake tower or roll-bar diameter

PRODUCT CODE  
**80 41KMT674**



**KICKER  
6.5IN 195W COAXIAL  
MARINE SPEAKER PAIR**

Our speakers are made to thrive in the water. UV treatments on injection-moulded cones, Santoprene surrounds, baskets and grilles all help maintain top-shelf performance. KM speakers will endure almost any weather conditions with splash-and-spray-resistant sealed motors, cones and locking/sealed terminal covers.

- Four-Ohm voice coil
- 3/4-Inch titanium tweeter
- UV-treated polypropylene woofer with santoprene surround
- UV-resistant polymer basket
- Locking/sealed terminal cover
- Sealed motor structure
- 316l stainless mounting hardware included
- Charcoal and white grilles included

PRODUCT CODE  
**80 45KM654**



**KICKER  
6.5IN 195W COAXIAL LED  
MARINE SPEAKER PAIR**

These speakers are made to thrive in the water. UV treatments on injection-molded cones, Santoprene surrounds, baskets and grilles all help maintain top-shelf performance. KM speakers will endure almost any weather conditions with splash-and-spray-resistant sealed motors, cones and locking/sealed terminal covers.

- Spectacular full-range audio quality for your boat
- Multi-colour LED's can be changed to fit your mood
- Included with easy-to-match charcoal or white grilles
- Control LED colours with optional KMLC remote
- Peak: 195W, RMS: 65W

PRODUCT CODE  
**80 45KM654L**



**KICKER  
6.5IN WHITE 150W COAXIAL  
MARINE SPEAKER PAIR**

These powerful 6-1/2in speakers are tough enough for marine duty, but easy on your ears. The durable poly woofers and 1/2in balanced dome tweeters cut through wind, waves, and engine roar to deliver great sound without annoying harshness.

- 2-way 6-1/2in marine speakers (pair)
- UV-treated polypropylene woofer with Santoprene rubber surround
- 1/2in PEI film dome tweeter with neodymium magnet
- White grilles
- Sealed motor structure and locking terminal covers
- Power range: 2-50 watts RMS (150 watts peak power)
- Frequency response: 35-21,000 Hz
- Sensitivity: 90 dB

PRODUCT CODE  
**80 41KM604W**



**KICKER  
6.5IN DUAL WEATHER PROOF EMPTY  
TOWER SPEAKER ENCLOSURES 2PK**

Mount 6-inch KICKER speakers for external listening in marine and powersport applications with weather-proof KM-Series Tower-Speaker Empty Enclosures.

- Designed with a nine-degree axis rotation in either direction, allowing the speaker cans to be aimed in the most desirable location to deliver maximum sound quality.
- Includes polyfill, mounting hardware, aluminum tower-pipe clamps (2-5/8-inch)
- Three sizes of mounting adapters for the most popular pipe diameters (2-1/4, 2-3/8, 2-1/2)
- KICKER also offers the KMTAP Tower Enclosure Adapter Pack (sold separately) for fitting several other pipe sizes.

PRODUCT CODE  
**80 12KMTED**



**KICKER  
6.5IN BLACK WEATHER PROOF EMPTY  
TOWER SPEAKER ENCLOSURE 2PK**

Mounting powerful 6-inch KICKER speakers for external listening in marine and powersport applications just got easier with KICKER's durable and weather-proof KM-Series Tower-Speaker Empty Enclosures.

- Two enclosures per carton
- Tough ABS, weather-proof empty enclosures with slotted mounting holes for different bolt patterns
- Nine-degree axis rotation in either direction for aiming maximum sound quality
- Fits Mounting Tube Sizes
- Satin nickel plated brass binding posts (screw to tighten style)

PRODUCT CODE  
**80 12KMTES**



**KICKER  
ADAPTER PACK FOR KMTES & KMTED  
TOWER ENCLOSURES**

The KMTAP Marine Enclosure Adapter Pack allows KICKER marine towers and empty enclosures to fit even more pipe sizes, assuring that we have the size you need! KMTAP is compatible with KMTES, KMTED and KMTES8 Speaker Enclosures.

- Black marine grade plastic
- Kit has the following adapter sizes: (4) 1 5/8in, (4) 1 3/4in, (4) 1 7/8in, (4) 2in

PRODUCT CODE  
**80 12KMTAP**

**KICKER  
LED LIGHTING REMOTE WITH  
RECEIVER MODULE**

Make your KICKER subs and speakers light up.

- 19 lighting modes and 20 colours to choose from
- Fade, brightness, speed/strobe and colour options

PRODUCT CODE  
**80 41KMLC**





**KICKER**  
**600W MONO MARINE AMPLIFIER**

Use this flexible KM marine subwoofer amplifier to power your bass with ease. Experience the perfect way to get bass on your boat! Use the remote level control to adjust the bass right from the dash and connect the full-range RCA outputs to expand your system!

- Class-D Power Supply
- Mono Amplifier
- Conformal-Coated Circuit Board
- Remote Level Control Included
- Variable 12dB Crossover
- KickEQ Variable 12dB Bass Boost
- 24dB Subsonic Filter
- 316L Stainless-Steel Hardware Included

PRODUCT CODE  
**80 45KMA6001**

**KICKER**  
**800W MONO MARINE AMPLIFIER**

Purpose-built for your boat, every KM amp comes complete with marine-grade speaker terminals, stainless-steel screws, conformal-coated circuit boards and ABYC/NMMA-compliant power connections. Dialing in your sound is easy with KM amps - the amplifiers are also equipped with the KickEQ™ variable 12dB bass boost!

- Purpose-built for your boat, every KM amp comes complete with marine-grade speaker terminals, stainless-steel screws, conformal-coated circuit boards and ABYC/NMMA-compliant power connections.
- Dialing in your sound is easy with KMA amps. Variable 12dB crossovers are built in, plus a 24dB subsonic filter is also included on the KMA800.1 mono amplifier, and Amp 3 of the KMA600.6.
- This six-channel, 600-watt amp provides an easy way to get the perfect volume levels on (or off) the deck, in the water, or inside the cabin.

PRODUCT CODE  
**80 48KMA8001**



**KICKER**  
**4X90W 4-CHANNEL FULL RANGE MARINE AMPLIFIER**

Purpose-built for your boat, every KM amp comes complete with marine-grade speaker terminals, stainless-steel screws, conformal-coated circuit boards and ABYC/NMMA-compliant power connections. Dialing in your sound is easy with KM amps - the amplifiers are also equipped with the KickEQ™ variable 12dB bass boost!

- Purpose-built for your boat, every KM amp comes complete with marine-grade speaker terminals, stainless-steel screws, conformal-coated circuit boards and ABYC/NMMA-compliant power connections.
- Dialing in your sound is easy with KMA amps. Variable 12dB crossovers are built in, plus a 24dB subsonic filter is also included on the KMA800.1 mono amplifier, and Amp 3 of the KMA600.6.
- This six-channel, 600-watt amp provides an easy way to get the perfect volume levels on (or off) the deck, in the water, or inside the cabin.

PRODUCT CODE  
**80 48KMA3604**

**KICKER**  
**6X100W 6 CHANNEL FULL RANGE MARINE AMPLIFIER**

Purpose-built for your boat, every KM amp comes complete with marine-grade speaker terminals, stainless-steel screws, conformal-coated circuit boards and ABYC/NMMA-compliant power connections. Dialing in your sound is easy with KM amps - the amplifiers are also equipped with the KickEQ™ variable 12dB bass boost!

- Purpose-built for your boat, every KM amp comes complete with marine-grade speaker terminals, stainless-steel screws, conformal-coated circuit boards and ABYC/NMMA-compliant power connections.
- Dialing in your sound is easy with KMA amps. Variable 12dB crossovers are built in, plus a 24dB subsonic filter is also included on the KMA800.1 mono amplifier, and Amp 3 of the KMA600.6.
- This six-channel, 600-watt amp provides an easy way to get the perfect volume levels on (or off) the deck, in the water, or inside the cabin.

PRODUCT CODE  
**80 48KMA6006**



**KICKER**  
**300W RMS 4-CHANNEL MARINE AMPLIFIER**

Use this flexible four-channel KM marine amplifier to power your system with ease and pump up the sound like only KICKER can! Using a Class-D power plant, this amp features a variable bass boost with KickEQ, giving you as much as 12dB of extra bump.

- Class-D Power Supply
- Four-Channel Amplifier With Bridging Capability
- Conformal-Coated Circuit Board
- Variable 12dB Crossover
- KickEQ Variable 12dB Bass Boost
- ABYC/NMMA-Compliant Power Connections
- 316L Stainless-Steel Hardware Included

PRODUCT CODE  
**80 45KMA3004**



**KICKER**  
**450W RMS 6 CHANNEL MARINE AMPLIFIER**

Use this flexible KM six-Channel Marine Amplifier to power your system with ease and pump up the sound like only KICKER can! With this KM Six-Channel Amp, your boat is a floating concert!

- Class-D Power Supply
- Six-Channel Amplifier With Bridging Capability
- Three-Zone Control
- Full-Range Volume Controller Included
- Conformal-Coated Circuit Board
- Variable 12dB Crossover
- 24dB Subsonic Filter (Amp 3 Only)
- KickEQ Variable 12dB Bass Boost
- 316L Stainless-Steel Hardware Included

PRODUCT CODE  
**80 45KMA4506**

# KICKIN' BACK WITH KICKER®



Visit [kickernz.co.nz/marine-audio](http://kickernz.co.nz/marine-audio)

PRODUCT CODES

05 1101 BLACK..... 220  
 05 1102 WHITE..... 220  
 05 1103 RED..... 220  
 05 1104 MED BLUE..... 220  
 05 1106 GOLD..... 220  
 05 1107 SILVER..... 220  
 05 1199 CHROME..... 220  
 05 1201 BLACK..... 220  
 05 1202 WHITE..... 220  
 05 1203 RED..... 220  
 05 1207 SILVER..... 220  
 05 1299 CHROME..... 220  
 05 1501 BLACK..... 220  
 05 1506 GOLD..... 220  
 05 1601 BLACK..... 220  
 05 11301 BLACK..... 220  
 05 11303 RED..... 220  
 05 11307 SILVER..... 220  
 05 11399 CHROME..... 220  
 05 11401 BLACK..... 220  
 05 11403 RED..... 220  
 05 11499 CHROME..... 220  
 05 11600 RED-WHITE..... 220  
 05 11697 RED..... 220  
 7 AP6.....64  
 7 AP42B.....62  
 7 AP69.....63  
 7 AP70.....64  
 7 AP73.....66  
 7 AP77.....66  
 7 AP78.....65  
 7 AP81.....65  
 7 AP136.....64  
 7 AP149.....65  
 7 AP170.....60  
 7 AP195.....63  
 7 AP218SF.....60  
 7 AP253.....65  
 7 AP259.....60  
 7 AP266.....66  
 7 AP332.....67  
 7 AP333.....67  
 7 AP334.....67  
 7 AP336.....67  
 7 AP337.....67  
 7 AP339.....67  
 7 AP340.....67  
 7 AP342.....69  
 7 AP344.....68  
 7 AP346.....68  
 7 AP348A.....68  
 7 AP348B.....68  
 7 AP349.....69  
 7 AP349L.....69  
 7 AP971.....64  
 7 AP3421.....68  
 7 APA36.....72  
 7 APA47.....72  
 7 APA52.....73  
 7 APA53.....73  
 7 APA55.....71  
 7 APA56.....71  
 7 APA58.....70  
 7 APA59.....70  
 7 APA60.....70  
 7 APA63.....72  
 7 APA64.....72  
 7 APA65.....73  
 7 APA66.....70  
 7 APA67.....70  
 7 APA68.....71  
 7 APA69.....72  
 7 APA74.....71  
 7 APA75.....73  
 7 APA79.....71  
 7 APA81.....73  
 7 APA89.....72

7 ARF24B.....62  
 7 CBA2T1.....75  
 7 CBA3F1.....75  
 7 CBA3F1L.....75  
 7 CBA3FX.....76  
 7 CBA4S1.....76  
 7 CBA5T1.....76  
 7 CBA15.....75  
 7 CBA36.....75  
 7 CBA36F1L.....75  
 7 CBB3F1L.....76  
 7 CBBB3.....76  
 7 CBBF1B.....76  
 7 CBBL1.....77  
 7 CBBL2.....77  
 7 CBBU1.....77  
 7 CBBU2.....77  
 7 CBBV2.....77  
 7 CBMC.....77  
 7 CM12.....61  
 7 CMAS12.....61  
 7 CMAS13B.....61  
 7 CMR1.....61  
 7 EXT300N1.....68  
 7 EXT1200 1000MM.....67  
 7 EXT3000 3000MM.....67  
 7 FA14.....69  
 7 FRFW.....60  
 7 FRFWBK.....60  
 7 GG1.....62  
 7 MTB017.....65  
 7 MZ19.....63  
 7 MZ21.....63  
 7 MZMAST.....63  
 7 NB2MAST.....65  
 7 PM12.....62  
 7 PMCS12.....62  
 7 R400TB.....61  
 7 RU400.....62  
 7 RUR1M.....60  
 7 TH98.....66  
 7 THMAST.....66  
 7 TP96MAST.....66  
 7 VNMAST.....64  
 7 VW4100.....61  
 7 VY2MAST.....64  
 11 11616.....120  
 11 ABSS419.....121  
 11 IJFSB1.....120  
 11 ISFS.....120  
 11 TSMS.....120  
 11 WSCATCHP.....121  
 11 WSRM17LH.....121  
 14 ABFM850.....175  
 14 ABRM019.....177  
 14 CM10B.....174  
 14 CM21B.....175  
 14 CM22B.....174  
 14 CM30B.....175  
 14 CMCATBLKFR.....177  
 14 CMRMCBLS4.....175  
 14 CMRMWBLKFR.....177  
 14 LINKL LARGE.....177  
 14 LINKS SMALL.....177  
 14 RM10B.....176  
 14 RM20B.....176  
 14 RM50.....176  
 14 RM59.....176  
 14 RMFR12.....178  
 14 RMFR12D.....178  
 14 RMIDM17.....178  
 14 RMMBT16.....178  
 14 RMMT17.....179  
 14 RMNN16.....179  
 14 RMT16.....179  
 17 12226.....223  
 17 12243.....223  
 17 19950.....223  
 17 50000 5%.....183  
 17 50001 15%.....183

17 50002 35%.....183  
 17 60005 5%.....183  
 17 60015 15%.....183  
 17 60035 35%.....183  
 17 65005 5%.....183  
 17 65015 15%.....183  
 17 65035 35%.....183  
 17 AC54778 CARBON FIBRE.....115  
 17 AC54783 BLACK.....115  
 17 AC56056 BLUE.....115  
 17 AC56216 RED.....115  
 17 WTS005 5%.....183  
 18 4X4.....221  
 18 DRAGON.....221  
 18 LIMITED1.....221  
 18 PS007.....223  
 18 RACING.....221  
 18 SKULL.....221  
 18 SPORT.....221  
 18 SPORT1.....221  
 18 STRMWBLK BLACK.....222  
 18 STRMWBNE BONE.....222  
 18 STRMWPNK PINK.....222  
 18 STRMWRED RED.....222  
 18 STRMWSLV SILVER.....222  
 18 STRMWWHT WHITE.....222  
 18 TURBO.....221  
 18 V8.....221  
 18 ZBDSAB.....222  
 18 ZMLBVAB BLACK.....222  
 18 ZMLWVAB WHITE.....222  
 18 ZSTLWBAB.....222  
 18 ZUVAB.....222  
 19 EHF-18-450 450MM 18 INCH.....216  
 19 EHF-20-500 500MM 20 INCH.....216  
 19 EHF-22-560 560MM 22 INCH.....216  
 19 EHF-24-610 610MM 24 INCH.....216  
 19 EHF-26-650 650MM 26 INCH.....216  
 19 EU-14-350 350MM.....216  
 19 EU-15-380 380MM.....216  
 19 EU-16-400 400MM.....216  
 19 EU-17-425 425MM.....216  
 19 EU-18-450 450MM.....216  
 19 EU-19-475 475MM.....216  
 19 EU-20-500 500MM.....216  
 19 EU-21-525 525MM.....216  
 19 EU-22-560 560MM.....216  
 19 EU-24-610 610MM.....216  
 19 EU-26-650 650MM.....216  
 19 EU-28-700 700MM.....216  
 19 EU-ADAPT.....217  
 19 EX6MB650/20.....215  
 19 EX6MB710/10 6MM.....215  
 19 EX8MB710/10 8MM.....215  
 19 HOOK-14-350 350MM.....216  
 19 HOOK-15-380 380MM.....216  
 19 HOOK-16-400 400MM.....216  
 19 HOOK-17-425 425MM.....216  
 19 HOOK-18-450 450MM.....216  
 19 HOOK-19-475 475MM.....216  
 19 HOOK-20-500 500MM.....216  
 19 HOOK-21-525 525MM.....216  
 19 HOOK-22-560 560MM.....216  
 19 HOOK-24-610 610MM.....216  
 19 HOOK-26-650 650MM.....216  
 19 HOOK-28-700 700MM.....216  
 19 JAP-ADAPT.....217  
 19 OEXBB2202 BIG BLUE.....214  
 19 OEXBG2202 BIG GREY.....214  
 19 OEXJB2202 JET BLACK.....214  
 19 OEXMW2202.....214  
 19 OEXSE2202.....214  
 19 OWCS18 18 INCH.....215  
 19 OWCS20 20 INCH.....215  
 19 OWCS22 22 INCH.....215  
 19 OWRSE24620 6MM.....215  
 19 OWRSE24820 8.5MM.....215  
 19 V-ADAPT.....217  
 20 FGCCCLGE L - 480 X 175 X 120CM.....229  
 20 FGCCMED M - 430 X 160 X 120CM.....229

20 FGCCXLG XL - 530 X 175 X 120CM.....229  
 21 KF102.....189  
 21 KF103.....189  
 21 KF104.....189  
 21 KF105.....189  
 21 KF107.....189  
 21 KF108.....189  
 21 KF109.....189  
 21 KF113.....189  
 21 KF114.....190  
 21 KF120.....212  
 21 KF122.....212  
 21 KF123.....212  
 21 KF133.....190  
 21 KF134.....190  
 21 KF135.....190  
 21 KF136.....190  
 21 KF140.....187  
 21 KF141.....187  
 21 KF150.....190  
 21 KF160.....190  
 21 KF161.....190  
 21 KF162.....191  
 21 KF163.....191  
 21 KF165.....191  
 21 KF167.....191  
 21 KF168.....191  
 21 KF169.....191  
 21 KF200.....192  
 21 KF201.....192  
 21 KF202.....192  
 21 KF203.....192  
 21 KF204.....192  
 21 KF205.....192  
 21 KF212.....192  
 21 KF213.....192  
 21 KF214.....193  
 21 KF215.....193  
 21 KF216.....193  
 21 KF217.....193  
 21 KF218.....193  
 21 KF219.....193  
 21 KF220.....193  
 21 KF221.....193  
 21 KF222.....194  
 21 KF224.....194  
 21 KF225.....194  
 21 KF226.....194  
 21 KF227.....194  
 21 KF232.....194  
 21 KF233.....194  
 21 KF240.....194  
 21 KF241.....195  
 21 KF242.....195  
 21 KF243.....195  
 21 KF245.....195  
 21 KF249.....191  
 21 KF250.....200  
 21 KF251.....200  
 21 KF252.....200  
 21 KF253.....200  
 21 KF254.....200  
 21 KF256.....200  
 21 KF257.....200  
 21 KF259.....200  
 21 KF264.....201  
 21 KF266.....201  
 21 KF267.....201  
 21 KF268.....201  
 21 KF269.....201  
 21 KF270.....199  
 21 KF271.....199  
 21 KF273.....197  
 21 KF274.....197  
 21 KF276.....197  
 21 KF297.....204  
 21 KF298.....204  
 21 KF299.....204  
 21 KF300.....207  
 21 KF301.....202

21 KF302..... 204  
 21 KF303..... 202  
 21 KF304..... 204  
 21 KF305..... 204  
 21 KF306..... 204  
 21 KF307..... 204  
 21 KF308..... 205  
 21 KF309..... 205  
 21 KF310..... 202  
 21 KF311..... 202  
 21 KF312..... 187  
 21 KF313..... 187  
 21 KF314..... 207  
 21 KF315..... 207  
 21 KF316..... 207  
 21 KF317..... 207  
 21 KF318..... 208  
 21 KF319..... 208  
 21 KF320..... 208  
 21 KF321..... 208  
 21 KF322..... 208  
 21 KF323..... 208  
 21 KF324..... 208  
 21 KF325..... 208  
 21 KF326..... 209  
 21 KF327..... 209  
 21 KF328..... 209  
 21 KF329..... 209  
 21 KF330..... 197  
 21 KF331..... 209  
 21 KF332..... 209  
 21 KF333..... 209  
 21 KF334..... 197  
 21 KF335..... 197  
 21 KF336..... 197  
 21 KF337..... 197  
 21 KF338..... 198  
 21 KF339..... 198  
 21 KF340..... 188  
 21 KF343..... 188  
 21 KF344..... 199  
 21 KF345..... 188  
 21 KF346..... 188  
 21 KF347..... 188  
 21 KF348..... 188  
 21 KF350..... 195  
 21 KF360..... 196  
 21 KF361..... 196  
 21 KF362..... 196  
 21 KF363..... 196  
 21 KF364..... 196  
 21 KF365..... 196  
 21 KF366..... 196  
 21 KF367..... 196  
 21 KF368..... 201  
 21 KF369..... 201  
 21 KF370..... 201  
 21 KF371..... 198  
 21 KF373..... 202  
 21 KF374..... 202  
 21 KF375..... 202  
 21 KF376..... 202  
 21 KF377..... 203  
 21 KF378..... 203  
 21 KF379..... 198  
 21 KF380..... 206  
 21 KF381..... 206  
 21 KF382..... 206  
 21 KF386..... 203  
 21 KF387..... 206  
 21 KF388..... 206  
 21 KF389..... 206  
 21 KF390..... 206  
 21 KF395..... 207  
 21 KF396..... 207  
 21 KF397..... 207  
 21 KF400..... 205  
 21 KF401..... 205  
 21 KF410..... 209  
 21 KF411..... 210

21 KF412..... 210  
 21 KF415..... 210  
 21 KF416..... 210  
 21 KF417..... 210  
 21 KF420..... 210  
 21 KF422..... 210  
 21 KF423..... 210  
 21 KF425..... 211  
 21 KF426..... 211  
 21 KF428..... 211  
 21 KF429..... 211  
 21 KF430..... 203  
 21 KF431..... 205  
 21 KF432..... 203  
 21 KF433..... 203  
 21 KF436..... 203  
 21 KF440..... 198  
 21 KF450..... 211  
 21 KF451..... 211  
 21 KF452..... 211  
 21 KF453..... 211  
 21 KF454..... 212  
 21 KF455..... 212  
 21 KF460..... 199  
 21 KF461..... 199  
 21 KF480..... 199  
 21 KF481..... 199  
 21 KF491..... 187  
 21 KF900..... 212  
 21 KF901..... 212  
 21 KF910..... 212  
 21 KF911..... 213  
 21 KF920..... 213  
 21 KF921..... 213  
 21 KF930..... 213  
 21 KF935..... 213  
 21 KF940..... 213  
 21 KF945..... 213  
 21 KF949..... 213  
 29 AOS120 1200MM..... 231  
 29 AOS450 450MM..... 231  
 29 AOS600 600MM..... 231  
 29 AOS900 900MM..... 231  
 29 D8 8MM..... 231  
 29 D10 10MM..... 231  
 29 EK1..... 232  
 29 TD180-2..... 231  
 29 TR3..... 232  
 36 CTPOL..... 146  
 36 MF12 12MM..... 144  
 36 MF18 18MM..... 144  
 36 MF20 20MM..... 144  
 36 MF25 25MM..... 144  
 36 PAB..... 145  
 36 PAM..... 145  
 36 PAN2..... 145  
 36 PAS1..... 145  
 36 WS00277BL BLACK..... 144  
 36 WS00277C CHROME..... 144  
 36 WS00277CF CARBON FIBRE..... 144  
 36 WS00277R RED..... 144  
 36 WS24577B BLUE..... 144  
 36 WS24577R RED..... 144  
 42 1102S..... 117  
 42 1103S..... 117  
 42 AG307..... 117  
 42 AG307C..... 117  
 42 EGF..... 117  
 42 EGO..... 117  
 42 EGT..... 117  
 42 EGV..... 117  
 44 1529..... 227  
 44 1537..... 227  
 44 11973..... 226  
 44 19970 SILVER..... 227  
 44 19971 BLACK..... 227  
 44 19975 BLACK..... 227  
 44 119601..... 226  
 44 119603..... 226  
 44 AC56222..... 225

44 AC57371..... 225  
 44 G311BL..... 118  
 44 G1136A..... 118  
 44 G3411B..... 118  
 44 G3413G..... 118  
 44 G3520C..... 118  
 44 G3523S..... 118  
 44 G3597B..... 119  
 44 G6020..... 119  
 44 G6021..... 119  
 44 G6139..... 119  
 44 GB7302..... 119  
 44 P856B..... 116  
 44 P857B..... 116  
 44 P8543B..... 116  
 44 P8544B..... 116  
 44 P20457MBL..... 116  
 44 P20458ABL..... 116  
 45 ABNP217..... 229  
 45 NPBP BLACK..... 229  
 45 NPBU BLUE..... 229  
 45 NPCP CHROME..... 229  
 45 NPRD RED..... 229  
 45 NPSS..... 229  
 45 NPWW WHITE..... 229  
 45 TCPL LARGE..... 229  
 45 TCP STANDARD..... 229  
 46 370C..... 230  
 46 5961..... 230  
 46 BSM75..... 230  
 46 MIS..... 230  
 46 QFT96..... 230  
 47 ABA330S..... 101  
 47 AS720..... 232  
 47 BOOTORG..... 123  
 47 CC72..... 146  
 47 CC120..... 146  
 47 CL12B..... 233  
 47 CLD15..... 122  
 47 G5000..... 146  
 47 KSL12..... 122  
 47 KWL1..... 232  
 47 LK50 50MM..... 231  
 47 LK178 1-7/8 INCH..... 231  
 47 LPLATE..... 123  
 47 MFUNI..... 233  
 47 MRLHBL..... 230  
 47 MRWOF..... 230  
 47 NPHOLDER..... 361  
 47 PETS..... 123  
 47 PLSSR..... 122  
 47 PLUNI..... 122  
 47 SR17..... 233  
 47 SR100..... 233  
 47 SR500..... 233  
 47 TBC..... 231  
 47 TOF..... 146  
 47 WRU1..... 146  
 47 YF612..... 123  
 48 10111..... 219  
 48 FC..... 232  
 48 JS12..... 219  
 48 JS353..... 219  
 48 M4N1..... 218  
 48 MFFF..... 218  
 48 MFLR..... 218  
 48 MGFF..... 218  
 48 MGLF 210MM..... 218  
 48 MGMF 150MM..... 218  
 48 MGOD..... 219  
 48 MGODH..... 219  
 48 MGSF 100MM..... 218  
 48 MGXF..... 218  
 48 PSB..... 219  
 48 PSTU..... 219  
 49 12325..... 185  
 49 12326..... 185  
 49 103960..... 184  
 49 111614..... 226  
 49 117151..... 185

49 117161..... 185  
 49 ABBP190..... 185  
 49 ABSW550..... 184  
 49 SWCATBLK..... 184  
 49 SWRMWBLK..... 184  
 50 AC50092..... 123  
 50 AP10QI..... 112  
 50 AP15QIW..... 112  
 50 AP20AQI..... 112  
 50 AP20AQIC INCL. CHARGER..... 112  
 50 AP5000WC..... 113  
 50 APDCCUP..... 112  
 50 APL3..... 113  
 50 APL3USB..... 113  
 50 APL30USB..... 113  
 50 APL48S..... 113  
 50 APL50USB..... 113  
 50 APM3RP..... 114  
 50 APMMDASH..... 114  
 50 APMVLOK..... 114  
 50 APMWSHLD..... 114  
 50 APSMDASH..... 114  
 50 APSMSHLD..... 114  
 50 APSMVLOK..... 114  
 50 AWCTO1..... 112  
 50 BMA..... 231  
 50 DH11089..... 123  
 50 DPB..... 233  
 50 USBM21..... 58  
 50 USBM221..... 113  
 51 ABT510B..... 59  
 51 AP135..... 58  
 52 31449..... 111  
 52 32040..... 111  
 52 87800..... 111  
 52 ABRJ015..... 111  
 52 AF532320F REDLINE..... 109  
 52 AF532321F BURNOUT..... 109  
 52 AF532322F TREASURE HUNT..... 109  
 52 AF532323F BEACH BOMB..... 109  
 52 AF532324F RODGER DODGER..... 109  
 52 AF532325F SILVER BULLET..... 109  
 52 AF532326F REDLINE..... 109  
 52 AF532327F BURNOUT..... 109  
 52 AF532328F TREASURE HUNT..... 109  
 52 AF532329F BEACH BOMB..... 109  
 52 AF532330F RODGER DODGER..... 109  
 52 HIDE15ASST..... 108  
 52 HIDEIT11 BLACK MAGIC..... 108  
 52 HIDEIT13 VANILLA..... 108  
 52 HIDEIT17 STRAWBERRY..... 108  
 52 HIDEIT18 OUTDOOR BREEZE..... 108  
 52 HIDEIT19 WILDBERRIES..... 108  
 52 JJC001 BUBBLE GUM..... 106  
 52 JJC001S BUBBLE GUM SPARKLE..... 106  
 52 JJC002 CHERRY..... 106  
 52 JJC002S CHERRY SPARKLE..... 106  
 52 JJC003 BLUEBERRY..... 106  
 52 JJC003S BLUEBERRY SPARKLE..... 106  
 52 JJC005 VANILLA SPARKLE..... 106  
 52 JJC005 VANILLA..... 106  
 52 JJC006 STRAWBERRY..... 106  
 52 JJC12ASST..... 106  
 52 JH001 BUBBLE GUM..... 107  
 52 JH002 CHERRY..... 107  
 52 JH003 BLUEBERRY..... 107  
 52 JH004 GREEN APPLE..... 107  
 52 JH005 VANILLA..... 107  
 52 JH006 STRAWBERRY..... 107  
 52 JH007 ORANGE..... 107  
 52 JH008 LEMON..... 107  
 52 JH009 BANANA..... 107  
 52 JH12ASST..... 107  
 52 LEAF11-3 BLACK MAGIC - 3 PACK..... 108  
 52 LEAF11 BLACK MAGIC..... 108  
 52 LEAF13-3 VANILLA - 3 PACK..... 108  
 52 LEAF13 VANILLA..... 108  
 52 LEAF15 GREEN APPLE..... 108  
 52 LEAF17-3 STRAWBERRY - 3 PACK..... 108  
 52 LEAF17 STRAWBERRY..... 108

52 LEAF18-3 OUTDOOR BREEZE - 3 PACK ..... 108  
 52 LEAF18 OUTDOOR BREEZE ..... 108  
 52 LEAF19-3 WILDBERRIES - 3 PACK ..... 108  
 52 LEAF19 WILDBERRIES ..... 108  
 52 LEAF20 MOUNTAIN PINE ..... 108  
 52 LEAF42ASST ..... 108  
 52 LJMB001 VANILLA ..... 110  
 52 LJMB002 NEW CAR ..... 110  
 52 LJMB003 FRUIT PASSION ..... 110  
 52 LJMB004 CHERRY ..... 110  
 52 LJMB007 OCEAN SPLASH ..... 110  
 52 LJMEM02 NEW CAR ..... 110  
 52 LJMEM04 CHERRY ..... 110  
 52 LJMEM06 BLACK VELVET ..... 110  
 52 LJOK02N ..... 110  
 52 SPE001 LEMON ..... 111  
 52 SPE003 OCEAN SPLASH ..... 111  
 52 SPE005 FRUIT BLAST ..... 111  
 55 ABSC170 ..... 168  
 55 APHBTB BLACK ..... 166  
 55 APHBTL GREY ..... 166  
 55 CLFHBG ..... 166  
 55 CV4PCBL ..... 167  
 55 CV60BL ..... 167  
 55 CVCATBLK30 ..... 168  
 55 CVRMW16BLK30 BLACK ..... 169  
 55 CVRMW16GRY30 GREY ..... 169  
 55 GTXFHBG ..... 166  
 55 JCRMW16BLK30 ..... 169  
 55 JCRMW16BLK60 ..... 169  
 55 MHRMW16BLK06 ..... 170  
 55 MHRMW16BLK30 ..... 170  
 55 PCCATGRY30 ..... 168  
 55 RSFHBG ..... 167  
 55 RSRG ..... 167  
 55 SP1BL ..... 168  
 55 VLRMW16BLK06 ..... 170  
 55 VLRMW16BLK30 ..... 170  
 56 RPG1001.TRB BLACK ..... 172  
 56 RPG1001.TRG GREY ..... 172  
 56 RPG1002.TRB BLACK ..... 172  
 56 RPG1002.TRG GREY ..... 172  
 56 RPG1003.TRB BLACK ..... 172  
 56 RPG1003.TRG GREY ..... 172  
 56 RPG1004.TRG GREY ..... 172  
 56 RPG1005.TRB BLACK ..... 172  
 56 RPG1005.TRG GREY ..... 172  
 56 RPG1011.TRG GREY ..... 172  
 56 RPG1016.TRB BLACK ..... 172  
 56 RPG1016.TRG GREY ..... 172  
 56 RPG1022.TRB BLACK ..... 172  
 56 RPG1035.TRB BLACK ..... 172  
 56 RPG1036.TRG GREY ..... 172  
 56 RPG1067.TRG GREY ..... 172  
 56 RPG5001.TRB BLACK ..... 172  
 56 RPG5001.TRG GREY ..... 172  
 56 RPG5002.TRG GREY ..... 172  
 56 RPG5012.TRB BLACK ..... 172  
 56 RPG5012.TRG GREY ..... 172  
 56 RPG5014.TRG GREY ..... 172  
 56 RPG5018.TRB BLACK ..... 172  
 56 RPG5018.TRG GREY ..... 172  
 56 RPG5021.TRB BLACK ..... 172  
 56 RPG5023.TRB BLACK ..... 172  
 56 RPG5023.TRG GREY ..... 172  
 56 RPG5029.TRB BLACK ..... 172  
 56 RPG5029.TRG GREY ..... 172  
 56 RPG5073.TRG GREY ..... 172  
 57 91393 RED ..... 228  
 57 91394 AMBER ..... 228  
 57 91395 CLEAR ..... 228  
 57 CT5025GY ..... 228  
 57 PDST01 12MM ..... 228  
 57 PDST02 18MM ..... 228  
 57 STPBIL10 ..... 56  
 57 STPBSBP ..... 56  
 57 STPBSDP ..... 56  
 57 STPBSSK ..... 56  
 57 STPBSSP ..... 57  
 57 STPCRPRO ..... 57

57 STPHS10 ..... 57  
 57 STPMLTPE ..... 57  
 57 STPRL30 ..... 56  
 57 WS6 ..... 228  
 62 DS1001 ..... 157  
 62 DS1010 ..... 157  
 62 DS1011 ..... 157  
 62 DS1012 ..... 157  
 62 DS1013 ..... 157  
 62 DS1020 ..... 156  
 62 DS1030 ..... 156  
 63 AC55392 ..... 256  
 63 LM54893 ..... 256  
 63 LM55252M ..... 252  
 63 LM55258 ..... 258  
 63 LM55259 ..... 258  
 63 LM55323 ..... 257  
 63 LM55369M ..... 253  
 63 LM55391 ..... 253  
 63 LM55878 ..... 255  
 63 LM55879 ..... 252  
 63 LM55880 ..... 257  
 63 LM56245M ..... 254  
 63 LM56615 ..... 255  
 63 LM57485 ..... 254  
 63 SMD5MP ..... 259  
 63 SMD1000B ..... 259  
 64 31319 ..... 158  
 64 31999 ..... 159  
 64 600001 ..... 152  
 64 620034 ..... 153  
 64 620036 ..... 151  
 64 620161 ..... 153  
 64 630018 ..... 152  
 64 630022 ..... 152  
 64 630023 ..... 153  
 64 630035 ..... 153  
 64 630167 ..... 151  
 64 630168 ..... 151  
 64 630175 ..... 152  
 64 5071268 ..... 151  
 64 5080217 ..... 152  
 64 800001809 ..... 152  
 64 800001810 ..... 153  
 64 800002245 103ML ..... 151  
 64 800002250 473ML TRIGGER BOTTLE ..... 151  
 64 BCAF21112 ..... 151  
 64 RX11806D ..... 153  
 65 510011 ..... 140  
 65 510012 ..... 140  
 65 510013 ..... 140  
 65 510014 ..... 140  
 65 510015 ..... 140  
 65 510016 ..... 141  
 65 510018 ..... 141  
 65 510019 ..... 141  
 65 510021 ..... 141  
 65 510022 ..... 141  
 65 510023 ..... 141  
 65 510104 ..... 142  
 65 510105 ..... 142  
 65 510106 ..... 142  
 65 510152INTL ..... 142  
 65 540001 ..... 142  
 65 540023 ..... 142  
 65 750001 ..... 143  
 65 750002 ..... 143  
 65 5072866 ..... 140  
 65 800002230 ..... 143  
 65 800002231 ..... 143  
 65 800002241 ..... 143  
 66 2420 ..... 126  
 66 KBWBWH ..... 160  
 66 KBWEFT165 ..... 160  
 66 KBWW ..... 160  
 66 KBWWSPW ..... 160  
 66 KCPMT6PC ..... 161  
 66 KCTGC ..... 161  
 66 KHCLG ..... 161  
 66 KLC225 ..... 161

66 KLC375 ..... 161  
 66 KPP1M ..... 161  
 66 KSPG ..... 160  
 66 KSPJ ..... 160  
 66 RXCHL ..... 154  
 66 RXCWB ..... 155  
 66 RXDT ..... 154  
 66 RXEXT16 ..... 155  
 66 RXEXT21 ..... 155  
 66 RXEXTMOP13 ..... 154  
 66 RXEXTSQ13 ..... 154  
 66 RXJS ..... 154  
 66 RXSQS ..... 154  
 66 RXWBD ..... 155  
 66 RXWBLH ..... 155  
 66 RXWBM ..... 155  
 66 RXWCD ..... 154  
 66 RXWM ..... 154  
 66 SCR010 ..... 160  
 67 31371 ..... 159  
 67 31418 ..... 159  
 67 31432 ..... 159  
 67 120164 ..... 158  
 67 5072647 ..... 158  
 67 800002220 ..... 158  
 67 BM23 ..... 158  
 67 BM41023 ..... 158  
 67 DL ..... 143  
 68 61Z09 ..... 163  
 68 02012 ..... 162  
 68 11201 RED ..... 162  
 68 11203 BLACK ..... 162  
 68 11207 WHITE ..... 162  
 68 11209 CLEAR ..... 162  
 68 11212 GLOSSIFIER ..... 162  
 68 11217 CAMO GREEN ..... 162  
 68 11218 BLAZE ORANGE ..... 162  
 68 11220 SMOKE ..... 162  
 68 11221 GUNMETAL GREY ..... 162  
 68 11297 GLOSS BLACK ..... 163  
 68 11350 BLACK SAPPHIRE METALLIC ..... 163  
 68 11601 RED ..... 163  
 68 11602 YELLOW ..... 163  
 68 11603 BLACK ..... 163  
 68 11604 BLUE ..... 163  
 68 16003 ..... 163  
 68 LET14Z01 RED ..... 163  
 68 LET14Z03 BLACK ..... 163  
 69 100 ..... 159  
 69 400 200G ..... 159  
 69 500 500G ..... 159  
 69 2100 ..... 127  
 69 2110 ..... 127  
 69 2120 ..... 127  
 69 2130 ..... 127  
 69 6002TRI ..... 138  
 69 6522K ..... 138  
 69 8212 ..... 136  
 69 8217 ..... 136  
 69 8237 ..... 136  
 69 8257 28G ..... 136  
 69 8258 57G ..... 136  
 69 8265S ..... 136  
 69 8267S ..... 136  
 69 8271 ..... 137  
 69 8272 ..... 137  
 69 8276 ..... 137  
 69 8277 ..... 137  
 69 8281 ..... 137  
 69 8297 ..... 137  
 69 16002 ..... 138  
 69 16502 ..... 138  
 69 24206 6ML ..... 127  
 69 24213 13ML ..... 127  
 69 24236 36ML ..... 127  
 69 27106 6ML ..... 127  
 69 27113 13ML ..... 127  
 69 27136 36ML ..... 127  
 69 31310 ..... 128  
 69 31312 ..... 128

69 31319 ..... 129  
 69 31914 ..... 129  
 69 31919 ..... 129  
 69 32325 ..... 129  
 69 32327 ..... 129  
 69 32329 ..... 129  
 69 32507 ..... 128  
 69 32509 ..... 128  
 69 32927 ..... 129  
 69 32929 ..... 129  
 69 33102 2G X 2 TUBES WITH NOZZLES ..... 127  
 69 33106G 6G BRUSH APPLICATOR ..... 127  
 69 33120 20G ..... 127  
 69 33220 20G (WITHOUT BLISTER PACKAGING) ..... 127  
 69 33400 15G ..... 127  
 69 33701 ..... 130  
 69 37801 ..... 130  
 69 37901 ..... 130  
 69 37903 ..... 130  
 69 37906 ..... 130  
 69 37912 ..... 130  
 69 37990 ..... 131  
 69 38236 ..... 133  
 69 38237 ..... 131  
 69 38248 1 INCH ..... 133  
 69 38260 2 INCH ..... 133  
 69 38503 ..... 131  
 69 38553 ..... 131  
 69 38572 ..... 133  
 69 39036 ..... 131  
 69 39205 ..... 133  
 69 39206 ..... 133  
 69 40001 ..... 132  
 69 40002 ..... 132  
 69 40003 354ML ..... 132  
 69 40004 946ML ..... 132  
 69 40006 ..... 132  
 69 50099 ..... 134  
 69 50101 ..... 134  
 69 50112 ..... 134  
 69 50114 ..... 134  
 69 50132 ..... 134  
 69 50133 ..... 134  
 69 50139 ..... 135  
 69 50151 ..... 135  
 69 50165 ..... 135  
 69 50172 ..... 135  
 69 50176 ..... 135  
 69 50240H ..... 135  
 69 K3501 ..... 139  
 69 K5501 ..... 139  
 69 K5516 ..... 139  
 69 TKFLUID500 ..... 138  
 69 TKTEST ..... 138  
 70 955806 ..... 45  
 70 958905B ..... 51  
 70 88009000 ..... 55  
 70 AP9000 ..... 55  
 70 APFHRK ..... 48  
 70 ATB2 ..... 53  
 70 ATB2GB GLOSS BLACK ..... 53  
 70 ATB3USB ..... 53  
 70 FP6405 ..... 51  
 70 FP6421 ..... 53  
 70 FP6422 ..... 53  
 70 FP6425 ..... 55  
 70 FP6426 ..... 53  
 70 FP7320 ..... 49  
 70 FP8016 ..... 52  
 70 FP8018 ..... 46  
 70 FP8018K ..... 46  
 70 FP8020 ..... 55  
 70 FP8023 ..... 43  
 70 FP8061 ..... 49  
 70 FP8061K ..... 49  
 70 FP8072 ..... 50  
 70 FP8165 ..... 52  
 70 FP8166 ..... 54  
 70 FP8174 ..... 52  
 70 FP8357 ..... 50

70 FP8452	50
70 FP9008BN	55
70 FP9014	55
70 FP9016	53
70 FP9016GB GLOSS BLACK	53
70 FP9018	46
70 FP9026	54
70 FP9035	49
70 FP9042	44
70 FP9042M	44
70 FP9043	51
70 FP9046B1 BLACK	47
70 FP9046G1 GREY	47
70 FP9046K	47
70 FP9049	52
70 FP9049K	52
70 FP9050	50
70 FP9056 BLACK	47
70 FP9056G GREY	47
70 FP9056GK GREY	47
70 FP9056K BLACK	47
70 FP9066	50
70 FP9072	45
70 FP9090	43
70 FP9092	51
70 FP9102	43
70 FP9110	51
70 FP9134	43
70 FP9140	44
70 FP9144	45
70 FP9240	44
70 FP9350BK BLACK	48
70 FP9350GK GREY	48
70 FP9450BK BLACK	48
70 FP9450GK GREY	48
70 FP9750GK GUNMETAL GREY	44
70 FP9750SK SILVER	44
70 FP9888	54
70 FP9888K	54
70 FP953000	55
70 FP957325	49
70 FP958902	51
70 FP997505	50
70 WC62P	48
71 AFD2AUX	79
71 AP1761	85
71 APJVCPL	87
71 APMZAUX	82
71 APP8ALPH	86
71 APP8ALPV	86
71 APP8JVC3	86
71 APP8JVC5	86
71 APP8KE4	87
71 APP8KE5	87
71 APP8KE6	87
71 APP8PAN	88
71 APP8PIO5	88
71 APP8PIO8	88
71 APP8SP	89
71 APP8SP3	89
71 APP8SP4	89
71 APP9ALPH	86
71 APP9ALPV	86
71 APP9JVC3	87
71 APP9JVC5	87
71 APP9PIO5	88
71 APP9PIO8	88
71 APP9SP3	89
71 APP9SP4	89
71 APP019	78
71 APP021	78
71 APP022	78
71 APP051	79
71 APP053	79
71 APP055	79
71 APP056	79
71 APP062	80
71 APP063	80
71 APP064	80
71 APP070	81

71 APP071	81
71 APP072	82
71 APP076	81
71 APP077	81
71 APP085	82
71 APP086	82
71 APP087	82
71 APP090	84
71 APP091	84
71 APP0111	83
71 APP0113	83
71 APP0120	83
71 APP0121	83
71 APP0140	85
71 APP0141	85
71 APP7210	84
71 APP7220	84
71 APPIOPL	88
71 APS22	91
71 APS32	91
71 APS34	91
71 APS36	91
71 APS52	91
71 APS58	91
71 APSONYPL	89
71 APTOUSB1	90
71 APUNIDL2	90
71 APUNISW2	90
71 APUNISW5	90
71 APUNIUSB	90
71 APVIZ01	92
71 APVMT01	92
71 APVTY01	92
71 APVTY02	92
71 APVTY03	92
71 APVTY04	92
71 CHMB1C	83
71 CHMZ3C	82
71 CHSZ1C	84
71 CHTO2C	85
71 CHTO3C	85
71 CHVV3C	84
71 CHVVZC	80
72 ADM2R35A	100
72 AP939-12	99
72 AP940 2X40/0.12 - 100M	99
72 AP941 14G - 100M	99
72 AP942 12G - 100M	99
72 AP942-20 12G - 20M	99
72 AP951 16G - 100M	99
72 BSX204	99
72 BSX208	99
72 BSX408	99
72 BSX430B SMOKE GREY	99
72 BSX430R RED	99
72 BSX850B SMOKE GREY	99
72 BSX850R RED	99
72 BSX18100	99
72 MX12	100
72 MX020B BLUE	99
72 MX020C CLEAR	99
72 MX21	100
72 MX120	100
72 MX255	100
72 MX550	100
72 MX555	100
73 APOGRT	98
73 AP4GRT	98
73 AP406	96
73 AP410	96
73 AP452A	96
73 AP459 40AMP	96
73 AP460 50AMP	96
73 AP461 60AMP	96
73 AP462A	96
73 AP466 80AMP	96
73 AP467 100AMP	96
73 AP468 150AMP	96
73 AP469 200AMP	96
73 AP484	97

73 AP502	97
73 AP503	97
73 AP610	97
73 AP622	98
73 AP701	98
73 AP702	98
73 AP704	98
73 AP707	98
73 AP711	98
73 AP3042A	96
73 AP3044A	96
73 AP8286	97
73 AP8287	97
73 APRTK2	97
74 ADM95B	58
74 ADM105C	58
74 ADM200TC	58
74 ADMQC3U	58
74 AMPFMT35	58
74 APBT200	59
74 APBT210	59
74 CA900	58
74 FMT225	59
75 AP316	94
75 AP3062C	94
75 AP3081C	94
75 AP3161	94
75 AP3181	94
75 APMS400	94
75 APMS1500	94
75 APS331	94
75 APS353	94
75 DEE262018	57
75 PB6902	95
75 SA4BJM	101
75 SA360W	101
75 SA400B 3 INCH - BLACK	101
75 SA400W 3 INCH - WHITE	101
75 SA500B 4 INCH - BLACK	101
75 SA500W 4 INCH - WHITE	101
75 SA600WM	101
75 SA822M	101
75 SA1406 14GA - 6M	101
75 SA1430 14GA - 30M	101
75 SA1630 16GA - 30M	101
75 SA1806 18GA - 6M	101
75 SA1830 18GA - 30M	101
75 SB60A	95
75 SB69A	95
75 SB12100	95
75 VTVY96	95
76 DB477A	248
76 DB477E	248
76 DBH2EM	249
76 DBH03	248
76 DBH11R	248
76 DBH50RKT	249
76 G4KDVR20	242
76 G30CL	246
76 G30DL	246
76 G45CL	246
76 G55CL	247
76 GDVR250	242
76 GHDVR85W	242
76 GHDVR95W	243
76 GHW	247
76 GHWCUSB2	243
76 GRM430EM	243
76 GRV43KT	245
76 GRV43MKT	244
76 GRV50KT	245
76 GRV90MKT	244
76 GT14SD	247
76 GT16SD	247
76 GT50L	246
76 GT70SDTK	245
76 GT700SD	244
76 IVOLTMN	249
76 PLC3	247
76 PLC15	247

80 11HS8	13
80 12KMTAP	21
80 12KMTAP	371
80 12KMTED	21
80 12KMTED	371
80 12KMTES	21
80 12KMTES	371
80 41KM604W	21
80 41KM604W	371
80 41KMLC	20
80 41KMLC	371
80 41KMS674C	20
80 41KMS674C	370
80 41KMT674	20
80 41KMT674	370
80 41QSS674	14
80 42PXIBT1002	25
80 43CWRT102	10
80 43CWRT122	10
80 43L7QB82	12
80 44KKP212	12
80 44L7S154	10
80 44QSC674	14
80 45DL7R122	12
80 45KM102 2 OHM	11
80 45KM102 2 OHM	370
80 45KM104 4 OHM	11
80 45KM104 4 OHM	370
80 45KM654	21
80 45KM654	371
80 45KM654L	21
80 45KM654L	371
80 45KMA3004	24
80 45KMA3004	372
80 45KMA4506	24
80 45KMA4506	372
80 45KMA6001	24
80 45KMA6001	372
80 45KMG10C CHARCOAL	11
80 45KMG10W WHITE	11
80 45L7R122	10
80 45L7R152	10
80 46CSC44	18
80 46CSC54	18
80 46CSC464	18
80 46CSC654	18
80 46CSC684	19
80 46CSC6934	19
80 46CSS654	15
80 46CSS674	15
80 46CSS684	15
80 46CWTB82 2 OHM	12
80 46CWTB84 4 OHM	12
80 46CXA3604	23
80 46CXA4001	23
80 46CXA8001	23
80 46CXA12001	22
80 46CXA18001	22
80 46CXARC	23
80 46HS10	13
80 46KB6B BLACK	25
80 46KB6G GREY	25
80 46KMC3	25
80 46KMC3	370
80 46KMC4	25
80 46KMC4	370
80 46KMC5	25
80 46KMC5	370
80 46KST2504	16
80 46PK4	23
80 46TL7T102 10 INCH 500W	12
80 46TL7T122 12 INCH 600W	12
80 47KEY2004	22
80 47KEY5001	22
80 47KSC404	16
80 47KSC504	17
80 47KSC3504	16
80 47KSC4604	17
80 47KSC6504	17
80 47KSC6804	17



80 47KSC6904.....17  
 80 47KS6504.....15  
 80 47PSM34.....25  
 80 48CWR102 2 OHM.....11  
 80 48CWR104 4 OHM.....11  
 80 48CWR122 2 OHM.....11  
 80 48CWR124 4 OHM.....11  
 80 48CWR152.....11  
 80 48CWRT102.....11  
 80 48CWRT122.....11  
 80 48KMA3604.....24  
 80 48KMA3604.....372  
 80 48KMA6006.....24  
 80 48KMA6006.....372  
 80 48KMA8001.....24  
 80 48KMA8001.....372  
 80 48TCWRT82.....13  
 80 48TCWRT102.....13  
 80 48TCWRT122.....13  
 80 48TCWRT672.....13  
 80 48TRTP82.....13  
 80 48TRTP102.....13  
 80 48TRTP122.....13  
 80 48VCWR122.....12  
 81 CZ207AU.....26  
 81 CZ307AU.....26  
 81 FX688A.....26  
 81 FZ307AU.....26  
 81 IR700.....26  
 81 SE1625R.....27  
 81 SE6934R.....27  
 81 SH1624S.....27  
 81 SH1634R.....27  
 81 VT1020A.....26  
 81 XC2110.....27  
 81 XC2410.....27  
 82 AP1.....37  
 82 AP65.....32  
 82 APBX8DS.....33  
 82 APBX8R.....33  
 82 APBX10A2.....32  
 82 APBX10DS.....32  
 82 APG4 4 INCH.....37  
 82 APG5 5 INCH.....37  
 82 APK130.....38  
 82 APK165.....38  
 82 APK165P.....39  
 82 APK1652O.....39  
 82 APS8D.....34  
 82 APS8R.....34  
 82 APS10D.....33  
 82 APS10S4S.....34  
 82 APX4.....36  
 82 APX5.....36  
 82 APX6.5.....36  
 82 AVK6.....37  
 82 BITTEN.....41  
 82 ELAP4.....35  
 82 ELAP5.....35  
 82 ELAP8.....35  
 82 SR1500.....40  
 82 SR4300.....40  
 82 SR4500.....40  
 82 SR5600.....41  
 83 CK165.....29  
 83 CX100.....29  
 83 CX165.....29  
 83 DBX303.....28  
 83 DCX160.3.....30  
 83 DCX1003.....30  
 83 DCX1303.....30  
 83 DCX4603.....30  
 83 DCX6903.....30  
 83 DS253.....28  
 83 DS303.....28  
 83 DSK160.3.....30  
 83 ESF205.....28  
 83 HCP5MD.....31  
 83 HEX6.5MC BLACK.....30  
 83 HEX6.5MW WHITE.....30

83 HMR10.....28  
 83 HMR20.....28  
 83 MLK16503.....31  
 83 MPK165P3.....31  
 83 MPK1653.....31  
 83 MPX1653.....31  
 90 12204.....235  
 90 12206.....235  
 90 12208.....235  
 90 12264.....235  
 90 194225 SILVER.....238  
 90 194245 BLUE.....238  
 90 194255 RED.....238  
 90 195000.....238  
 90 AC56129 RED.....224  
 90 AC56130 BLUE.....224  
 90 FP90G.....235  
 90 LP250 250ML.....237  
 90 LP500 500ML.....237  
 90 MN4203.....236  
 90 PAC.....235  
 90 PF.....235  
 90 PH.....235  
 90 TG1.....236  
 90 TG4A.....236  
 90 TG8.....236  
 90 TG9.....236  
 90 TG14.....238  
 90 TG19.....236  
 90 TG24.....236  
 90 TG31.....237  
 90 TG32.....237  
 90 TG33.....237  
 90 TG34.....237  
 90 TG35.....236  
 90 TG36.....237  
 90 TWB.....239  
 91 PXP100 BLADE FUSES.....147  
 91 PXP101 MINI BLADE FUSES.....147  
 91 PXP103.....147  
 91 PXP105.....147  
 91 PXP120.....147  
 91 PXP123.....147  
 91 PXP130.....147  
 91 PXP131.....147  
 91 PXP132.....147  
 91 PXP200.....147  
 93 MAG15.....239  
 93 STE12 1/2IN.....239  
 93 STE15 12 X 1.5MM.....239  
 93 STE125 12 X 1.25MM.....239  
 94 A12-4 1/2 IN PK4.....239  
 94 A15-4 12 X 1.5MM PK4.....239  
 94 A125-4 12 X 1.25MM PK4.....239  
 94 A716-4 7/16 IN PK4.....239  
 94 B12-4 1/2 IN PK4.....239  
 94 B15-4 12 X 1.5MM PK4.....239  
 94 B125-4 12 X 1.25MM PK4.....239  
 94 B716-4 7/16 IN PK4.....239  
 94 S1520BL BLACK.....238  
 94 S1520CH CHROME.....238  
 94 S12520BL BLACK.....238  
 94 S12520CH CHROME.....238  
 95 MW.....239  
 5802M-30BK BLACK.....368  
 5802M-30RD RED.....368  
 5808M-30BK BLACK.....368  
 5808M-30RD RED.....368  
 5812M-30BE BLUE.....368  
 5812M-30BK BLACK.....368  
 5812M-30BN BROWN.....368  
 5812M-30GN GREEN.....368  
 5812M-30RD RED.....368  
 5812M-30WE WHITE.....368  
 5812M-30YW YELLOW.....368  
 5814M-30BK BLACK.....368  
 5814M-30RD RED.....368  
 5816M-30BK BLACK.....368  
 5816M-30RD RED.....368  
 5824M-30TW.....368

5826M-30TW.....368  
 5834M-30WYB.....368  
 5852M-30ETC.....368  
 5853M-30TC.....368  
 54444BL.....369  
 54445BL.....369  
 54446BL.....369  
 54450BL.....369  
 56503BL.....369  
 56822.....369  
 56824.....369  
 56832.....369  
 56834.....369  
 56838.....369  
 56922.....369  
 56924.....369  
 60016BL.....363  
 60031BL.....363  
 60062BL.....363  
 61036 100A.....363  
 61036BL 100A BLISTER PACK.....363  
 61037 RED.....363  
 61038.....363  
 61038BL BLISTER PACK.....363  
 61039.....363  
 61040 YELLOW.....363  
 61043 200A.....363  
 61043BL 200A BLISTER PACK.....363  
 61044BL.....363  
 61045.....363  
 61045BL BLISTER PACK.....363  
 61078BL.....364  
 61079.....364  
 61082BL.....364  
 61084BL.....364  
 61090.....364  
 61092BL.....364  
 63158BL RED.....366  
 63159BL BLUE.....366  
 63164BL RED.....366  
 63165BL BLUE.....366  
 63166BL RED.....366  
 63167BL BLUE.....366  
 63168BL RED.....366  
 63169BL BLUE.....366  
 63170BL RED.....366  
 63171BL BLUE.....366  
 63172BL RED.....366  
 63173BL BLUE.....366  
 63178BL.....366  
 63190.....365  
 63191.....365  
 63193.....365  
 63194.....365  
 63196.....365  
 63198BL.....365  
 63218BL.....366  
 63224BL.....367  
 63232BL.....367  
 63236BL.....367  
 63238BL.....367  
 63254BL.....366  
 63255BL.....366  
 63256BL.....367  
 63257BL.....367  
 63258BL.....367  
 64008.....364  
 64012.....364  
 71000.....357  
 71001.....357  
 71007.....357  
 71009.....357  
 72271W.....352  
 72272W.....352  
 72274W.....352  
 72282W.....352  
 72412W.....354  
 72443/10 BLACK - PACK OF 10.....354  
 72443 BLACK.....354  
 72443W/10 WHITE - PACK OF 10.....354

72443W WHITE.....354  
 72446W.....354  
 72449W.....354  
 72451W.....354  
 72467W.....353  
 72730W.....353  
 72733W.....353  
 72736W.....353  
 72802 BLACK.....356  
 72803 WHITE.....356  
 72806 12V BLACK.....356  
 72808 12V WHITE.....356  
 72809 24V WHITE.....356  
 74138.....356  
 74139.....356  
 74140.....356  
 81025W.....362  
 81025WBL BLISTER PACK.....362  
 81026WBL.....362  
 81134WBL.....362  
 81154WBL.....362  
 81160WBL.....362  
 81168WBL.....362  
 82103BL.....362  
 87501WR-BKBL 75MM - BLACK HOUSING.....358  
 87501WRBL 75MM - WHITE HOUSING.....358  
 87503WR-BKBL 150MM - BLACK HOUSING.....358  
 87503WRBL 150MM - WHITE HOUSING.....358  
 87538WBBL WHITE/BLUE L.E.D.....354  
 87538WRBL WHITE/RED L.E.D.....354  
 87605.....358  
 87608BL COOL WHITE.....358  
 87609BL BLUE.....358  
 87610BL RED.....358  
 87800BL 30CM - BLISTER PACK.....355  
 87800WBL 30CM - BLISTER PACK.....355  
 87801/10 60CM - BULK PACK OF 10.....355  
 87801BL 60CM - BLISTER PACK.....355  
 87801WBL 60CM - BLISTER PACK.....355  
 87802/10 1.2M - BULK PACK OF 10.....355  
 87802BL 1.2M - BLISTER PACK.....355  
 87802WBL 1.2M - BLISTER PACK.....355  
 87804 5M REEL.....355  
 87804W 5M REEL.....355  
 87805BL 30CM - BLISTER PACK.....355  
 87806/10 60CM - BULK PACK OF 10.....355  
 87806BL 60CM - BLISTER PACK.....355  
 87807BL 1.2M - BLISTER PACK.....355  
 87809 5M REEL.....355  
 87810.....355  
 87810B BLUE.....355  
 87810R RED.....355  
 91338-6.....361  
 93732-9 REPLACEMENT LAMP.....361  
 93736-9 REPLACEMENT LAMP WITH LICENCE PLATE.....361  
 93750BL2-NZ BLISTER PACK.....361  
 93750NZ BOXED.....361  
 93790.....361  
 93792.....361  
 94142TP.....361  
 99010BL WHITE WITH COLOURED LENSES.....359  
 99012BL WHITE WITH CLEAR LENSES.....359  
 99014BL BLACK WITH COLOURED LENSES.....359  
 99016BL BLACK WITH CLEAR LENSES.....359  
 99080BL.....359  
 99082BL.....359  
 99090BL.....359  
 99092BL.....359  
 99104BL.....360  
 99106BL.....360  
 99120BL WHITE.....358  
 99122BL BLACK.....358  
 99140BL.....360  
 99142BL.....360  
 99144BL.....360  
 99146BL.....360  
 99200BL.....358  
 99202BL BLUE.....358  
 99204BL WHITE.....358  
 BC50MM.....267

BC200E 200AMP ..... 267  
 BC400E 400AMP ..... 267  
 BR9012 ..... 261  
 BR9022 ..... 261  
 BR9032 ..... 261  
 BR9095 ..... 261  
 BR9112 ..... 262  
 BR9122 ..... 262  
 BR9142 ..... 262  
 BR9190 ..... 261  
 BR9222 ..... 262  
 BR9290 ..... 261  
 EVAPT1T2 ..... 293  
 EVAPT2T1 ..... 293  
 EVBR EVA CASE TO SUIT ELECTRIC VEHICLE CABLES ..... 291  
 EVBR EVA CASE TO SUIT ELECTRIC VEHICLE CABLES ..... 292  
 EVBS EVA CASE TO SUIT SINGLE PHASE ELECTRIC VEHICLE CHARGER ..... 290  
 EVC2KW ..... 290  
 EVCBT2T1 ..... 292  
 EVCBT2T2 1 PHASE ..... 291  
 EVCBT2T2-3P 3 PHASE ..... 291  
 EVEHT1 ..... 294  
 EVEHT2 ..... 294  
 EVICT2 ..... 294  
 EVOCT1 ..... 294  
 EVOCT2 ..... 294  
 EVWHT1 ..... 294  
 EVWHT2 ..... 294  
 KT350C ..... 270  
 KT703 ..... 281  
 KT704 ..... 281  
 KT744 ..... 280  
 KT744C ..... 281  
 KT1000 ..... 270  
 KT10025 ..... 268  
 KT10025 ..... 270  
 KT10025NT ..... 268  
 KT15235 ..... 268  
 KT15235 ..... 270  
 KT15235MC ..... 271  
 KT15235NT ..... 268  
 KT15235R ..... 270  
 KT20025 ..... 268  
 KT20035 ..... 268  
 KT20080 ..... 269  
 KT20247 ..... 268  
 KT20247 ..... 270  
 KT20247MC ..... 271  
 KT20247NT ..... 268  
 KT20247R ..... 270  
 KT21500S ..... 273  
 KT21501S ..... 273  
 KT21502S ..... 273  
 KT21503S ..... 273  
 KT21510S ..... 273  
 KT21511S ..... 273  
 KT21512S ..... 273  
 KT25036 ..... 268  
 KT25048 ..... 268  
 KT25048NT ..... 268  
 KT29236 ..... 268  
 KT30080 ..... 269  
 KT30148 ..... 268  
 KT30148 ..... 270  
 KT30148MC ..... 271  
 KT30148MX ..... 271  
 KT30148NT ..... 268  
 KT30148R ..... 270  
 KT32001 ..... 271  
 KT32002 ..... 271  
 KT32003 ..... 271  
 KT32053 ..... 284  
 KT32053 ..... 285  
 KT32054 ..... 284  
 KT32055 ..... 284  
 KT38275 ..... 269  
 KT38275NT ..... 269  
 KT38348 ..... 268  
 KT38348NT ..... 268  
 KT41000 ..... 271

KT41001 ..... 271  
 KT41002 ..... 271  
 KT41003 ..... 271  
 KT41010 ..... 271  
 KT41015 ..... 271  
 KT41020 ..... 271  
 KT41050 ..... 271  
 KT41055 ..... 271  
 KT41060 ..... 271  
 KT43090 ..... 269  
 KT43248 ..... 268  
 KT53390 ..... 269  
 KT55013 ..... 269  
 KT70030S ..... 347  
 KT70040S 2 TERMINALS, 1PK ..... 278  
 KT70551 ..... 279  
 KT70553 ..... 278  
 KT70554 ..... 278  
 KT70555 ..... 278  
 KT70558 ..... 279  
 KT70561 ..... 279  
 KT70565 ..... 279  
 KT70566 ..... 349  
 KT70567 ..... 349  
 KT70568 ..... 349  
 KT70571 ..... 280  
 KT70572 ..... 280  
 KT70573 ..... 349  
 KT70574 ..... 349  
 KT70600 ..... 276  
 KT70601 ..... 275  
 KT70602 ..... 277  
 KT70710 ..... 339  
 KT70713 ..... 334  
 KT70714 ..... 329  
 KT70715 ..... 329  
 KT70716 ..... 330  
 KT70717 ..... 330  
 KT70721 ..... 333  
 KT70723 ..... 335  
 KT70727 ..... 338  
 KT70728 ..... 331  
 KT70729 ..... 331  
 KT70731 ..... 340  
 KT70733 ..... 336  
 KT70743 ..... 337  
 KT70747 ..... 341  
 KT70748 ..... 341  
 KT70749 ..... 341  
 KT70752 ..... 274  
 KT70753 ..... 341  
 KT70755 ..... 342  
 KT70756 ..... 343  
 KT70757 ..... 345  
 KT70762 ..... 344  
 KT70770 ..... 348  
 KT70771 ..... 348  
 KT70772 ..... 348  
 KT70773 ..... 348  
 KT70774 ..... 348  
 KT70776 ..... 348  
 KT70777 ..... 332  
 KT70780 ..... 346  
 KT70781 ..... 346  
 KT70783 ..... 346  
 KT71203 ..... 282  
 KT71204 ..... 282  
 KT72301 450A ..... 283  
 KT72304 750A ..... 283  
 KT76290 ..... 269  
 KT83090 ..... 269  
 KT103013 ..... 269  
 KT1002525 ..... 268  
 KT1523525 ..... 268  
 KT2024725 ..... 268  
 KT3014825 ..... 268  
 KT3827525 ..... 269  
 KT3834825 ..... 268  
 KT5339025 ..... 269  
 KTAMALG-5 ..... 272

KTDUCT ..... 272  
 KTDUCTB ..... 272  
 KTGAF ..... 272  
 KTGMC0603S ..... 273  
 KTGMC0705S ..... 273  
 KTGMC1006S ..... 273  
 KTGMC1410S ..... 273  
 KTGMC2015S ..... 273  
 KTGMC2518S ..... 273  
 KTHDC50BE ..... 349  
 KTHDC50RD ..... 349  
 KTHDC502S 4 TERMINALS, 2PK ..... 278  
 KTHDCTG/9 ..... 284  
 KTHDCTG/M ..... 284  
 KTHDCTG/P ..... 284  
 KTMH15535 ..... 269  
 KTMH20546 ..... 269  
 KTNCG12 ..... 273  
 KTNCG16 ..... 273  
 KTNCG20 ..... 273  
 KTNCG25 ..... 273  
 KTNCG32 ..... 273  
 KTNCG40 ..... 273  
 KTNCG50 ..... 273  
 KTNCG63 ..... 273  
 KTPT155 ..... 269  
 KTPT202 ..... 269  
 KTRT13076 ..... 269  
 KTRT14035 ..... 269  
 KTRT20247 ..... 269  
 KTRT30048 ..... 269  
 KTSOLR1.6 ..... 272  
 KTSOLR2.3 ..... 272  
 KTSOLR3.2 ..... 272  
 KTV20019/100 ..... 271  
 KTV30025/75 ..... 271  
 MC4-2 ..... 327  
 MC4-F ..... 327  
 MC4-M ..... 327  
 MC4-YN ..... 327  
 MC4-YP ..... 327  
 MX100BL2 ..... 266  
 MX102BL2 ..... 266  
 MX150BL2 ..... 266  
 MX152BL2 ..... 266  
 MX160 ..... 266  
 MX583BL ..... 267  
 MX900 ..... 267  
 MX902 ..... 267  
 MX1000 ..... 266  
 SA-50A2A ..... 326  
 SA-50A12VI ..... 326  
 SA-50A12VO ..... 326  
 SA-50AHDC ..... 326  
 SA-50AHDRT ..... 326  
 SA-50AMC4 ..... 326  
 SA-50AMC4L ..... 326  
 SA-50AMC4RT ..... 327  
 SA-MRL ..... 327  
 SA-MRS ..... 327  
 SC008 ..... 314  
 SC015 ..... 315  
 SC110 ..... 316  
 SC220 ..... 317  
 SC245 ..... 318  
 SC260 ..... 319  
 SC320D ..... 320  
 SC330D ..... 321  
 SC420 ..... 322  
 SC440 ..... 323  
 SC520 ..... 324  
 SC540 ..... 325  
 SPA5 5W ..... 301  
 SPA100 1.5W ..... 300  
 SPF100 100W ..... 308  
 SPF180 180W ..... 309  
 SPM25 25W ..... 304  
 SPM50 50W ..... 304  
 SPM80 80W ..... 305  
 SPM95 95W ..... 305

SPM120K 120W ..... 302  
 SPM155-MC4 155W ..... 306  
 SPM170-MC4 170W ..... 306  
 SPM180K 180W ..... 303  
 SPM200-BKT ..... 307  
 SPM200-MC4 200W ..... 307  
 TBS700 ..... 361  
 TW-PPCAP ..... 361

## A-Z

Accessory socket.....	113, 362
AC Pro.....	267
Adhesive.....	134-137
Aerial.....	60-66
aerial adaptors.....	67-73
aerial extension leads.....	67
band expanders.....	69
CB aerials.....	74-77
FM boosters.....	69
Aerosol trigger handle.....	162
Aerpro.....	112-114
aerial leads & adaptors.....	67-73
aerials.....	62-66
audio accessories.....	96-98
band expander.....	69
cable.....	99
CB aerials & brackets.....	74-77
chargers, cables & accessories.....	58-59, 112-113
facias & pockets.....	43-55
FM transmitters.....	58-59
harnesses.....	78-92
home audio.....	101
phone chargers.....	112-113
phone holders.....	112, 114
RCA leads.....	100
speaker spacers.....	94
subwoofer & speaker boxes.....	95
Air compressor, mini.....	235
Air conditioning cleaner.....	111
Air filter.....	144
Air freshener.....	106-111
Air pump.....	235
Air scoop vent.....	226
All Blacks	
air freshener.....	111
All Blacks range.....	6
decal stickers.....	222
mats.....	175, 177
number plate frame.....	229
seat belt pad.....	185
seat covers.....	168
steering wheel cover.....	184
sunshade.....	121
All weather mats.....	176-179
Aluminium mesh.....	227
Amalgamating tape.....	272
Amplifier	
bluetooth.....	25
car.....	22-25, 27, 31, 40-41
marine.....	24, 372
motorcycle/ATV.....	25
wiring kits.....	99
Amplifier wiring kit.....	23
Anchor lamp.....	360
Antech.....	60-69
Anti-fog.....	151
Anti-static strap.....	232
Assortment pack	
blade fuses.....	147
electrical terminals.....	147
heat shrink tubes.....	147
O-rings.....	147
plumbing washers.....	147
rubber grommets.....	147
split pins.....	147
washers.....	147
Audio fuses	
AGU fuse holders.....	96
AGU fuses.....	96
ANL fuse holders.....	96
ANL fuses.....	96
Audio harness.....	78-90
Audison.....	32-41
Aunger.....	214
Badge.....	221
Band expander.....	69
Bass remote controller.....	23

Battery box.....	282
Battery master switch.....	363-364
Battery terminals.....	97
Big Red.....	261-263
Big Wipes.....	126
Black Magic.....	158
Black trim restorer.....	158
Blade fuses.....	147
Blue Magic.....	159
Bluetooth amplifier.....	25
Boat lighting.....	352-361
Boat wash brush.....	155, 160
Bonnet release cable.....	146
Booster cable.....	267, 283
Boot organiser.....	123
Bumper marker.....	231
Bungee cords.....	231
Butt splice joiner.....	273
Cable.....	368
Cable crimper.....	284
Cable gland.....	273
Cable lock.....	122
Cable tie gun.....	284
Cable ties.....	268-271, 369
Car audio	
aerials.....	60-66
amplifiers.....	22-23, 27, 31, 40-41
amplifier wiring kit.....	23
audio distribution blocks.....	96
audio line convertors.....	96
audio removal tool.....	97
bass remote controller.....	23
battery terminals.....	97
cable.....	99
cassette adaptor.....	58
circuit breakers.....	97
facias & pockets.....	43-55
fuses.....	96
harnesses.....	78-90
headphones.....	26
headunits.....	26
monitors.....	26
radio removal keys.....	48
speakers.....	14-19, 27, 29-31, 35-39
speaker spacers.....	94
steering wheel control interface.....	90
subwoofer boxes.....	95
subwoofer enclosures.....	12-13, 28, 32-33
subwoofers.....	10-11, 28, 32-34
terminals.....	98
voltage reducer.....	97
Carbon fibre wrap.....	115, 223
Carburetor cleaner.....	143
Car cover.....	229
Carpet mats.....	174-175
Car wash.....	153, 157
Car wash brush.....	155, 160
Car wash mop.....	154
Car wash sponge.....	154, 160
Cassette adaptor.....	58
Caterpillar	
Caterpillar range.....	7
mats.....	177
seat covers.....	168
steering wheel cover.....	184
sunshade.....	121
CB aerial.....	74-77
CB radio.....	248-249
Ceramic detailer.....	153
Chamois.....	154, 161
Charging cable, USB.....	58
Charging socket, USB.....	58, 113
Choke cable.....	146
Cigarette lighter kit.....	233
Circuit breaker.....	97
Clarion.....	26-27
Cloth tape.....	228
Combination lock.....	122
Combustion leak detector.....	138
Coolant leak repair.....	139

Cooler bag.....	123
Crimping tool.....	284
Crystal.....	248-249
Dash cam.....	242-243
DC power link.....	275-277
Decal.....	222-223
Deck lamp.....	354
Degreaser.....	157
De-icer.....	158
Dirty Steve.....	156-157
Distilled water.....	285
Docking lamp.....	353
Dock light.....	358
Door protectors.....	233
Double sided tape.....	228
Dr Air.....	236-238
Dr Artex.....	57
Dri Lube stick.....	143
Drink holder.....	123
Driving light.....	261
Drying towel.....	154, 161
D-shackle.....	231
Duct tape.....	228, 272
Electrical connector.....	278-280
Electrical terminal.....	147
Emergency breakdown kit.....	232
Engine additive.....	143
Engine salt flush.....	157
Epoxy.....	132, 134-138
EV charging adaptor.....	293
EV charging cable.....	291
EV emergency charger.....	290
Exelwipe.....	215-217
Exhaust repair.....	130-131, 133
Extendable wash brush.....	155, 160
Exterior wrap.....	223
External battery.....	249
Facias & pockets.....	43-55
Audi.....	43
BMW.....	43
Ford.....	44-45
Holden.....	46-49
Mercedes.....	51
Mitsubishi.....	51
Nissan.....	51
Subaru.....	51
Suzuki.....	52
Toyota.....	53-54
Universal.....	55
Volkswagen.....	54
Fan, oscillating.....	123
Fiberglass repair.....	133
Filler.....	132
Film wrap.....	223
FM booster.....	69
FM transmitter.....	58-59
Foaming applicator gun.....	157
Foaming degreaser.....	157
Foaming wash.....	157
Foot pump.....	235
Fork terminals.....	98
Fuel cap.....	232
Fuel transfer pump.....	219
Fuel treatment.....	140-142
Funnel.....	218
Fuse.....	96, 147
Fuse box.....	369
Gaffer tape.....	272
Gasket repair.....	139
Gator.....	242-247
Gauge.....	117
Gear boot.....	119
Gear knob.....	118-119
Glass cleaner.....	151-153
Grommets.....	147, 273
Gumout.....	140-143
Hand cleaner.....	126
Handheld spot light.....	357
Hand pump.....	235
Handsfree kit.....	59

Harness.....	78-90
Head-check leak detector.....	138
Headlight restorer.....	152-153
Headphones.....	26
Headunit.....	26
Heat repair paste.....	130
Heat shrink tubes.....	147
Hertz.....	28-31
Hood pin kit.....	227
Hot Wheels	
air freshener.....	109
Hot Wheels range.....	7
Household speakers.....	25
Ice scraper.....	160
Ignition switch.....	364
Inspection camera.....	146
Interior light.....	358
Interior trim kit.....	115
Interior wrap.....	115, 223
J-B Weld.....	127-137
Jelly Jets.....	106-107
Jiggle siphon.....	219
Jumbo sponge.....	154
Jumper leads.....	267, 283
Kenco.....	160-161
Key remote	
Audi.....	187
BMW.....	187
Chrysler.....	188
Ford.....	189-191
Garage door.....	212-213
Holden.....	192-195
Honda.....	196
Hyundai.....	197-198
Jeep.....	188, 199
Kia.....	199
Land Rover.....	199
Lexus.....	199
Mazda.....	200-201
Mercedes.....	201
Mitsubishi.....	202-203
Nissan.....	204-205
Subaru.....	206
Suzuki.....	207
Toyota.....	207-212
Volkswagen.....	212
Kicker.....	10-25, 93, 370-373
K-Seal.....	139
KT	
battery box.....	282
cable joiners.....	273
cable ties.....	268-271
cable tool.....	284
DC power link.....	275-277
distilled water.....	285
electrical connector accessories.....	278-280
grommets & glands.....	273
jumper leads.....	283
power meter.....	274
solar charge controllers.....	342-346
solar leads & connectors.....	348-349
solar panel mounts.....	341
solar panels.....	329-340
solar voltmeter.....	347
solder.....	272
split looms.....	271
tape.....	272
trailer plugs.....	280-281
Leaf air freshener.....	108
Leather repair.....	127, 163
LED beacon.....	266
LED lighting kit.....	252-259
LED switch.....	366-367
LED tape lighting.....	355
Lens repair tape.....	228
Licensed products	
All Blacks.....	6
Caterpillar.....	6
Hot Wheels.....	7
R.M. Williams.....	6

Light bar ..... 262, 352-353  
 Liquid tape ..... 163  
 Little Joe ..... 110  
 Lock nuts ..... 238  
 L Plates ..... 123  
 Magnetic phone holder ..... 114  
 Mag wheel brush ..... 155, 160  
 Mag wheel nut washer ..... 239  
 Map keys & remotes ..... 187-213  
 Marine audio  
   amplifiers ..... 24, 372  
   enclosures ..... 20-21, 370-371  
   LED lighting remote ..... 20, 371  
   media receivers ..... 25, 28, 370  
   speakers ..... 21, 370-371  
   subwoofers ..... 11, 370  
 Marine cable ..... 368  
 Marine engine flush applicator ..... 157  
 Marine switch ..... 363-367  
 Marker lamp ..... 267, 361  
 Master battery switch ..... 363-364  
 Mast lamp ..... 360  
 Mats ..... 174-179  
 Maxilite ..... 266-267  
 MC4 connector ..... 326-327, 348  
 Media receiver ..... 25, 28, 370  
 Mesh ..... 227  
 Metal polish ..... 159  
 Michelin ..... 111, 158-159, 235-236  
 Microfibre towel ..... 161  
 Mirror ..... 230  
 Mirror weld ..... 130  
 Monitor ..... 26  
 Motorcycle windscreen rain repellent ..... 151  
 Mudflaps ..... 233  
 Muffler repair ..... 130, 131, 133  
 Narva ..... 264-265, 352-369  
 Navigation lights ..... 359  
 Number plate frames ..... 229  
 Oil breather filter ..... 144  
 Oil catch tank ..... 146  
 Oil drain pan ..... 219  
 Oil filter wrench ..... 146  
 Oil pressure tube kit ..... 117  
 O-rings ..... 147  
 Parts cleaner ..... 142  
 Patch repair ..... 131, 133  
 Pedal pads ..... 116  
 Phone charger ..... 112-113  
 Phone holder ..... 112, 114  
 Pinstripe ..... 220  
 Plastic surface rain repellent ..... 151  
 Plasti Dip ..... 162-163  
 Pod air filter ..... 144  
 Pod air filter adaptor ..... 145  
 Polishing cloth ..... 161  
 Portable battery box ..... 282  
 Power cable, audio ..... 99  
 Power meter, electrical ..... 274  
 Projecta  
   EV charging adaptor ..... 293  
   EV charging cable ..... 291-292  
   EV charging cable wall hooks ..... 294  
   EV emergency charger ..... 290  
   solar leads & connectors ..... 326-327  
   solar panel controllers ..... 312-325  
   solar panel mounting rails ..... 327  
   solar panels ..... 300-309  
 Pumps, air ..... 235  
 Puncture repair ..... 237  
 Quicksteel ..... 138  
 Radiator overflow ..... 146  
 Radiator repair kit ..... 127  
 Radio earmuffs ..... 101  
 Radio removal keys ..... 48  
 Rain repellent ..... 151  
 Rain-X ..... 151-155  
 Ratchet tie downs ..... 231  
 RCA adaptor ..... 98  
 RCA lead ..... 100

Reflective tape ..... 220  
 Registration holder ..... 230  
 Repair kits  
   epoxy/fiberglass patch ..... 133  
   exhaust repair ..... 131  
   headlight restoration ..... 152  
   leather repair ..... 127  
   puncture repair ..... 237  
   radiator repair ..... 127  
   tank repair ..... 127  
   tyre repair ..... 237  
   windshield repair ..... 127, 152  
 Reverse camera ..... 243-247  
 Reverse camera retention lead ..... 92  
 Ring terminals ..... 97-98  
 R.M. Williams  
   decals ..... 222  
   mats ..... 175, 177  
   R.M. Williams range ..... 6  
   seat covers ..... 169-170  
   steering wheel cover ..... 184  
   sunshade ..... 121  
 Rocker switch ..... 366-367  
 Rubber coating ..... 162-163  
 Rubber grommets ..... 147, 273  
 Rust protector ..... 156  
 RV wash brush ..... 155, 160  
 Salt remover ..... 157  
 Scene lamp ..... 353  
 Sealing tape ..... 272  
 Search lamp ..... 356  
 Seat belt pads ..... 185  
 Seat covers ..... 166-173  
 Seat protector ..... 123  
 Security lock ..... 122  
 Shower door cleaner ..... 153  
 Signal processor ..... 41  
 Silicone sealant ..... 128-129  
 Siphon pump ..... 219  
 Slick 50 ..... 143  
 Solar leads & connectors ..... 326-327, 348-349  
 Solar panel controller ..... 312-325, 342-346  
 Solar panel mount ..... 327, 341  
 Solar panels ..... 300-309, 329-340  
 Solder ..... 233, 272  
 Solder joiner ..... 273  
 Sound proofing ..... 56-57  
 Spade terminals ..... 98  
 Speaker adaptor lead ..... 91  
 Speakers  
   banana plugs ..... 101  
   car speakers ..... 14-19, 27, 29-31, 35-39  
   grilles ..... 37, 95  
   household speakers ..... 25, 101  
   marine speakers ..... 20-21, 371  
   motorcycle/ATV speakers ..... 25  
   spacers ..... 94  
   speaker adaptor leads ..... 91  
   speaker boxes ..... 95  
   speaker cable ..... 99, 101  
   wall plates ..... 101  
 Sphere ..... 111  
 Split looms ..... 271  
 Split pins ..... 147  
 Spoiler kit ..... 225  
 Spoke wheel brush ..... 155, 160  
 Sponge ..... 154, 160  
 Spot light ..... 357  
 Squeegee ..... 154  
 Stainless steel cable ties ..... 369  
 Standartplast ..... 56-57  
 Static mixer ..... 134  
 Steering wheel control interface ..... 90  
 Steering wheel cover ..... 184  
 Steering wheel lock ..... 122  
 Steering wheel spinner ..... 123  
 Stern lamp ..... 358  
 Stickers ..... 222  
 Strip lamp ..... 354  
 Subwoofer ..... 10-11, 28, 32-34

bass remote controller ..... 23  
 subwoofer boxes ..... 95  
 Subwoofer enclosures ..... 12-13, 28, 32-33  
 Sunshade ..... 120-121  
 Super glue ..... 127  
 Switch ..... 363-367, 366-367  
 Switch panel ..... 365  
 Tank repair kit ..... 127  
 Tape ..... 272  
 Tap washers ..... 147  
 Telescopic wash brush ..... 155, 160  
 Thinkware ..... 249  
 Threadlocker ..... 127  
 Tie Down ..... 231  
 Tow ball cover ..... 231  
 Tower speakers ..... 21-22, 370-371  
 Tow rope ..... 232  
 Tradies seat covers ..... 172  
 Trailer breakaway kit ..... 361  
 Trailer lights ..... 266  
 Trailer lock ..... 231  
 Trailer plug ..... 280-281  
 Trailers lights ..... 361  
 Trigger cable ..... 99  
 Truck wash brush ..... 155, 160  
 Type S  
   interior trim ..... 115  
   LED lighting ..... 252-258  
   spoiler kits ..... 225  
   wheel trim ..... 224  
 Tyre cover ..... 229  
 Tyre gauge ..... 236  
 Tyre repair ..... 237  
 Tyre shine ..... 158-159  
 Tyre valve tool ..... 236  
 UHF radio ..... 248-249  
 Underwater light ..... 358  
 USB lead ..... 90  
 USB socket ..... 113, 362  
 Valve caps ..... 238  
 Valve cores ..... 236  
 Valve grinder paste ..... 130  
 Vinyl repair ..... 163  
 Vinyl revitaliser ..... 156  
 Vinyl wrap ..... 223  
 Voltage relay ..... 364  
 Washers ..... 147  
 Wash mitt ..... 154  
 Water repellent ..... 151  
 Weather strip tape ..... 228  
 Wheel brace ..... 239  
 Wheel brush ..... 155, 160  
 Wheel clamp ..... 232  
 Wheel cleaner ..... 158-159  
 Wheel nuts ..... 239  
 Wheel rim accent trim ..... 224  
 Wildcat  
   air freshener ..... 108  
   air pump ..... 235  
   air scoop ..... 226  
   assortment packs ..... 147  
   badge ..... 221  
   breakdown kit ..... 232  
   decal sheet ..... 223  
   fuel tool ..... 219  
   funnel ..... 218  
   gauges ..... 117  
   gear knob ..... 118-119  
   hood pin ..... 227  
   lock nuts ..... 238  
   mats ..... 174-179  
   mesh ..... 227  
   mirror ..... 230  
   number plate frame ..... 229  
   oil pans ..... 219  
   parts & accessories ..... 146  
   pedal pads ..... 116  
   pinstripe ..... 220  
   pod filter ..... 144-145  
   seat belt pads ..... 185

seat covers ..... 166-168, 174-176  
 siphon ..... 219  
 steering wheel cover ..... 184  
 steering wheel lock ..... 122  
 sunshade ..... 120  
 tape ..... 228  
 tow rope ..... 232  
 trailer & towing accessories ..... 231  
 tyre cover ..... 229  
 valve caps ..... 238  
 vehicle interior accessories ..... 123  
 wheel brace ..... 239  
 wheel clamp ..... 232  
 wheel nuts ..... 239  
 window tint ..... 183  
 wiper refills & blades ..... 215  
 wrap ..... 223  
 Window cleaner ..... 154  
 Window tint ..... 183  
 Windscreen rain repellent ..... 151  
 Windscreen washer additive ..... 153, 159  
 Windshield repair ..... 152  
 Windshield repair kit ..... 127  
 Wiper blades ..... 215-217  
 Wiper refills ..... 214-215  
 WOF holder ..... 230  
 Wildcat ..... 230  
 Wood repair putty ..... 132  
 Work lamp ..... 267, 353-354  
 Wrap ..... 223  
 1st Gear ..... 229  
 2-stroke mixing tool ..... 219  
 50A Anderson plug ..... 347  
 50A connector accessories ..... 278-279, 326-327, 347  
 50A heavy duty connector ..... 347





# Griffiths Equipment Limited

Distributors of Quality Automotive & Marine Products

19 Bell Avenue, Mount Wellington,  
Auckland 1060, New Zealand

PO Box 12556 Penrose,  
Auckland 1642, New Zealand

Email [sales@griffithsequipment.co.nz](mailto:sales@griffithsequipment.co.nz)

Website [griffithsequipment.co.nz](http://griffithsequipment.co.nz)

Phone +64 9 525 4575



## EDITION 62



9 415553 127479

**M GELCAT62**

**NARVA**<sup>®</sup>

**PROJECTA**

**WILDCAT**

**Aerpro**  
First Choice

**JB WELD**

**rainx**

**KICKER**

**GATER**

**PLASTI DIP**

**TRADIES**

TOURING ITEMS  
**TYPES**

CABLE  
**KT**  
ACCESSORIES

**KT SOLAR**

**K-Seal**

**Dexter STEVE**

**BIG WIPES**

**MAP**  
KEYS & REMOTES

**ALL BLACKS**

**BIG RED GEAR**

**JELLY JETSE**  
AIR FRESHENER